

SAMPLE PRESERVATION & STORAGE SOLUTIONS

Innovative Laboratory Consumables and Equipment

**SERVING SCIENTISTS
SINCE 1984**

**CERTIFIED CLASS 7 CLEAN ROOM
MANUFACTURING**

**PRODUCTION IN
THE NETHERLANDS AND
THE UNITED STATES**



About Micronic

Our goal is to advance research by serving scientists in finding solutions that contribute to a higher quality of life. We develop and manufacture a range of Dutch-designed products to enhance the process of sample preservation and storage.

Micronic is an independent organization with its headquarters located in Lelystad, the Netherlands. At Micronic, we develop and manufacture our premium labware and precision engineered equipment in-house. We are committed to offering top-of-the-line products, delivering exceptional quality, reliability and durability. Above all, we stand behind our solutions and are confident that you will too. Our products are applied worldwide in the research laboratories of university hospitals, forensics, agricultural, veterinary and governmental institutes, as well as companies in biotech, food, chemical and pharmaceutical industries.

Production and quality characteristics

- Environmental commitment: Micronic is aware of its interconnectedness with the environment. We continuously think about how we can operate our business in a way that is friendly to this natural environment and sustainable to the earth, and we act accordingly. In addition, Micronic constantly strives to utilize and develop solutions that minimize the impact on the environment – whether it is an energy efficient injection molding machine, plastic recycling, eco-friendly packaging, or high-density products that promote efficiency at our customers' sites.
- ISO 9001:2015 and 14001:2015 certified: All Micronic's businesses, located in the Netherlands and the United States are certified for ISO 9001:2015. Micronic Manufacturing, which produces the sample storage labware is certified for ISO 14001:2015.
- Class 7 clean room: Micronic labware is manufactured and assembled in a NEN-EN-ISO 14644-1 Class 7 certified clean room environment (comparable to US Federal Standard 209E Class 10,000).
- FDA approved and virgin material: Materials are FDA approved and comply with the (USA) USP XXII tests, including class VI (Medical approved), and the European Pharmacopoeia-monograph 3.2.2 unless communicated otherwise.
- Extractables: The materials used for Micronic tubes are the result of extensive research. One selection criterion is that no measurable amount of extractables should leach into samples.
- RNase and DNase: By maintaining the highest possible hygiene level during our production processes, Micronic manufactured labware is free of any detectable RNase or DNase contamination.
- Endotoxin (pyrogen): By maintaining the highest possible hygiene level during its production processes, Micronic is able to limit the endotoxin level of produced and packaged labware to an acceptable minimum (< 0.01 EU/ml).
- CE label: Micronic labware products are developed and manufactured in compliance with the European Directive 98/79/EC, Annex III.
- Sterilization: Micronic products can be supplied gamma irradiated or ethylene oxide treated.

CONTENTS

SAMPLE STORAGE TUBES	4
Superior features	5
Tube overview and specifications	6
Tubes with internal thread (96-well, 48-well and 24-well format)	11
Tubes with external thread (96-well, 48-well and 24-well format)	19
Tubes with external thread hybrid (96-well, 48-well and 24-well format)	30
Special tubes (tubestrip-8 and light sensitive tubes)	37
SAMPLE STORAGE RACKS	46
Superior features	47
Rack overview and specifications	48
96-well format racks	52
48-well format racks	54
24-well format racks	56
Special racks	58
SAMPLE STORAGE CAPS	60
Superior features	61
Cap overview and specifications	62
Screw Caps	64
TPE Push Caps	66
EVA Push Caps	67
SAMPLE HANDLING EQUIPMENT	70
Equipment Service & Warranty	71
Equipment overview and specifications	72
Tube Readers - Single Tube	75
Rack Readers - Single Rack	77
Push Cap Cappers & Decapper	79
Screw Cap Recappers	82
Tube Handler	86
SAMPLE STORAGE STARTER PACKS	90
Overview Starter Packs	92
INNOVATION AT MICRONIC	94





Serving
scientists
since 1984

Certified
Class 7 clean
room manu-
facturing

SAMPLE STORAGE TUBES

Micronic offers a complete line of sample storage tubes that fit in the 138-well, 96-well, 48-well or 24-well ANSI / SLAS standard (formerly recognized as the ANSI / SBS standard) rack format. The comprehensive range includes tubes with volumes ranging from 0.30ml to 6.00ml which are suitable for the most common laboratory storage applications. The tubes are available Non-coded, Alphanumeric coded or with a unique 2D Data-Matrix code (adhere to the ECC200 standard) on the tube bottom, which can be combined with a 1D barcode on the tube side. In addition, Micronic offers a variety of special tubes including the Tubestrip-8 and Amber tubes for light sensitive samples. Through our line of compatible storage racks, sealing products and equipment Micronic is able to offer you a complete solution.



Superior features of Micronic Sample Storage Tubes

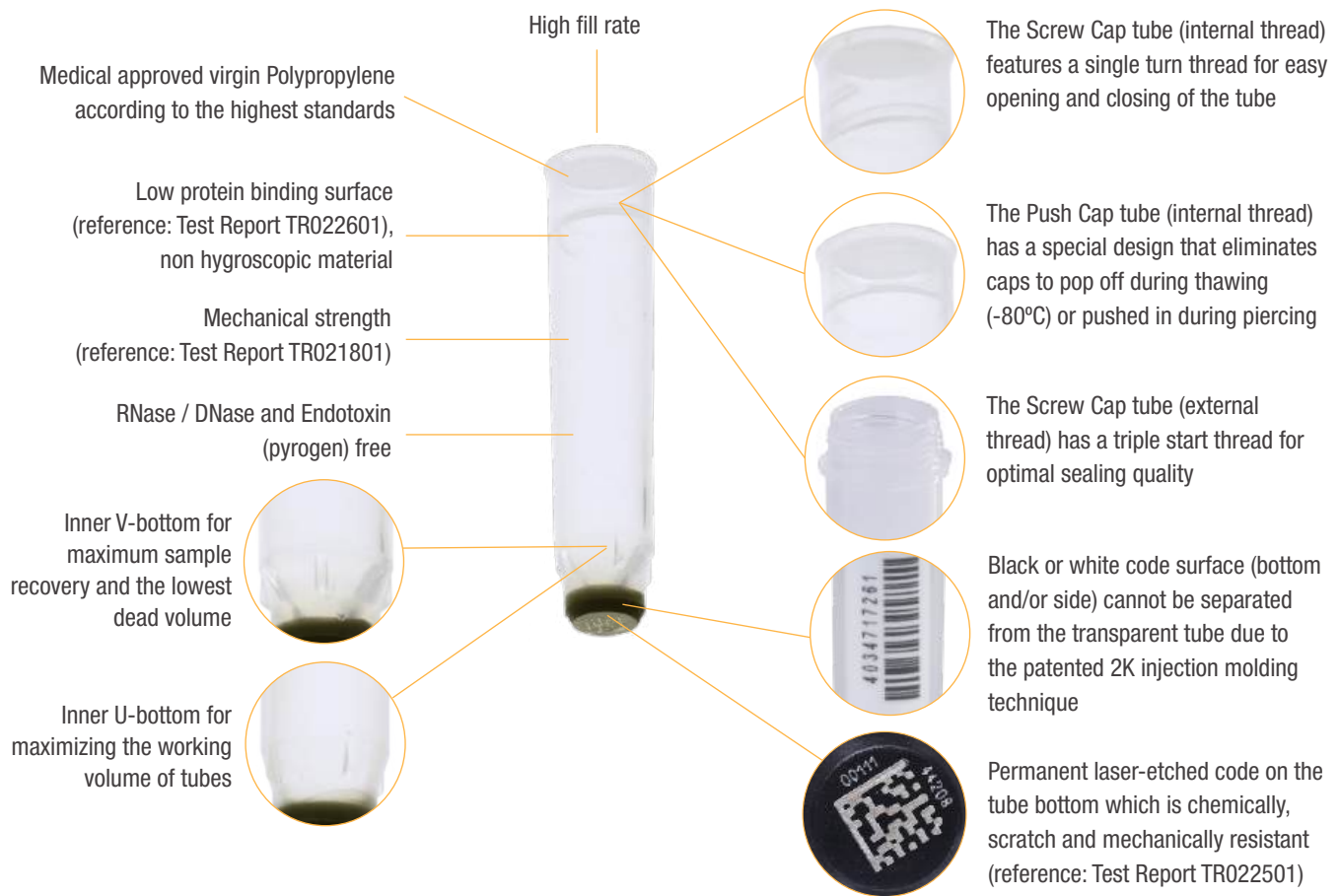

Unique manufacturing process

All Micronic sample storage tubes are manufactured to industry leading strict tolerances. Due to the unique 2K injection molding technique, the highly transparent tube and the code surface are molded to one component leading to the following advantages:

- Code surface cannot be separated from the transparent tube enabling absolute traceability
- Solid and uniform walls allow maximum working volume
- No contamination during the production process







Micronic's high quality and strong sample storage tubes are able to withstand:

- *Multiple freeze-thaw cycles.*

Extensive freeze-thaw tests are conducted with Micronic sample storage tubes and results show no leakages for both Micronic Push Cap tubes and Micronic Screw Cap tubes closed with TPE caps. Additionally, research also shows that no Micronic TPE caps pop off during the freeze-thaw process (reference: Test Report TR021901).

- *Grinding of samples by high speed bead beating for DNA/RNA extraction.*

When homogenizing samples, beads are often used to break open cell walls and membranes to release the desired DNA and RNA. The solid walls of Micronic tubes have been tested and are able to withstand the process of bead beating easily (reference: Test Report TR021801 and TR022701).

	0.50 ML	0.75 ML	0.75 ML	1.10 ML	1.40 ML	1.40 ML
						
Storage rack	Micronic 96-1/Q1	Micronic 96-2	Micronic 96-2	Micronic 96-3	Comorack-96 Micronic 96-4	Micronic 96-4
Ultra low temperature rack						
Optional (DM = 2D Data-Matrix code on rack bottom)	DM	DM	DM	DM	DM	DM
Thread type	Internal	Internal	n/a	Internal	n/a	n/a
Tube type	Screw Cap tube	Screw Cap tube	Push Cap tube	Screw Cap tube	Push Cap tube	Push Cap tube
Inner tube shape	V	V	V or U	V	U	V or U
Working volume with Push Cap (+21°C)*	0.30ml	0.58ml	0.56 or 0.59ml	0.90ml	1.14ml	1.13 or 1.19ml
Working volume with Push Cap (-20°C)*	0.30ml	0.53ml	0.53 or 0.53ml	0.79ml	1.01ml	1.04 or 1.05ml
Working volume with Push Cap (-80°C)*	0.30ml	0.55ml	0.51 or 0.55ml	0.80ml	0.95ml	1.01 or 0.99ml
Working volume with Screw Cap (+21°C)*	0.21ml	0.48ml	n/a	0.80ml	n/a	n/a
Working volume with Screw Cap (-20°C)*	0.21ml	0.48ml	n/a	0.78ml	n/a	n/a
Working volume with Screw Cap (-80°C)*	0.21ml	0.48ml	n/a	0.73ml	n/a	n/a
2D Data-Matrix coded (bottom)	Yes	Yes	Yes	Yes	No	Yes
Alphanumeric coded (bottom)	Yes	Yes	Yes	No	Yes	Yes
Non-coded (bottom)	Yes	Yes	Yes	Yes	Yes	Yes
Human readable coded (bottom)	Yes	Yes	Yes	Yes	No	Yes
Capping options (SC = Screw Cap)	Low Profile SC Screw Cap Push Cap	Low Profile SC Screw Cap Push Cap	Push Cap	Low Profile SC Screw Cap Push Cap	Push Cap	Push Cap
Outer diameter	9.0mm	9.0mm	9.0mm	9.0mm	9.0mm	9.0mm
Tube height	18.5mm	26.0mm	26.0mm	36.5mm	44.0mm	44.0mm
Tube height with Push Cap**	19.5mm	27.0mm	27.0mm	37.5mm	45.0mm	45.0mm
Tube height with Screw Cap	26.0mm	33.5mm	n/a	44.0mm	n/a	n/a
Available precapped	Yes	Yes	Yes	Yes	Yes	Yes
Twist-lock	Yes	Yes	No	Yes	No	No
Snap tube option	Yes	Yes	Yes	Yes	No	Yes (V-bottom)
Sterilization option	Yes	Yes	Yes	Yes	Yes	Yes
DNase / RNase free	Yes	Yes	Yes	Yes	Yes	Yes
Class 7 clean room production	Yes	Yes	Yes	Yes	Yes	Yes
Minimum storage temperature***	Vapor phase LN2	Vapor Phase LN2	-80°C	Vapor phase LN2	-80°C	-80°C
Availability	Bulk, Rack	Bulk, Refill, Rack	Bulk, Refill, Rack	Bulk, Rack	Bulk, Refill, Rack	Bulk, Refill, Rack

* If more sample volume is used in a tube than the specified working volume, it could be possible that deformation of the tube occurs. Request Test Report TR023201 for more information.

** Also applicable for the Low Profile Screw Cap.

*** Temperature range of the material of the tubes, caps and racks is approved from -80°C to +100°C. In practice tubes are used in lower temperatures until *vapor phase* LN2 (-150°C to -196°C). Micronic does not recommend to store tubes in liquid phase nitrogen (LN2). In practice tubes are only snap frozen in LN2 (without submerging the cap).

**** For -80°C storage of the 2.00ml tube its recommended to always use a rack with cover.





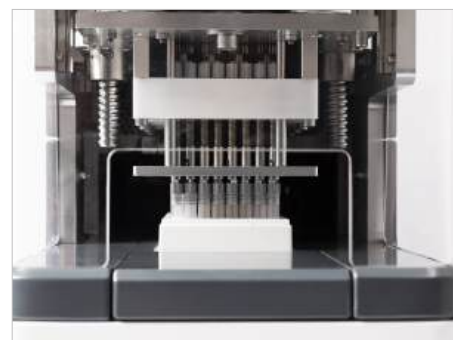

OVERVIEW AND SPECIFICATIONS TUBES WITH INTERNAL THREAD

				Hybrid
1.40 ML	2.00 ML	4.00 ML	6.00 ML	1.40 ML
 Page 15	 Page 16	 Page 17	 Page 18	
Micronic 96-4 DM	Micronic 96-5	Micronic 48-4	Micronic 24-4	Micronic 96-4 DM
Internal Screw Cap tube V or U	Internal Screw Cap tube U	Internal Screw Cap tube Flat	Internal Screw Cap tube Flat	Internal Hybrid tube V
1.15 or 1.20ml 1.01 or 1.05ml 0.95 or 1.06ml 1.04 or 1.10ml 1.00 or 1.06ml 1.01 or 0.98ml	1.58ml 1.39ml 1.40ml**** 1.49ml 1.38ml 1.25ml****	n/a n/a n/a 2.70ml 2.65ml 2.45ml	n/a n/a n/a 4.80ml 4.10ml 3.60ml	
Yes Yes Yes Yes	Yes Yes No Yes	Yes Yes Yes Yes	Yes No Yes Yes	Yes No No
Low Profile SC Screw Cap Push Cap	Low Profile SC Screw Cap Push Cap	Screw Cap	Screw Cap	Low Profile SC Screw cap Push Cap
9.0mm 44.0mm 45.0mm 51.5mm	9.0mm 59.0mm 60.0mm 66.5mm	13.0mm 44.0mm n/a 51.0mm	16.3mm 43.4mm n/a 51.4mm	
Yes Yes Yes Yes Yes Yes	Yes Yes Yes Yes Yes	Yes Yes No Yes Yes Yes	Yes Yes No Yes Yes Yes	Yes Yes Yes Yes Yes
Vapor phase LN2 Bulk, Refill, Rack	-80°C**** Bulk, Rack	Vapor phase LN2 Bulk, Rack	Vapor phase LN2 Bulk, Rack	Vapor phase LN2 Bulk, Rack

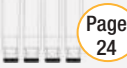

INTERNAL THREAD

SAMPLE STORAGE TUBES

	0.30 ML	0.40 ML	0.75 ML	0.80 ML	1.10 ML	1.40 ML
	 Page 20	 Page 21	 Page 22	 Page 23	 Page 24	 Page 25
Ultra low temperature rack Optional (DM = 2D Data-Matrix code on rack bottom)	Micronic 96-1 DM	Micronic 96-1 DM	Micronic 96-2 DM	Micronic 96-3 DM	Micronic 96-3 DM	Micronic 96-4 DM
Thread type	External	External	External	External	External	External
Tube type	Screw Cap tube	Screw Cap tube	Screw Cap tube	Screw Cap tube	Screw Cap tube	Screw Cap tube
Inner tube shape	V / Vr	V	V	V	V	V
Working volume with Push Cap (+21°C)*	0.25ml / 0.20ml	0.38ml	0.57ml	0.68ml	0.85ml	1.03ml
Working volume with Screw Cap (+21°C)*	0.32ml / 0.23ml	0.40ml	0.60ml	0.75ml	0.93ml	1.11ml
Working volume with Screw Cap (-20°C)*	0.25ml / 0.23ml	0.38ml	0.55ml	0.65ml	0.87ml	1.05ml
Working volume with Screw Cap (-80°C)*	0.25ml / 0.23ml	0.36ml	0.55ml	0.65ml	0.77ml	0.94ml
2D Data-Matrix coded (bottom)	Yes	Yes	Yes	Yes	Yes	Yes
Alphanumeric coded (bottom)	No	No	No	No	No	No
Non-coded (bottom)	No	No	Yes	No	No	Yes
Human readable coded (bottom)	Yes	Yes	Yes	Yes	Yes	Yes
Capping options	Screw Cap (IG) Push Cap	Screw Cap (IG) Push Cap	Screw Cap (IG) Push Cap	Screw Cap (IG) Push Cap	Screw Cap (IG) Push Cap	Screw Cap (IG) Push Cap
Outer diameter	8.8mm	8.8mm	9.0mm	8.8mm	9.0mm	9.0mm
Tube height	16.4mm	21.8mm	30.0mm	34.8mm	41.0mm	48.0mm
Tube height with Push Cap	17.8mm	23.2mm	31.4mm	36.2mm	42.7mm	49.4mm
Tube height with Screw Cap IG	18.7mm	24.1mm	32.3mm	37.0mm	43.6mm	50.3mm
Tube height with Screw Cap	19.9mm	25.3mm	33.5mm	38.3mm	44.6mm	51.5mm
Available precapped	Yes	Yes	Yes	Yes	Yes	Yes
Twist-lock	Yes	Yes	Yes	Yes	Yes	Yes
Snap tube option	No	No	No	No	No	No
Sterilization option	Yes	Yes	Yes	Yes	Yes	Yes
DNase / RNase free	Yes	Yes	Yes	Yes	Yes	Yes
Class 7 clean room production	Yes	Yes	Yes	Yes	Yes	Yes
Minimum storage temperature**	Vapor phase LN2	Vapor phase LN2	Vapor phase LN2	Vapor phase LN2	Vapor phase LN2	Vapor phase LN2
Availability	Bulk, Rack	Bulk, Rack	Bulk, Rack	Bulk, Rack	Bulk, Rack	Bulk, Rack

* If more sample volume is used in a tube than the specified working volume, it could be possible that deformation of the tube occurs. Request Test Report TR023201 for more information.

** Temperature range of the material of the tubes, caps and racks is approved from -80°C to +100°C. In practice tubes are used in lower temperatures until *vapor phase* LN2 (-150°C to -196°C). Micronic does not recommend to store tubes in liquid phase nitrogen (LN2). In practice tubes are only snap frozen in LN2 (without submerging the cap).

*** For -80°C storage of the 2.00ml tube its recommended to always use a rack with cover.

OVERVIEW AND SPECIFICATIONS







TUBES WITH EXTERNAL THREAD

2.00 ML	1.00 ML	4.00 ML	3.50 ML
 Page 26	 Page 27	 Page 28	 Page 29
Micronic 96-5	Micronic 48-1	Micronic 48-4	Micronic 24-2
External Screw Cap tube V	External Screw Cap tube Flat	External Screw Cap tube Flat	External Screw Cap tube Flat
1.48ml 1.55ml 1.25ml 1.25ml	n/a 0.85ml 0.85ml 0.85ml	n/a 3.40ml 3.00ml 3.00ml	n/a 3.35ml 3.05ml 3.05ml
Yes No No Yes	Yes No No Yes	Yes No No Yes	Yes No No Yes
Screw Cap (IG) Push Cap	Screw Cap	Screw Cap	Screw Cap
9.0mm 63.0mm 64.4mm 65.3mm 66.5mm	13.0mm 16.0mm n/a n/a 19.7mm	13.0mm 48.0mm n/a n/a 51.5mm	16.3mm 30.0mm n/a n/a 33.5mm
Yes Yes No Yes Yes Yes	Yes Yes No Yes Yes Yes	Yes Yes No Yes Yes Yes	Yes Yes No Yes Yes Yes
-80°C*** Bulk, Rack	Vapor phase LN2 Bulk, Rack	Vapor phase LN2 Bulk, Rack	Vapor phase LN2 Bulk, Rack



EXTERNAL THREAD

SAMPLE STORAGE TUBES

	0.75 ML	1.40 ML	2.00 ML	3.00 ML	1.50 ML	3.00 ML	6.00 ML
	 Page 30	 Page 31	 Page 32	 Page 33	 Page 34	 Page 35	 Page 36
Ultra low temperature rack Optional (DM = 2D Data-Matrix code on rack bottom)	Micronic 96-2 DM	Micronic 96-4 DM	Micronic 48-2	Micronic 48-3	Micronic 24-1	Micronic 24-1	Micronic 24-4
Thread type	External	External	External	External	External	External	External
Tube type	Hybrid tube	Hybrid tube	Hybrid tube	Hybrid tube	Hybrid tube	Hybrid tube	Hybrid tube
Inner tube shape	V	V	Flat	Flat	Flat	Flat	Flat
Working volume with Push Cap (+21°C)*	0.57ml	1.03ml	n/a	n/a	n/a	n/a	n/a
Working volume with Screw Cap (+21°C)*	0.62ml	1.20ml	1.95ml	2.90ml	1.45ml	2.45ml	6.00ml
Working volume with Screw Cap (-20°C)*	0.62ml	1.06ml	1.80ml	2.60ml	1.40ml	2.25ml	5.55ml
Working volume with Screw Cap (-80°C)*	0.60ml	0.95ml	1.65ml	2.60ml	1.30ml	2.25ml	5.30ml
2D Data-Matrix coded (bottom)	Yes	Yes	Yes	Yes	Yes	Yes	Yes
Alphanumeric coded (bottom)	No	No	No	No	No	No	No
Non-coded (bottom)	No	No	No	No	No	No	No
Human readable coded (bottom)	No	No	No	No	No	No	No
1D barcoded (side)	Yes	Yes	Yes	Yes	No	No	Yes
Human readable coded (side)	Yes	Yes	Yes	Yes	Yes	Yes	Yes
Capping options	Screw Cap Push Cap	Screw Cap Push Cap	Screw Cap	Screw Cap	Screw Cap	Screw Cap	Screw Cap
Outer diameter	8.8mm	8.8mm	13.0mm	13.0mm	16.3mm	16.3mm	16.3mm
Tube height	30.0mm	48.0mm	30.0mm	41.0mm	16.0mm	23.0mm	48.0mm
Tube height with Push Cap	31.4mm	49.4mm	n/a	n/a	n/a	n/a	n/a
Tube height with Screw Cap	33.5mm	51.5mm	33.5mm	44.5mm	19.5mm	26.5mm	51.5mm
Available precapped	Yes	Yes	Yes	Yes	Yes	Yes	Yes
Twist-lock	Yes	Yes	Yes	Yes	Yes	Yes	Yes
Snap tube option	No	No	No	No	No	No	No
Sterilization option	Yes	Yes	Yes	Yes	Yes	Yes	Yes
DNase / RNase free	Yes	Yes	Yes	Yes	Yes	Yes	Yes
Class 7 clean room production	Yes	Yes	Yes	Yes	Yes	Yes	Yes
Minimum storage temperature***	Vapor phase LN2	Vapor phase LN2	Vapor phase LN2	Vapor phase LN2	Vapor phase LN2	Vapor phase LN2	Vapor phase LN2
Availability	Bulk, Rack	Bulk, Rack	Bulk, Rack	Bulk, Rack	Bulk, Rack	Bulk, Rack	Bulk, Rack

* If more sample volume is used in a tube than the specified working volume, it could be possible that deformation of the tube occurs. Request Test Report TR023201 for more information.

** Temperature range of the material of the tubes, caps and racks is approved from -80°C to +100°C. In practice tubes are used in lower temperatures until vapor phase LN2 (-150°C to -196°C). Micronic does not recommend to store tubes in liquid phase nitrogen (LN2). In practice tubes are only snap frozen in LN2 (without submerging the cap).

TUBES WITH INTERNAL THREAD

The 0.50ml Tubes with Internal Thread allow you to save between 35% and 50% of your freezer space and are ideal for low volume sample storage. The tube can be sealed with Push Caps and Screw Caps. Sealing 0.50ml Tubes with Low Profile Screw Caps provides an exceptionally efficient storage solution.









Superior features

- Internal thread provides the most optimal sealing for storage at ultra-low temperatures
- Available Non-coded, Alphanumeric coded or with a unique 2D Data-Matrix code which adheres to the ECC200 standard
- Codes are permanently laser etched
- 2D codes also have a human-readable code
- Black code surface cannot be separated from the transparent tube due to the 2K injection molding technique
- Available in bulk, refill, 96-1 and 96-Q1 ULT Rack (DM), which are based on the ANSI / SLAS standards for storage racks
- 100% quality control on all 2D codes
- Highly compact solution to save freezer space
- Class 7 clean room production
- RNase/DNase and Pyrogen free

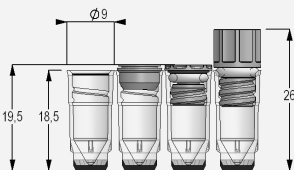
Additional options

- Sterilization using gamma irradiation or Eto treatment
- Snap tubes; tubes are locked into the rack wells to prevent sample loss from overturned racks
- Precapped with (Low Profile) Screw Cap or Push Cap
- Customized 2D Data-Matrix tube code and 1D rack barcode

Specifications

		Working volume at +21°C is 0.21ml (Screw Cap) / 0.30ml (Push Cap)
		V-bottom
		Highest purity Polypropylene
		Tube height is 18.5mm / Tube height in rack is 19.5mm (see page 53 for dim. drawing)
		Resistant to Chemical solvents
		Vapor phase LN2 (with Screw Cap) / -80°C (with Push Cap) to +100°C

Ordering information

More information about product numbers and ordering, see page 38.



The popular 0.75ml Tubes with Internal Thread enable you to store your valuable samples in a safe and traceable way. The tubes are available in a Push Cap and Screw Cap version, and with a variety of codings. The alphanumeric and 2D codes are laser etched into the tube bottom to guarantee sample traceability.



Superior features

- Internal thread provides the most optimal sealing for storage at ultra-low temperatures
- Available Non-coded, Alphanumeric coded or with a unique 2D Data-Matrix code which adheres to the ECC200 standard
- Codes are permanently laser etched
- 2D codes also have a human-readable code
- Black code surface cannot be separated from the transparent tube due to the 2K injection molding technique
- Available in bulk, refill, 96-2 ULT Rack (DM) and 138-2 HD Rack which are based on the ANSI / SLAS standards for storage racks
- 100% quality control on all 2D codes
- Class 7 clean room production
- RNase/DNase and Pyrogen free



Additional options

- Amber tubes for light sensitive samples
- Sterilization using gamma irradiation or Eto treatment
- Snap tubes; tubes are locked into the rack wells to prevent sample loss from overturned racks
- Precapped with (Low Profile) Screw Cap or Push Cap
- Customized 2D Data-Matrix tube code and 1D rack barcode

Specifications

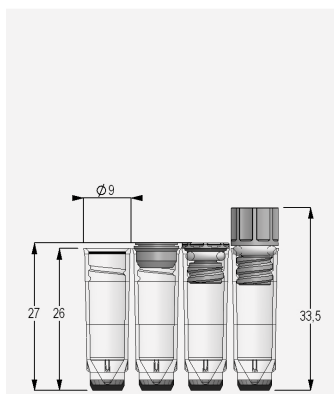

For the working volume, please see 'Tube Overview and Specs' on page 6-7



V-bottom (Screw Cap tube) / V- or U-bottom (Push Cap tube)



Highest purity Polypropylene



Tube height is 26.0mm / Tube height in rack is 27.0mm (see page 53 for dim. drawing)



Resistant to Chemical solvents



Vapor phase LN2 (with Screw Cap) / -80°C (with Push Cap) to +100°C

Ordering information

More information about product numbers and ordering, see page 38.



VIEW PRODUCT ONLINE

The traceable 1.10ml Tubes work equally well with either Screw Caps or Push Caps. The tubes are standard available in the Micronic 96-3 Rack. The 1D barcoded racks are based on the ANSI/SLAS standards for storage racks and are, just like the tubes, produced in a class 7 clean room.



Internal thread

96-well format



Snap tubes







Superior features

- Internal thread provides the most optimal sealing for storage at ultra-low temperatures
- Available Non-coded, Alphanumeric coded or with a unique 2D Data-Matrix code which adheres to the ECC200 standard
- Codes are permanently laser etched
- 2D codes also have a human-readable code
- Black code surface cannot be separated from the transparent tube due to the 2K injection molding technique
- Available in bulk and 96-3 ULT Rack (DM) which is based on the ANSI / SLAS standards for storage racks
- 100% quality control on all 2D codes
- Class 7 clean room production
- RNase/DNase and Pyrogen free

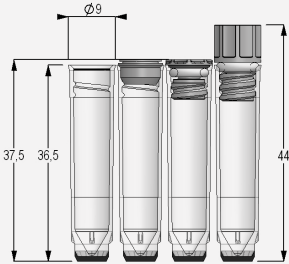
Additional options

- Sterilization using gamma irradiation or Eto treatment
- Snap tubes; tubes are locked into the rack wells to prevent sample loss from overturned racks
- Precapped with (Low Profile) Screw Cap or Push Cap
- Customized 2D Data-Matrix tube code and 1D rack barcode

Specifications

		Working volume at +21°C is 0.80ml (Screw Cap) / 0.90ml (Push Cap)
		V-bottom
		Highest purity Polypropylene
		Tube height is 36.5mm / Tube height in rack is 37.5mm (see page 53 for dim. drawing)
		Resistant to Chemical solvents
		Vapor phase LN2 (with Screw Cap) / -80°C (with Push Cap) to +100°C

Ordering information

More information about product numbers and ordering, see page 39.



1.40ml Non-coded Tubes are proven to be an industry standard solution for many sample storage applications. The tubes provide an affordable way to improve your sample storage, handling and logistic processes. The 1.40ml tubes are also available with code surfaces that cannot be separated from the transparent tube due to a unique 2K injection molding technique.



Superior features

- Internal thread provides the most optimal sealing for storage at ultra-low temperatures
- Available Non-coded, Alphanumeric coded or with a unique 2D Data-Matrix code which adheres to the ECC200 standard
- Codes are permanently laser etched
- 2D codes also have a human-readable code
- Black code surface cannot be separated from the transparent tube due to the 2K injection molding technique
- Available in bulk, refill, Comorack-96 and 96-4 ULT Rack (DM), which are based on the ANSI / SLAS standards for storage racks
- 100% quality control on all 2D codes
- Class 7 clean room production
- RNase/DNase and Pyrogen free



Additional options

- Amber tubes for light sensitive samples
- Sterilization using gamma irradiation or Eto treatment
- Snap tubes; tubes are locked into the rack wells to prevent sample loss from overturned racks
- Precapped with (Low Profile) Screw Cap or Push Cap
- Customized 2D Data-Matrix tube code and 1D rack barcode

Specifications

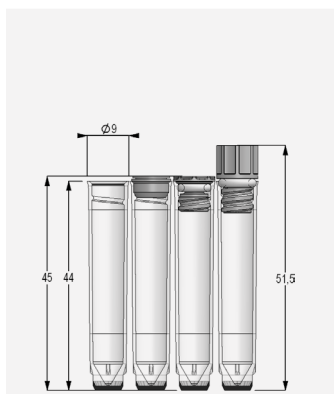

	For the working volumes, please see 'Tube overview and Specs' on page 6-7
	V- or U-bottom (Screw cap tube) / V- or U-bottom (Push cap tube)
	Highest purity Polypropylene
	Tube height is 44.0mm / Tube height in rack is 45.0mm (see page 53 for dim. drawing)
	Resistant to Chemical solvents
	Vapor phase LN2 (with Screw Cap) / -80°C (with Push Cap) to +100°C

Ordering information

More information about product numbers and ordering, see page 39.



VIEW PRODUCT ONLINE

The 2.00ml Tubes combine high sample storage capacity and absolute sample traceability in an industry standard 96-well configuration. The storage tubes are provided with an alphanumeric or unique 2D Data-Matrix code laser encrypted on the tube bottom to enable easy identification and traceable storage of your samples.



Superior features

- Internal thread provides the most optimal sealing for storage at ultra-low temperatures
- Available Alphanumeric coded or with a unique 2D Data-Matrix code which adheres to the ECC200 standard
- Codes are permanently laser etched
- 2D codes also have a human-readable code
- Black code surface cannot be separated from the transparent tube due to the 2K injection molding technique
- Available in bulk and 96-5 ULT Rack which is based on the ANSI / SLAS standards for storage racks
- 100% quality control on all 2D codes
- Class 7 clean room production
- RNase/DNase and Pyrogen free



Additional options

- Sterilization using gamma irradiation or Eto treatment
- Snap tubes; tubes are locked into the rack wells to prevent sample loss from overturned racks
- Precapped with (Low Profile) Screw Cap or Push Cap
- Customized 2D Data-Matrix tube code and 1D rack barcode

Specifications

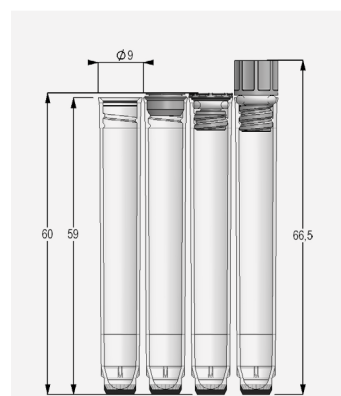

Working volume at +21°C is 1.49ml (Screw Cap) / 1.58ml (Push Cap)

U-bottom

Highest purity Polypropylene

Tube height is 59.0mm / Tube height in rack is 60.0mm (see page 53 for dim. drawing)

Resistant to Chemical solvents

-80°C* to +100°C

* For -80°C storage of the 2.00ml tube it is recommended to always use a rack with cover

Ordering information

More information about product numbers and ordering, see page 40.



Our 4.00ml Tubes in 48-well format are ideal for storing or transporting larger volumes of liquid or solid biological samples. The tubes provide optimal sealing enabling high integrity storage at ultra-low temperatures. Additionally, the tubes are compatible with Micronic Screw Cap Recappers and automated systems.



Superior features

- Internal thread provides the most optimal sealing for storage at ultra-low temperatures
- Available Non-coded, Alphanumeric coded or with a unique 2D Data-Matrix code which adheres to the ECC200 standard
- Codes are permanently laser etched
- 2D codes also have a human-readable code
- Black code surface cannot be separated from the transparent tube due to the 2K injection molding technique
- Available in bulk and 48-4 ULT Rack which is based on the ANSI / SLAS standards for storage racks
- 100% quality control on all 2D codes
- Class 7 clean room production
- 48-format Screw Caps are available in 12 colors
- RNase/DNase and Pyrogen free



Additional options

- Sterilization using gamma irradiation or Eto treatment
- Precapped with Screw Cap
- Customized 2D Data-Matrix tube code and 1D rack barcode

Specifications

		Working volume at +21°C is 2.70ml (Screw Cap)
		Flat bottom
		Highest purity Polypropylene
		Tube height is 44.0mm / Tube height in rack is 45.0mm (see page 55 for dim. drawing)
		Resistant to Chemical solvents
		Vapor phase LN2 to +100°C

Ordering information

More information about product numbers and ordering, see page 40.



VIEW PRODUCT ONLINE

6.00ml Sample Storage Tubes in 24-well format have a large working volume of 4.80ml at +21°C. These tubes are available Non-coded or with a 2D Data-Matrix code. The 2D Data-Matrix code permanently laser-etched on the tube bottom identifies the sample, its coordinates within a 24-tube storage rack, the particular rack and the location of the rack in your freezer.









Superior features

- Internal thread provides the most optimal sealing for storage at ultra-low temperatures
- Available Non-coded or with a unique 2D Data-Matrix code which adheres to the ECC200 standard on the tube bottom
- 2D codes and 1D rack barcodes are permanently laser etched
- A large human-readable code next to the 2D code
- Black code surface cannot be separated from the transparent tube due to the 2K injection molding technique
- Available in bulk and 24-4 ULT Rack which is based on the ANSI / SLAS standards for storage racks
- 24-format Screw Caps are available in 12 colors
- 100% quality control on all 2D codes
- Class 7 clean room production
- RNase/DNase and Pyrogen free

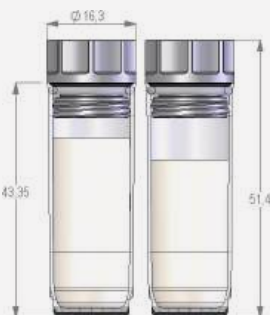
Additional options

- Sterilization using gamma irradiation or Eto treatment
- Precapped with Screw Cap
- Customized 2D Data-Matrix tube code and 1D rack barcode

Specifications

		Working volume at +21°C is 4.80ml (Screw Cap)
		Flat bottom
		Highest purity Polypropylene
		Tube height is 43.4mm / Tube height in rack is 44.0mm (see page 57 for dim. drawing)
		Resistant to Chemical solvents
		Vapor phase LN2 to +100°C

Ordering information

More information about product numbers and ordering, see page 40.



The 1.40ml internally threaded hybrid tube enables you to store your samples in a safe and traceable way with the 4 coding concepts. Samples can be identified with the 2D Data-Matrix code, 1D barcode, numeric code and by written codes on the white tube surface, which are permanently laser-etched into the white surfaces, so that they can never wear or fall off.









Superior features

- Internal thread provides the most optimal sealing for storage at ultra-low temperatures
- 1D barcode/human readable code on the tube side wall for visual identification or verification
- Available with a unique 2D Data-Matrix code which adheres to the ECC standards permanently laser etched on the tube bottom
- 2D codes also have a human-readable code
- White code surface cannot be separated from the transparent tube due to the 2K injection molding technique
- Available in bulk and 96-4 ULT Rack (DM), which is based on the ANSI / SLAS standards for storage racks
- 96-format Screw Caps are available in 12 colors
- 100% quality control on all 2D codes
- Class 7 clean room production
- RNase/DNase and Pyrogen free

Additional options

- Sterilization using gamma irradiation or Eto treatment
- Precapped with (Low Profile) Screw Cap or Push Cap
- Customized tube codes and rack barcode

Specifications

	Working volume at +21°C is 4.80ml (Screw Cap)
	V bottom
	Highest purity Polypropylene
	Tube height is 43.4mm / Tube height in rack is 44.0mm (see page 57 for dim. drawing)
	Resistant to Chemical solvents
	Vapor phase LN2 to +100°C

Ordering information

More information about product numbers and ordering, see page 40.



TUBES WITH EXTERNAL THREAD

To address the need for low volume genomics, the 0.30ml Tube enables miniaturization of reaction volume required in genomic applications. The automation friendly tube cuts out intermediate (screening) plates and is more accessible for low volume liquid handlers. Ideal for DNA/RNA libraries, unique aliquoting and storage capacity with multi access.



Superior features







- External thread for minimum cross contamination and maximum working volume
- Triple thread for optimal sealing quality
- Thick tube walls, sturdy design and excellent properties for ultra-low temperature storage
- Available with a unique 2D Data-Matrix code which adheres to the ECC standards permanently laser etched on the tube bottom
- 2D codes also have a human-readable code
- Black code surface cannot be separated from the transparent tube due to the 2K injection molding technique
- Available in bulk and 96-1 ULT Rack (DM) which is based on the ANSI / SLAS standards for storage racks
- 100% quality control on all 2D codes
- Class 7 clean room production
- RNase/DNase and Pyrogen free



Additional options

- Sterilization using gamma irradiation or Eto treatment
- Precapped with Screw Cap (IG) or Push Cap
- Customized 2D Data-Matrix tube code and 1D rack barcode

Specifications

	For the working volumes, please see 'Tube Overview and Specs' on page 8-9
	Vr- or V-bottom
	Highest purity Polypropylene
	Tube height is 16.4mm / Tube height in rack is 17.4mm (see page 53 for dim. drawing)
	Resistant to Chemical solvents
	Vapor phase LN2 to +100°C

Ordering information

More information about product numbers and ordering, see page 40.



The 0.40ml Tube enables efficient storage of low volumes of liquid samples. Due to thick tube walls, the tube has a sturdy design and excellent properties for ultra-low temperature storage. The 2D Data-Matrix codes are permanently laser-etched into the tube bottom so that they can never wear or fall off, ensuring absolute traceability.









Superior features

- External thread for minimum cross contamination and maximum working volume
- Triple thread for optimal sealing quality
- Thick tube walls, sturdy design and excellent properties for ultra-low temperature storage
- Available with a unique 2D Data-Matrix code which adheres to the ECC standards permanently laser etched on the tube bottom
- 2D codes also have a human-readable code
- Black code surface cannot be separated from the transparent tube due to the 2K injection molding technique
- Available in bulk and 96-1 ULT Rack (DM) which is based on the ANSI / SLAS standards for storage racks
- 100% quality control on all 2D codes
- Class 7 clean room production
- RNase/DNase and Pyrogen free

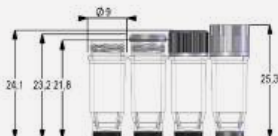
Additional options

- Sterilization using gamma irradiation or Eto treatment
- Precapped with Screw Cap (IG) or Push Cap
- Customized 2D Data-Matrix tube code and 1D rack barcode

Specifications

		Working volume at +21°C is 0.40ml (Screw Cap) / 0.38ml (Push Cap)
		V-bottom
		Highest purity Polypropylene
		Tube height is 21.8mm / Tube height in rack is 22.8mm (see page 53 for dim. drawing)
		Resistant to Chemical solvents
		Vapor phase LN2 to +100°C

Ordering information

More information about product numbers and ordering, see page 41.



Our externally threaded 0.75ml Tubes are provided with a triple start thread which gives an excellent closure to ensure long term sample preservation and storage. Using externally threaded storage tubes eliminates the possibility of the sample coming into contact with the screw thread, minimizing chance of cross-contamination while improving sample integrity.



Superior features

- External thread for minimum cross contamination and maximum working volume
- Triple thread for optimal sealing quality
- Thick tube walls, sturdy design and excellent properties for ultra-low temperature storage
- Available with a unique 2D Data-Matrix code which adheres to the ECC standards permanently laser etched on the tube bottom
- 2D codes also have a human-readable code
- Black code surface cannot be separated from the transparent tube due to the 2K injection molding technique
- Available in bulk, 96-2 ULT Rack (DM) and 138-2 HD Rack which are based on the ANSI / SLAS standards for storage racks
- 100% quality control on all 2D codes
- Class 7 clean room production
- RNase/DNase and Pyrogen free

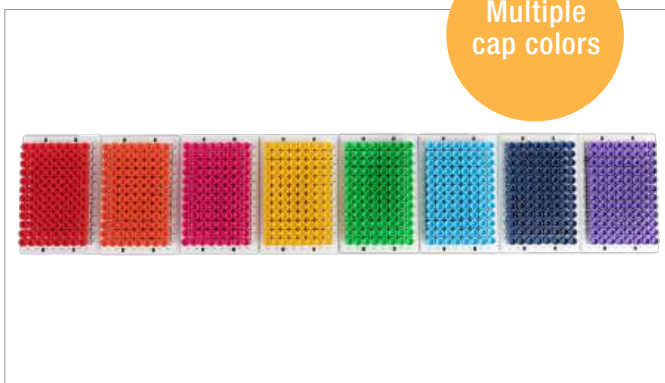

Additional options

- Sterilization using gamma irradiation or Eto treatment
- Precapped with Screw Cap (IG) or Push Cap
- Customized 2D Data-Matrix tube code and 1D rack barcode

Specifications

		Working volume at +21°C is 0.60ml (Screw Cap) / 0.57ml (Push Cap)
		V-bottom
		Highest purity Polypropylene
		Tube height is 30.0mm / Tube height in rack is 31.0mm (see page 53 for dim. drawing)
		Resistant to Chemical solvents
		Vapor phase LN2 to +100°C

Ordering information

More information about product numbers and ordering, see page 41.



VIEW PRODUCT ONLINE

The space efficient 0.80ml Sample Tubes can hold a high (net) volume of biomaterial while occupying a relatively small amount of space, maximizing storage volume. Additionally, the code surface features a raised edge, which protects the 2D code against accidental scratches, ensuring absolute traceability.



Superior features

- External thread for minimum cross contamination and maximum working volume
- Triple thread for optimal sealing quality
- Thick tube walls, sturdy design and excellent properties for ultra-low temperature storage
- Available with a unique 2D Data-Matrix code which adheres to the ECC standards permanently laser etched on the tube bottom
- 2D codes also have a human-readable code
- Black code surface cannot be separated from the transparent tube due to the 2K injection molding technique
- Available in bulk, 96-3 ULT Rack (DM) and 138-2 HD Rack which are based on the ANSI / SLAS standards for storage racks
- 100% quality control on all 2D codes
- Class 7 clean room production
- RNase/DNase and Pyrogen free

Additional options

- Sterilization using gamma irradiation or Eto treatment
- Precapped with Screw Cap (IG) or Push Cap
- Customized 2D Data-Matrix tube code and 1D rack barcode

Specifications

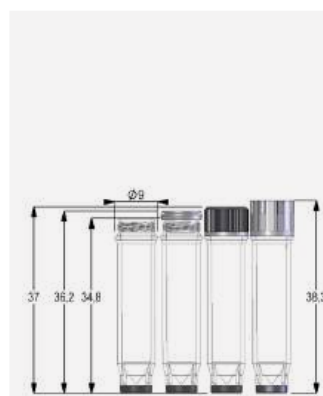

Working volume at +21°C is 0.75ml (Screw Cap) / 0.68ml (Push Cap)

V-bottom

Highest purity Polypropylene

Tube height is 34.8mm / Tube height in rack is 35.8mm (see page 53 for dim. drawing)

Resistant to Chemical solvents

Vapor phase LN2 to +100°C

Ordering information

More information about product numbers and ordering, see page 41.



The triple thread of the 1.10ml Tubes External Thread gives an excellent closure and horizontal placement of the cap to ensure long-term sample preservation and storage. The code surface of the tubes with external thread features a raised edge, which protects the 2D code against accidental scratches, ensuring absolute traceability.



Superior features

- External thread for minimum cross contamination and maximum working volume
- Triple thread for optimal sealing quality
- Thick tube walls, sturdy design and excellent properties for ultra-low temperature storage
- Available with a unique 2D Data-Matrix code which adheres to the ECC standards permanently laser etched on the tube bottom
- 2D codes also have a human-readable code
- Black code surface cannot be separated from the transparent tube due to the 2K injection molding technique
- Available in bulk and 96-3 ULT Rack (DM) which is based on the ANSI / SLAS standards for storage racks
- 100% quality control on all 2D codes
- Class 7 clean room production
- RNase/DNase and Pyrogen free



Additional options

- Sterilization using gamma irradiation or Eto treatment
- Precapped with Screw Cap (IG) or Push Cap
- Customized 2D Data-Matrix tube code and 1D rack barcode

Specifications

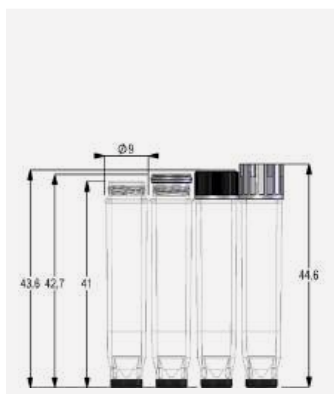

	Working volume at +21°C is 0.93ml (Screw Cap) / 0.85ml (Push Cap)
	V-bottom
	Highest purity Polypropylene
	Tube height is 41.0mm / Tube height in rack is 42.3mm (see page 53 for dim. drawing)
	Resistant to Chemical solvents
	Vapor phase LN2 to +100°C

Ordering information

More information about product numbers and ordering, see page 42.



VIEW PRODUCT ONLINE

To anticipate on the trend to store samples in cryogenic temperatures, the 1.40ml Tubes with External Thread have a sturdy design and thick tubes walls - excellent properties for ultra-low temperature storage. Using externally threaded storage tubes eliminates the possibility of the sample coming into contact with the screw thread, improving sample integrity.



Superior features

- External thread for minimum cross contamination and maximum working volume
- Triple thread for optimal sealing quality
- Thick tube walls, sturdy design and excellent properties for ultra-low temperature storage
- Available with a unique 2D Data-Matrix code which adheres to the ECC standards permanently laser etched on the tube bottom
- 2D codes also have a human-readable code
- Black code surface cannot be separated from the transparent tube due to the 2K injection molding technique
- Available in bulk and 96-4 ULT Rack (DM) which is based on the ANSI / SLAS standards for storage racks
- 100% quality control on all 2D codes
- Class 7 clean room production
- RNase/DNase and Pyrogen free



Additional options

- Sterilization using gamma irradiation or Eto treatment
- Precapped with Screw Cap (IG) or Push Cap
- Customized 2D Data-Matrix tube code and 1D rack barcode

Specifications

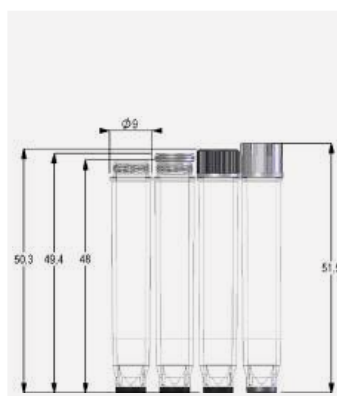

Working volume at +21°C is 1.11ml (Screw Cap) / 1.03ml (Push Cap)

V-bottom

Highest purity Polypropylene

Tube height is 48.0mm / Tube height in rack is 49.0mm (see page 53 for dim. drawing)

Resistant to Chemical solvents

Vapor phase LN2 to +100°C

Ordering information

More information about product numbers and ordering, see page 42.



Our unmatched 2.00ml Tubes are ideal to store and handle high volume samples in an industry standard 96-well configuration. The triple thread of the tube with external thread gives an excellent closure and horizontal placement of the cap to ensure long-term sample preservation and storage.



Superior features

- External thread for minimum cross contamination and maximum working volume
- Triple thread for optimal sealing quality
- Thick tube walls, sturdy design and excellent properties for ultra-low temperature storage
- Available with a unique 2D Data-Matrix code which adheres to the ECC standards permanently laser etched on the tube bottom
- 2D codes also have a human-readable code
- Black code surface cannot be separated from the transparent tube due to the 2K injection molding technique
- Available in bulk and 96-5 ULT Rack which is based on the ANSI / SLAS standards for storage racks
- 100% quality control on all 2D codes
- Class 7 clean room production
- RNase/DNase and Pyrogen free

Additional options

- Sterilization using gamma irradiation or Eto treatment
- Precapped with Screw Cap (IG) or Push Cap
- Customized 2D Data-Matrix tube code and 1D rack barcode

Specifications



	Working volume at +21°C is 1.55ml (Screw Cap) / 1.48ml (Push Cap)
	V-bottom
	Highest purity Polypropylene
	Tube height is 63.0mm / Tube height in rack is 63.8mm (see page 53 for dim. drawing)
	Resistant to Chemical solvents
	-80°C to +100°C

* For -80°C storage of the 2.00ml tube it is recommended to always use a rack with cover

Ordering information

More information about product numbers and ordering, see page 42.



VIEW PRODUCT ONLINE

The Micronic 1.00ml Tissue Storage Tube with External Thread is specially designed for the storage of your valuable fresh frozen tissue samples. The 1.00ml tube can store solid samples up to a size of 0.40 x 0.40 x 0.70 cm. A wide shallow opening enables easy loading and removal of tissue samples using tweezers.









Superior features

- External thread for minimum cross contamination and maximum working volume
- Triple thread for optimal sealing quality
- Thick tube walls, sturdy design and excellent properties for ultra-low temperature storage
- Available with a unique 2D Data-Matrix code which adheres to the ECC standards permanently laser etched on the tube bottom
- 2D codes also have a human-readable code
- Transparent Screw Cap available for visual checks
- Black code surface cannot be separated from the transparent tube due to the 2K injection molding technique
- Available in bulk and 48-1 ULT Rack which is based on the ANSI / SLAS standards for storage racks
- 100% quality control on all 2D codes
- Class 7 clean room production
- RNase/DNase and Pyrogen free

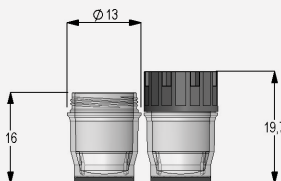
Additional options

- Sterilization using gamma irradiation or Eto treatment
- Precapped with Screw Cap
- Customized 2D Data-Matrix tube code and 1D rack barcode

Specifications

		Working volume at +21°C is 0.85ml (Screw Cap)
		Flat bottom
		Highest purity Polypropylene
		Tube height is 16.0mm / Tube height in rack is 17.0mm (see page 55 for dim. drawing)
		Resistant to Chemical solvents
		Vapor phase LN2 to +100°C

Ordering information

More information about product numbers and ordering, see page 42.



The 4.00ml Tube with External Thread has a massive working volume of 3.40ml (at +21°C). The sample storage tube is ideal for solid or large volumes of liquid samples. The 4.00ml tubes with a 2D Data-Matrix code permanently laser-etched on the bottom of the tube are the storage medium of choice for customers demanding long-term reliable code reading.



External thread

48-well format

Superior features

- External thread for minimum cross contamination and maximum working volume
- Triple thread for optimal sealing quality
- Thick tube walls, sturdy design and excellent properties for ultra-low temperature storage
- Available with a unique 2D Data-Matrix code which adheres to the ECC standards permanently laser etched on the tube bottom
- 2D codes also have a human-readable code
- Transparent Screw Cap available for visual checks
- Black code surface cannot be separated from the transparent tube due to the 2K injection molding technique
- Available in bulk and 48-4 ULT Rack which is based on the ANSI / SLAS standards for storage racks
- 100% quality control on all 2D codes
- Class 7 clean room production
- RNase/DNase and Pyrogen free



Ask about code reading options

Additional options

- Sterilization using gamma irradiation or Eto treatment
- Precapped with Screw Cap
- Customized 2D Data-Matrix tube code and 1D rack barcode

Specifications

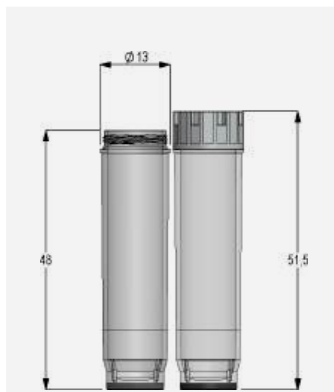

Working volume at +21°C is 3.40ml (Screw Cap)

Flat bottom

Highest purity Polypropylene

Tube height is 48.0mm / Tube height in rack is 49.0mm (see page 55 for dim. drawing)

Resistant to Chemical solvents

Vapor phase LN2 to +100°C

Ordering information

More information about product numbers and ordering, see page 43.



VIEW PRODUCT ONLINE

3.50ML STORAGE TUBES EXTERNAL THREAD

The 3.50ml Tissue Tube with External Thread is specially designed for the storage of your fresh frozen tissue. The 3.50ml tube can store samples up to a size of 0.95 x 0.95 x 2.40 cm. With this tube, biobanks can take the next step to standardize and automate the storage of fresh frozen tissue samples.



Superior features

- External thread for minimum cross contamination and maximum working volume
- Triple thread for optimal sealing quality
- Thick tube walls, sturdy design and excellent properties for ultra-low temperature storage
- Available with a unique 2D Data-Matrix code which adheres to the ECC standards permanently laser etched on the tube bottom
- 2D codes also have a human-readable code
- Transparent Screw Cap available for visual checks
- Black code surface cannot be separated from the transparent tube due to the 2K injection molding technique
- Available in bulk and 24-2 ULT Rack which is based on the ANSI / SLAS standards for storage racks
- 100% quality control on all 2D codes
- Class 7 clean room production
- RNase/DNase and Pyrogen free

Additional options

- Sterilization using gamma irradiation or Eto treatment
- Precapped with Screw Cap
- Customized 2D Data-Matrix tube code and 1D rack barcode

Specifications

		Working volume at +21°C is 3.35ml (Screw Cap)
		Flat bottom
		Highest purity Polypropylene
		Tube height is 30.0mm / Tube height in rack is 31.2mm (see page 57 for dim. drawing)
		Resistant to Chemical solvents
		Vapor phase LN2 to +100°C

Ordering information

More information about product numbers and ordering, see page 43.

VIEW PRODUCT ONLINE



The Tubes with External Thread Hybrid uniquely combine automated and visual sample identification. The unique combination of coding concepts on the 0.75ml Tube guarantees the complete traceability of samples. The high contrast 1D, 2D and human-readable codes are permanently laser-etched into the white surfaces, so that they can never wear or fall off.



External thread hybrid

96-well format



Combining 4 coding concepts

Superior features

- 1D barcode/human readable code on the tube side wall for visual identification or verification
- Available with a unique 2D Data-Matrix code which adheres to the ECC standards permanently laser etched on the tube bottom
- External thread for minimum cross contamination and maximum working volume
- Triple thread for optimal sealing quality
- Thick tube walls, sturdy design and excellent properties for ultra-low temperature storage
- White code surfaces cannot be separated from the transparent tube due to the 2K injection molding technique
- Available in bulk, 96-2 ULT Rack (DM) and 138-2 HD Rack which are based on the ANSI / SLAS standards for storage racks
- 100% quality control on all 1D and 2D codes
- Class 7 clean room production
- RNase/DNase and Pyrogen free

Additional options

- Sterilization using gamma irradiation or Eto treatment
- Precapped with Screw Cap or Push Cap
- Customized tube codes and rack barcode

Specifications

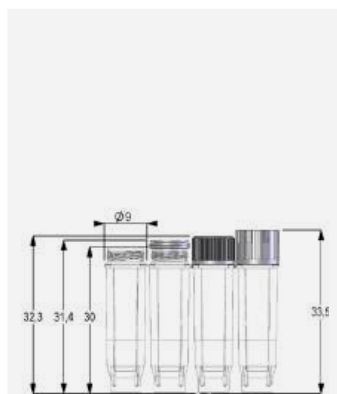

Working volume at +21°C is 0.62ml (Screw Cap) / 0.57ml (Push Cap)

V-bottom

Highest purity Polypropylene

Tube height is 30.0mm / Tube height in rack is 31.0mm (see page 53 for dim. drawing)

Resistant to Chemical solvents

Vapor phase LN₂ to +100°C

Ordering information

More information about product numbers and ordering, see page 43.



VIEW PRODUCT ONLINE

The transparent part of the 1.40ml Hybrid tube walls enables easy visual checking of the sample, while the 4 coding concepts guarantee sample traceability. Samples can be identified with the 2D Data-Matrix code, 1D barcode, numeric code and by written codes on the white tube surface, this enables researchers to verify information and keep identifying samples.



External
thread
hybrid

96-well
format

Superior features







- 1D barcode/human readable code on the tube side wall for visual identification or verification
- Available with a unique 2D Data-Matrix code which adheres to the ECC standards permanently laser etched on the tube bottom
- External thread for minimum cross contamination and maximum working volume
- Triple thread for optimal sealing quality
- Thick tube walls, sturdy design and excellent properties for ultra-low temperature storage
- White code surfaces cannot be separated from the transparent tube due to the 2K injection molding technique
- Available in bulk and 96-4 ULT Rack (DM) which is based on the ANSI / SLAS standards for storage racks
- 100% quality control on all 1D and 2D codes
- Class 7 clean room production
- RNase/DNase and Pyrogen free



Additional options

- Sterilization using gamma irradiation or Eto treatment
- Precapped with Screw Cap or Push Cap
- Customized tube codes and rack barcode

Specifications

		Working volume at +21°C is 1.20ml (Screw Cap) / 1.03ml (Push Cap)
		V-bottom
		Highest purity Polypropylene
		Tube height is 48.0mm / Tube height in rack is 49.0mm (see page 53 for dim. drawing)
		Resistant to Chemical solvents
		Vapor phase LN2 to +100°C

Ordering information

More information about product numbers and ordering, see page 44.



The 2.00ml Tubes with External Thread Hybrid guarantee sample traceability and optimize working volume. The transparent part of the tube walls enable easy visual checking of the sample, while the 4 coding concepts guarantee sample traceability. Samples can be identified with the 2D Data-Matrix code, 1D barcode, numeric code and by written codes on the white tube surfaces.



Superior features

- 1D barcode/ human readable code on the tube side wall for visual identification or verification
- Available with a unique 2D Data-Matrix code which adheres to the ECC standards permanently laser etched on the tube bottom
- External thread for minimum cross contamination and maximum working volume
- Triple thread for optimal sealing quality
- Thick tube walls, sturdy design and excellent properties for ultra-low temperature storage
- White code surfaces cannot be separated from the transparent tube due to the 2K injection molding technique
- Available in bulk and 48-2 ULT Rack which is based on the ANSI / SLAS standards for storage racks
- 100% quality control on all 1D and 2D codes
- Class 7 clean room production
- RNase/DNase and Pyrogen free

Additional options

- Sterilization using gamma irradiation or Eto treatment
- Precapped with Screw Cap
- Customized tube codes and rack barcode

Specifications

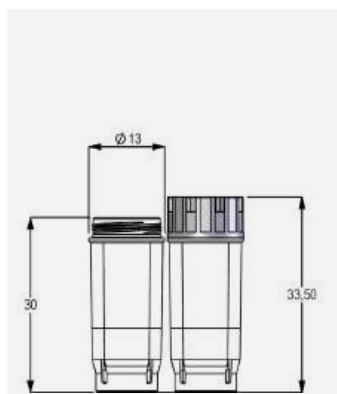

	Working volume at +21°C is 1.95ml (Screw Cap)
	Flat bottom
	Highest purity Polypropylene
	Tube height is 30.0mm / Tube height in rack is 31.0mm (see page 55 for dim. drawing)
	Resistant to Chemical solvents
	Vapor phase LN2 to +100°C

Ordering information

More information about product numbers and ordering, see page 44.



VIEW PRODUCT ONLINE

The 3.00ml Tubes with External Thread Hybrid guarantee sample traceability, optimize working volume and increase overall sample storage efficiency. The unique combination of coding concepts and the dimensions of the tubes make the tubes extremely versatile. The tubes are compatible with ANSI/SLAS format racks, standard 9x9 or 9x10 cyro boxes.



Superior features

- 1D barcode/human readable code on the tube side wall for visual identification or verification
- Available with a unique 2D Data-Matrix code which adheres to the ECC standards permanently laser etched on the tube bottom
- External thread for minimum cross contamination and maximum working volume
- Triple thread for optimal sealing quality
- Thick tube walls, sturdy design and excellent properties for ultra-low temperature storage
- White code surfaces cannot be separated from the transparent tube due to the 2K injection molding technique
- Available in bulk and 48-3 ULT Rack which is based on the ANSI / SLAS standards for storage racks
- 100% quality control on all 1D and 2D codes
- Class 7 clean room production
- RNase/DNase and Pyrogen free

Additional options

- Sterilization using gamma irradiation or Eto treatment
- Precapped with Screw Cap
- Customized tube codes and rack barcode

Specifications

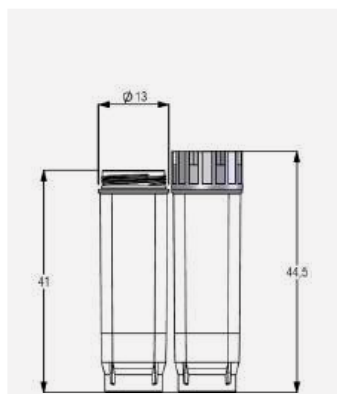

Working volume at +21°C is 2.90ml (Screw Cap)

Flat bottom

Highest purity Polypropylene

Tube height is 41.0mm / Tube height in rack is 42.0mm (see page 55 for dim. drawing)

Resistant to Chemical solvents

Vapor phase LN2 to +100°C

Ordering information

More information about product numbers and ordering, see page 44.



Our 1.50ml Tube in 24-well format is a fully traceable solution to store your valuable biopsy, donor or transplant samples. The tube has an external screw thread, a wide opening and a flat inner bottom, enabling easy loading / removal of tissue samples using tweezers.

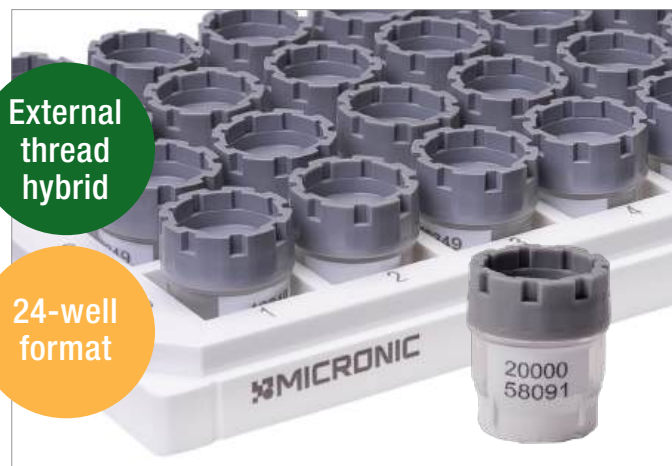

Superior features





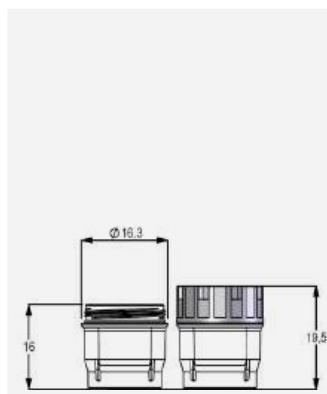

- Numeric human readable code on the tube side wall for visual identification or verification
- Available with a unique 2D Data-Matrix code which adheres to the ECC standards permanently laser etched on the tube bottom
- External thread for minimum cross contamination and maximum working volume
- Triple thread for optimal sealing quality
- Thick tube walls, sturdy design and excellent properties for ultra-low temperature storage
- White code surfaces cannot be separated from the transparent tube due to the 2K injection molding technique
- Available in bulk and 24-1 ULT Rack which is based on the ANSI / SLAS standards for storage racks
- 100% quality control on all 1D and 2D codes
- Class 7 clean room production
- RNase/DNase and Pyrogen free

Additional options

- Sterilization using gamma irradiation or Eto treatment
- Precapped with Screw Cap
- Customized tube codes and rack barcode

Specifications



	Working volume at +21°C is 1.45ml (Screw Cap)
	Flat bottom
	Highest purity Polypropylene
	Tube height is 16.0mm / Tube height in rack is 17.0mm (see page 57 for dim. drawing)
	Resistant to Chemical solvents
	Vapor phase LN2 to +100°C

Ordering information

More information about product numbers and ordering, see page 45.



VIEW PRODUCT ONLINE

The tissue tube is ideal for the storage of solid tissue samples. With a unique 2D Data-Matrix code laser etched on the tube bottom, and a large human readable code on the tube sidewall, the 3.00ml Tissue Tube provides easy and unambiguous identification and storage of your samples.









Superior features

- Numeric human readable code on the tube side wall for visual identification or verification
- Available with a unique 2D Data-Matrix code which adheres to the ECC standards permanently laser etched on the tube bottom
- External thread for minimum cross contamination and maximum working volume
- Triple thread for optimal sealing quality
- Thick tube walls, sturdy design and excellent properties for ultra-low temperature storage
- White code surfaces cannot be separated from the transparent tube due to the 2K injection molding technique
- Available in bulk and 24-1 ULT Rack which is based on the ANSI / SLAS standards for storage racks
- 100% quality control on all 1D and 2D codes
- Class 7 clean room production
- RNase/DNase and Pyrogen free

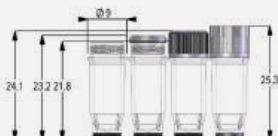
Additional options

- Sterilization using gamma irradiation or Eto treatment
- Precapped with Screw Cap
- Customized tube codes and rack barcode

Specifications

		Working volume at +21°C is 2.45ml (Screw Cap)
		Flat bottom
		Highest purity Polypropylene
		Tube height is 23.0mm / Tube height in rack is 24.0mm (see page 57 for dim. drawing)
		Resistant to Chemical solvents
		Vapor phase LN2 to +100°C

Ordering information

More information about product numbers and ordering, see page 45.



This 6.00ml Tube with External Thread Hybrid in 24-well format enables researchers to store tissue and high volumes of liquid samples. The combination of coding concepts and the dimensions of the tubes provide a secure solution to store samples at low temperatures while guaranteeing sample traceability.



Superior features

- 1D barcode/human readable code on the tube side wall for visual identification or verification
- Available with a unique 2D Data-Matrix code which adheres to the ECC standards permanently laser etched on the tube bottom
- External thread for minimum cross contamination and maximum working volume
- Triple thread for optimal sealing quality
- Thick tube walls, sturdy design and excellent properties for ultra-low temperature storage
- White code surfaces cannot be separated from the transparent tube due to the 2K injection molding technique
- Available in bulk and 24-4 ULT Rack which is based on the ANSI / SLAS standards for storage racks
- 100% quality control on all 1D and 2D codes
- Class 7 clean room production
- RNase/DNase and Pyrogen free

Additional options

- Sterilization using gamma irradiation or Eto treatment
- Precapped with Screw Cap
- Customized tube codes and rack barcode

Specifications



	Working volume at +21°C is 6.00ml (Screw Cap)
	Flat bottom
	Highest purity Polypropylene
	Tube height is 48.0mm / Tube height in rack is 49.0mm (see page 57 for dim. drawing)
	Resistant to Chemical solvents
	Vapor phase LN2 to +100°C

Ordering information

More information about product numbers and ordering, see page 45.



VIEW PRODUCT ONLINE

We offer two special storage solutions. First, an economical, Non-coded solution for storing up to 8 samples in a linked row (1.40ml). The Tubestrip-8 have the same features and benefits as other Micronic tubes. Second, we offer amber tinted polypropylene storage tubes. The Amber Tubes ensure the integrity of light sensitive biological samples.



Superior features

Tubestrip-8

- Standard available Non-coded
- Class 7 clean room production
- RNase/DNase and Pyrogen free
- Additional options: sterilization using gamma irradiation or Eto treatment, snap tubestrips
- Low cost solution for storing up to 8 samples in a linked row

Amber tubes

- For light sensitive samples
- Available Non-coded or with unique laser etched 2D Data-Matrix code which adheres to the ECC200 standard on the tube bottom
- 2D codes also have a human-readable code
- Black code surface cannot be separated from the transparent tube due to the unique 2K injection molding technique
- Available in 96-2 and 96-4 ULT Racks (DM) which are based on the ANSI / SLAS standards for storage racks
- Class 7 clean room production
- RNase/DNase and Pyrogen free
- Additional options: sterilization using gamma irradiation or Eto treatment, snap tubes, precapped, customized 2D Data-Matrix code and 1D rack barcode

Specifications

		Working volume at +21°C is 1.20ml
		U-bottom
		Highest purity Polypropylene
		Tube height is 45.4mm / Tube height with Push Cap rack is 46.4mm (EVA)
		Resistant to Chemical solvents
		-80°C to +100°C

**For specification of the Amber tubes see page 13 (0.75ml) or page 15 (1.40ml)*

Ordering information

More information about product numbers and ordering, see page 45.



0.50ml storage tubes

from page 12

Catalog number	Description	Case Size
0.50ml Non coded Screw Cap tubes with Internal Thread V-bottom without caps		
MP32040	0.50ml Non coded Screw Cap tubes with Internal Thread in Bulk	5 x 960 tubes
MP32100	0.50ml Non coded Screw Cap tubes with Internal Thread in Micronic 96-1 Rack with low cover	4 x 10 racks
MP32101	0.50ml Non coded Screw Cap tubes with Internal Thread in Micronic 96-Q1 Rack with high cover	4 x 10 racks
MP32102	0.50ml Non coded Screw Cap tubes with Internal Thread in Micronic 96-1-DM Rack with low cover	4 x 10 racks
MP32103	0.50ml Non coded Screw Cap tubes with Internal Thread in Micronic 96-Q1-DM Rack with high cover	4 x 10 racks
0.50ml Alphanumeric coded Screw Cap tubes with Internal Thread V-bottom without caps		
MP42100	0.50ml Alphanumeric coded Screw Cap tubes with Internal Thread in Micronic 96-1 Rack with low cover	4 x 10 racks
MP42101	0.50ml Alphanumeric coded Screw Cap tubes with Internal Thread in Micronic 96-Q1 Rack with high cover	4 x 10 racks
MP42102	0.50ml Alphanumeric coded Screw Cap tubes with Internal Thread in Micronic 96-1-DM Rack with low cover	4 x 10 racks
MP42103	0.50ml Alphanumeric coded Screw Cap tubes with Internal Thread in Micronic 96-Q1-DM Rack with high cover	4 x 10 racks
0.50ml 2D Data-Matrix coded Screw Cap tubes with Internal Thread V-bottom without caps		
MP52326	0.50ml 2D Data-Matrix coded Screw Cap tubes with Internal Thread in Bulk	5 x 960 tubes
MP52500	0.50ml 2D Data-Matrix coded Screw Cap tubes with Internal Thread in Micronic 96-1 Rack with low cover	4 x 10 racks
MP52501	0.50ml 2D Data-Matrix coded Screw Cap tubes with Internal Thread in Micronic 96-Q1 Rack with high cover	4 x 10 racks
MP52502	0.50ml 2D Data-Matrix coded Screw Cap tubes with Internal Thread in Micronic 96-1-DM Rack with low cover	4 x 10 racks
MP52503	0.50ml 2D Data-Matrix coded Screw Cap tubes with Internal Thread in Micronic 96-Q1-DM Rack with high cover	4 x 10 racks

Also available precapped with (Low Profile) Screw Cap or Push Cap.

0.75ml storage tubes

from page 13

Catalog number	Description	Case Size
0.75ml Non coded Screw Cap tubes with Internal Thread V-bottom without caps		
MP32069	0.75ml Non coded Screw Cap tubes with Internal Thread in Bulk	5 x 960 tubes
MP32070	0.75ml Non coded Screw Cap tubes with Internal Thread in refill carrier-96	5 x 10 refills
MP32110	0.75ml Non coded Screw Cap tubes with Internal Thread in Micronic 96-2 Rack with low cover	4 x 10 racks
MP32111	0.75ml Non coded Screw Cap tubes with Internal Thread in Micronic 96-2 Rack with high cover	4 x 10 racks
MP32114	0.75ml Non coded Screw Cap tubes with Internal Thread in Micronic 96-2-DM Rack with low cover	4 x 10 racks
MP32115	0.75ml Non coded Screw Cap tubes with Internal Thread in Micronic 96-2-DM Rack with high cover	4 x 10 racks
0.75ml Alphanumeric coded Screw Cap tubes with Internal Thread V-bottom without caps		
MP42067	0.75ml Alphanumeric coded Screw Cap tubes with Internal Thread in refill carrier-96	5 x 10 refills
MP42110	0.75ml Alphanumeric coded Screw Cap tubes with Internal Thread in Micronic 96-2 Rack with low cover	4 x 10 racks
MP42111	0.75ml Alphanumeric coded Screw Cap tubes with Internal Thread in Micronic 96-2 Rack with high cover	4 x 10 racks
MP42114	0.75ml Alphanumeric coded Screw Cap tubes with Internal Thread in Micronic 96-2-DM Rack with low cover	4 x 10 racks
MP42115	0.75ml Alphanumeric coded Screw Cap tubes with Internal Thread in Micronic 96-2-DM Rack with high cover	4 x 10 racks
0.75ml 2D Data-Matrix coded Screw Cap tubes with Internal Thread V-bottom without caps		
MP52349	0.75ml 2D Data-Matrix coded Screw Cap tubes with Internal Thread in Bulk	5 x 960 tubes
MP52350	0.75ml 2D Data-Matrix coded Screw Cap tubes with Internal Thread in refill carrier-96	5 x 10 refills
MP52519	0.75ml 2D Data-Matrix coded Screw Cap tubes with Internal Thread in Micronic 96-2 Rack with low cover	4 x 10 racks
MP52520	0.75ml 2D Data-Matrix coded Screw Cap tubes with Internal Thread in Micronic 96-2 Rack with high cover	4 x 10 racks
MP52521	0.75ml 2D Data-Matrix coded Screw Cap tubes with Internal Thread in Micronic 96-2-DM Rack with low cover	4 x 10 racks
MP52522	0.75ml 2D Data-Matrix coded Screw Cap tubes with Internal Thread in Micronic 96-2-DM Rack with high cover	4 x 10 racks
MP52525	0.75ml 2D Data-Matrix coded Screw Cap tubes with Internal Thread in Micronic 138-2 HD Rack without cover	4 x 10 racks

Other item numbers are available for 0.75ml Push Cap tubes V- or U-bottom. Also available precapped with (Low Profile) Screw Cap or Push Cap.

1.10ml storage tubes

from page 14

Catalog number	Description	Case Size
1.10ml Non coded Screw Cap tubes with Internal Thread V-bottom without caps		
MP32033	1.10ml Non coded Screw Cap tubes with Internal Thread in Bulk	4 x 960 tubes
MP32033L	1.10ml Non coded Screw Cap tubes with Internal Thread Snap in Bulk	4 x 960 tubes
MP32120	1.10ml Non coded Screw Cap tubes with Internal Thread in Micronic 96-3 Rack with low cover	4 x 10 racks
MP32121	1.10ml Non coded Screw Cap tubes with Internal Thread in Micronic 96-3 Rack with high cover	4 x 10 racks
MP32122	1.10ml Non coded Screw Cap tubes with Internal Thread in Micronic 96-3-DM Rack with low cover	4 x 10 racks
MP32123	1.10ml Non coded Screw Cap tubes with Internal Thread in Micronic 96-3-DM Rack with high cover	4 x 10 racks
1.10ml 2D Data-Matrix coded Screw Cap tubes with Internal Thread V-bottom without caps		
MP52318	1.10ml 2D Data-Matrix coded Screw Cap tubes with Internal Thread in Bulk	4 x 960 tubes
MP52318L	1.10ml 2D Data-Matrix coded Screw Cap tubes with Internal Thread Snap in Bulk	4 x 960 tubes
MP52540	1.10ml 2D Data-Matrix coded Screw Cap tubes with Internal Thread in Micronic 96-3 Rack with low cover	4 x 10 racks
MP52541	1.10ml 2D Data-Matrix coded Screw Cap tubes with Internal Thread in Micronic 96-3 Rack with high cover	4 x 10 racks
MP52542	1.10ml 2D Data-Matrix coded Screw Cap tubes with Internal Thread in Micronic 96-3-DM Rack with low cover	4 x 10 racks
MP52543	1.10ml 2D Data-Matrix coded Screw Cap tubes with Internal Thread in Micronic 96-3-DM Rack with high cover	4 x 10 racks

Also available precapped with (Low Profile) Screw Cap or Push Cap.

1.40ml storage tubes

from page 15

Catalog number	Description	Case Size
1.40ml Standard Push Cap tubes U-bottom without caps (round bottom)		
MP32022	1.40ml Non coded Push Cap tubes in Bulk	4 x 960 tubes
MP32134	1.40ml Non coded Push Cap tubes (standard) in Micronic 96-4 Rack with low cover	4 x 10 racks
MP32141	1.40ml Non coded Push Cap tubes (standard) in Micronic 96-4-DM Rack with low cover	4 x 10 racks
MP22502	1.40ml Non coded Push Cap tubes in Comorack-96 (polycarbonate)	4 x 10 racks
1.40ml Non coded Screw Cap tubes with Internal Thread V-bottom without caps		
MP32074	1.40ml Non coded Screw Cap tubes with Internal Thread in Bulk	4 x 960 tubes
MP32130	1.40ml Non coded Screw Cap tubes with Internal Thread in Micronic 96-4 Rack with low cover	4 x 10 racks
MP32131	1.40ml Non coded Screw Cap tubes with Internal Thread in Micronic 96-4 Rack with high cover	2 x 10 racks
MP32137	1.40ml Non coded Screw Cap tubes with Internal Thread in Micronic 96-4-DM Rack with low cover	4 x 10 racks
MP32138	1.40ml Non coded Screw Cap tubes with Internal Thread in Micronic 96-4-DM Rack with high cover	2 x 10 racks
1.40ml Alphanumeric coded Screw Cap tubes with Internal Thread V-bottom without caps		
MP42070	1.40ml Alphanumeric coded Screw Cap tubes with Internal Thread in refill carrier-96	5 x 10 refills
MP42130	1.40ml Alphanumeric coded Screw Cap tubes with Internal Thread in Micronic 96-4 Rack with low cover	4 x 10 racks
MP42131	1.40ml Alphanumeric coded Screw Cap tubes with Internal Thread in Micronic 96-4 Rack with high cover	2 x 10 racks
MP42137	1.40ml Alphanumeric coded Screw Cap tubes with Internal Thread in Micronic 96-4-DM Rack with low cover	4 x 10 racks
MP42138	1.40ml Alphanumeric coded Screw Cap tubes with Internal Thread in Micronic 96-4-DM Rack with high cover	2 x 10 racks
1.40ml 2D Data-Matrix coded Screw Cap tubes with Internal Thread V-bottom without caps		
MP52353	1.40ml 2D Data-Matrix coded Screw Cap tubes with Internal Thread in Bulk	4 x 960 tubes
MP52550	1.40ml 2D Data-Matrix coded Screw Cap tubes with Internal Thread in Micronic 96-4 Rack with low cover	4 x 10 racks
MP52551	1.40ml 2D Data-Matrix coded Screw Cap tubes with Internal Thread in Micronic 96-4 Rack with high cover	2 x 10 racks
MP52556	1.40ml 2D Data-Matrix coded Screw Cap tubes with Internal Thread in Micronic 96-4-DM Rack with low cover	4 x 10 racks
MP52557	1.40ml 2D Data-Matrix coded Screw Cap tubes with Internal Thread in Micronic 96-4-DM Rack with high cover	2 x 10 racks

Other item numbers are available for 1.40ml Push Cap tubes V- or U-bottom or 1.40ml Screw Cap Tubes U-bottom. Also available precapped with (Low Profile) Screw Cap or Push Cap.

2.00ml storage tubes

from page 16

Catalog number	Description	Case Size
2.00ml Screw Cap tubes with Internal Thread U-bottom without caps		
MP42150	2.00ml Alphanumeric coded Screw Cap tubes with Internal Thread in Micronic 96-5 Rack with low cover	4 x 6 racks
MP42151	2.00ml Alphanumeric coded Screw Cap tubes with Internal Thread in Micronic 96-5 Rack with high cover	4 x 6 racks
MP52359	2.00ml 2D Data-Matrix coded Screw Cap tubes with Internal Thread in Bulk	4 x 576 tubes
MP52570	2.00ml 2D Data-Matrix coded Screw Cap tubes with Internal Thread in Micronic 96-5 Rack with low cover	4 x 6 racks
MP52571	2.00ml 2D Data-Matrix coded Screw Cap tubes with Internal Thread in Micronic 96-5 Rack with high cover	4 x 6 racks

Also available precapped with (Low Profile) Screw Cap or Push Cap.

4.00ml storage tubes

from page 17

Catalog number	Description	Case Size
4.00ml Screw Cap tubes with Internal Thread without caps		
MP32200	4.00ml Non coded Screw Cap tubes with Internal Thread Bulk	4 x 480 tubes
MP32201	4.00ml Non coded Screw Cap tubes with Internal Thread in Micronic 48-4 Rack with high cover	2 x 10 racks
MP42200	4.00ml Alphanumeric coded Screw Cap tubes with Internal Thread in Micronic 48-4 Rack with high cover	2 x 10 racks
MP52440	4.00ml 2D Data-Matrix coded Screw Cap tubes with Internal Thread in Bulk	4 x 480 tubes
MP52441	4.00ml 2D Data-Matrix coded Screw Cap tubes with Internal Thread in Micronic 48-4 Rack with high cover	2 x 10 racks

Also available precapped with Screw Cap

6.00ml storage tubes

from page 18

Catalog number	Description	Case Size
6.00ml Screw Cap tubes with Internal Thread without caps		
MP32300	6.00ml Non coded Screw Cap tubes with Internal Thread Bulk	4 x 240 tubes
MP32301	6.00ml Non coded Screw Cap tubes with Internal Thread in Micronic 24-4 Rack with high cover	2 x 10 racks
MP52400	6.00ml 2D Data-Matrix coded Screw Cap tubes with Internal Thread in Bulk	4 x 240 tubes
MP52410	6.00ml 2D Data-Matrix coded Screw Cap tubes with Internal Thread in Micronic 24-4 Rack with high cover	2 x 10 racks

Also available precapped with Screw Cap

1.40ml storage tubes hybrid

from page 19

Catalog number	Description	Case Size
1.40ml Screw Cap tubes with Internal Thread Hybrid V-bottom without caps		
MP52360	1.40ml 2D Data-Matrix coded Screw Cap tubes with Int. Thread Hybrid W1D Bulk	4 x 960 tubes
MP52361	1.40ml 2D Data-Matrix coded Screw Cap tubes with Int. Thread Hybrid W00 Bulk	4 x 960 tubes
MP52580	1.40ml 2D Data-Matrix coded Screw Cap tubes with Int. Thread Hybrid W1D in Micronic 96-4 Rack with low cover	4 x 10 racks
MP52581	1.40ml 2D Data-Matrix coded Screw Cap tubes with Int. Thread Hybrid W00 in Micronic 96-4 Rack with low cover	4 x 10 racks
MP52582	1.40ml 2D Data-Matrix coded Screw Cap tubes with Int. Thread Hybrid W1D in Micronic 96-4 Rack with high cover	2 x 10 racks
MP52583	1.40ml 2D Data-Matrix coded Screw Cap tubes with Int. Thread Hybrid W00 in Micronic 96-4 Rack with high cover	2 x 10 racks
MP52584	1.40ml 2D Data-Matrix coded Screw Cap tubes with Int. Thread Hybrid W1D in Micronic 96-4-DM Rack with low cover	4 x 10 racks
MP52585	1.40ml 2D Data-Matrix coded Screw Cap tubes with Int. Thread Hybrid W00 in Micronic 96-4-DM Rack with low cover	4 x 10 racks
MP52586	1.40ml 2D Data Matrix coded Screw Cap tubes with Int. Thread Hybrid W1D in Micronic 96-4-DM Rack with high cover	2 x 10 racks
MP52587	1.40ml 2D Data-Matrix coded Screw Cap tubes with Int. Thread Hybrid W00 in Micronic 96-4-DM Rack with high cover	2 x 10 racks

1.40ml storage tubes hybrid

from page 19

Catalog number	Description	Case Size
1.40ml Screw Cap tubes with Internal Thread Hybrid V-bottom precapped with Grey Screw Cap		
MP52360-Z20	1.40ml 2D Data-Matrix coded Screw Cap tubes with Int. Thread precapped with Grey Screw Cap Hybrid W1D Bulk	4 x 960 tubes
MP52361-Z20	1.40ml 2D Data-Matrix coded Screw Cap tubes with Int. Thread precapped with Grey Screw Cap Hybrid W00 Bulk	4 x 960 tubes
MP52582-Z20	1.40ml 2D Data-Matrix coded Screw Cap tubes with Int. Thread precapped with Grey Screw Cap Hybrid W1D in Micronic 96-4 Rack with high cover	2 x 10 racks
MP52583-Z20	1.40ml 2D Data-Matrix coded Screw Cap tubes with Int. Thread precapped with Grey Screw Cap Hybrid W00 in Micronic 96-4 Rack with high cover	2 x 10 racks
MP52586-Z20	1.40ml 2D Data Matrix coded Screw Cap tubes with Int. Thread precapped with Grey Screw Cap Hybrid W1D in Micronic 96-4-DM Rack with high cover	2 x 10 racks
MP52587-Z20	1.40ml 2D Data-Matrix coded Screw Cap tubes with Int. Thread precapped with Grey Screw Cap Hybrid W00 in Micronic 96-4-DM Rack with high cover	2 x 10 racks

Also available precapped with Low Profile Screw Cap or Push Cap.

0.30ml storage tubes

from page 20

Catalog number	Description	Case Size
0.30ml Non coded Screw Cap tubes with External Thread V-bottom without caps		
MP32146	0.30ml Non coded Screw Cap tubes with External Thread Bulk	5 x 960 tubes
MP32147	0.30ml Non coded Screw Cap tubes with External Thread in Micronic 96-1 Rack with low cover	4 x 10 racks
MP32148	0.30ml Non coded Screw Cap tubes with External Thread in Micronic 96-1-DM Rack with low cover	4 x 10 racks
0.30ml 2D Data-Matrix coded Screw Cap tubes with External Thread V-bottom without caps		
MP52701	0.30ml 2D Data-Matrix coded Screw Cap tubes with External Thread Bulk	5 x 960 tubes
MP52703	0.30ml 2D Data-Matrix coded Screw Cap tubes with External Thread in Micronic 96-1 Rack with low cover	4 x 10 racks
MP52736	0.30ml 2D Data-Matrix coded Screw Cap tubes with External Thread in Micronic 96-1-DM Rack with low cover	4 x 10 racks
0.30ml 2D Data-Matrix coded Screw Cap tubes with External Thread Vr-bottom precapped with Grey Screw Cap IG		
MP52700-G71	0.30ml 2D Data-Matrix coded Screw Cap tubes with External Thread precapped with Grey Screw Cap IG Bulk	5 x 960 tubes
MP52702-G71	0.30ml 2D Data-Matrix coded Screw Cap tubes with External Thread precapped with Grey Screw Cap IG in Micronic 96-1 Rack with low cover	4 x 10 racks
MP52735-G71	0.30ml 2D Data-Matrix coded Screw Cap tubes with External Thread precapped with Grey Screw Cap IG in Micronic 96-1-DM Rack with low cover	4 x 10 racks

Also available precapped with Screw Cap or Push Cap.

0.40ml storage tubes

from page 21

Catalog number	Description	Case Size
0.40ml Screw Cap tubes with External Thread V-bottom without caps		
MP52716	0.40ml 2D Data-Matrix coded Screw Cap tubes with External Thread Bulk	5 x 960 tubes
MP52718	0.40ml 2D Data-Matrix coded Screw Cap tubes with External Thread in Micronic 96-1 Rack with high cover	4 x 10 racks
MP52737	0.40ml 2D Data-Matrix coded Screw Cap tubes with External Thread in Micronic 96-1-DM Rack with high cover	4 x 10 racks
0.40ml Screw Cap tubes with External Thread V-bottom precapped with Grey Screw Cap IG		
MP52716-G71	0.40ml 2D Data-Matrix coded Screw Cap tubes with External Thread precapped with Grey Screw Cap IG Bulk	5 x 960 tubes
MP52718-G71	0.40ml 2D Data-Matrix coded Screw Cap tubes with External Thread precapped with Grey Screw Cap IG in Micronic 96-1 Rack with high cover	4 x 10 racks
MP52737-G71	0.40ml 2D Data-Matrix coded Screw Cap tubes with External Thread precapped with Grey Screw Cap IG in Micronic 96-1-DM Rack with high cover	4 x 10 racks

Also available precapped with Screw Cap or Push Cap.

0.75ml storage tubes

from page 22

Catalog number	Description	Case Size
0.75ml Non coded Screw Cap tubes with External Thread V-bottom without caps		
MP32150	0.75ml Non coded Screw Cap tubes with External Thread Bulk	5 x 960 tubes
MP32151	0.75ml Non coded Screw Cap tubes with External Thread in Micronic 96-2 Rack with high cover	4 x 10 racks
MP32154	0.75ml Non coded Screw Cap tubes with External Thread in Micronic 96-2-DM Rack with high cover	4 x 10 racks
0.75ml 2D Data-Matrix coded Screw Cap tubes with External Thread V-bottom without caps		
MP52704	0.75ml 2D Data-Matrix coded Screw Cap tubes with External Thread Bulk	4 x 960 tubes
MP52706	0.75ml 2D Data-Matrix coded Screw Cap tubes with External Thread in Micronic 96-2 Rack with high cover	4 x 10 racks
MP52738	0.75ml 2D Data-Matrix coded Screw Cap tubes with External Thread in Micronic 96-2-DM Rack with high cover	4 x 10 racks
MP52727	0.75ml 2D Data-Matrix coded Screw Cap tubes with External Thread in Micronic 138-2 HD Rack without cover	4 x 10 racks

Also available precapped with Screw Cap (IG) or Push Cap.

0.80ml storage tubes

from page 23

Catalog number	Description	Case Size
0.80ml Screw Cap tubes with External Thread V-bottom without caps		
MP52720	0.80ml 2D Data-Matrix coded Screw Cap tubes with External Thread Bulk	4 x 960 tubes
MP52722	0.80ml 2D Data-Matrix coded Screw Cap tubes with External Thread in Micronic 96-3 Rack with low cover	4 x 10 racks
MP52739	0.80ml 2D Data-Matrix coded Screw Cap tubes with External Thread in Micronic 96-3-DM Rack with low cover	4 x 10 racks
MP52728	0.80ml 2D Data-Matrix coded Screw Cap tubes with External Thread in Micronic 138-2 HD Rack without cover	4 x 10 racks
0.80ml Screw Cap tubes with External Thread V-bottom precapped with Screw Cap IG		
MP52720-G71	0.80ml 2D Data-Matrix coded Screw Cap tubes with External Thread precapped with Grey Screw Cap IG Bulk	4 x 960 tubes
MP52722-G71	0.80ml 2D Data-Matrix coded Screw Cap tubes with External Thread precapped with Grey Screw Cap IG in Micronic 96-3 Rack with low cover	4 x 10 racks
MP52739-G71	0.80ml 2D Data-Matrix coded Screw Cap tubes with External Thread precapped with Grey Screw Cap IG in Micronic 96-3-DM Rack with low cover	4 x 10 racks
MP52728-G71	0.80ml 2D Data-Matrix coded Screw Cap tubes with External Thread precapped with Grey Screw Cap IG in Micronic 138-2 HD Rack without cover	4 x 10 racks

Also available precapped with Screw Cap or Push Cap.

1.10ml storage tubes

from page 24

Catalog number	Description	Case Size
1.10ml 2D Data-Matrix coded Screw Cap tubes with External Thread V-bottom without caps		
MP52730	1.10ml 2D Data-Matrix coded Screw Cap tubes with External Thread Bulk	4 x 960 tubes
MP52732	1.10ml 2D Data-Matrix coded Screw Cap tubes with External Thread in Micronic 96-3 Rack with high cover	4 x 10 racks
MP52740	1.10ml 2D Data-Matrix coded Screw Cap tubes with External Thread in Micronic 96-3-DM Rack with high cover	4 x 10 racks
1.10ml 2D Data-Matrix coded Screw Cap tubes with External Thread V-bottom precapped with Screw Cap IG		
MP52730-G71	1.10ml 2D Data-Matrix coded Screw Cap tubes with External Thread precapped with Grey Screw Cap IG Bulk	4 x 960 tubes
MP52732-G71	1.10ml 2D Data-Matrix coded Screw Cap tubes with External Thread precapped with Grey Screw Cap IG in Micronic 96-3 Rack with high cover	4 x 10 racks
MP52740-G71	1.10ml 2D Data-Matrix coded Screw Cap tubes with External Thread precapped with Grey Screw Cap IG in Micronic 96-3-DM Rack with high cover	4 x 10 racks

Also available precapped with Screw Cap or Push Cap.

1.40ml storage tubes

from page 25

Catalog number	Description	Case Size
1.40ml Non coded Screw Cap tubes with External Thread V-bottom without caps		
MP32152	1.40ml Non coded Screw Cap tubes with External thread Bulk	4 x 960 tubes
MP32153	1.40ml Non coded Screw Cap tubes with External Thread in Micronic 96-4 Rack with high cover	2 x 10 racks
MP32155	1.40ml Non coded Screw Cap tubes with External Thread in Micronic 96-4-DM Rack with high cover	2 x 10 racks
1.40ml 2D Data-Matrix coded Screw Cap tubes with External Thread V-bottom without caps		
MP52708	1.40ml 2D Data-Matrix coded Screw Cap tubes with External Thread Bulk	4 x 960 tubes
MP52710	1.40ml 2D Data-Matrix coded Screw Cap tubes with External Thread in Micronic 96-4 Rack with high cover	2 x 10 racks
MP52741	1.40ml 2D Data-Matrix coded Screw Cap tubes with External Thread in Micronic 96-4-DM Rack with high cover	2 x 10 racks

Also available precapped with Screw Cap (IG) or Push Cap.

2.00ml storage tubes

from page 26

Catalog number	Description	Case Size
2.00ml Screw Cap tubes with External Thread V-bottom without caps		
MP52712	2.00ml 2D Data-Matrix coded Screw Cap tubes with External Thread Bulk	4 x 576 tubes
MP52714	2.00ml 2D Data-Matrix coded Screw Cap tubes with External Thread in Micronic 96-5 Rack with high cover	4 x 6 racks
2.00ml Screw Cap tubes with External Thread V-bottom standard precapped with Grey Screw Cap IG		
MP52712-G71	2.00ml 2D Data-Matrix coded Screw Cap tubes with External Thread precapped with Grey Screw Cap IG Bulk	4 x 576 tubes
MP52714-G71	2.00ml 2D Data-Matrix coded Screw Cap tubes with External Thread precapped with Grey Screw Cap IG in Micronic 96-5 Rack with high cover	4 x 6 racks

Also available precapped with Screw Cap or Push Cap.

1.00ml storage tubes

from page 27

Catalog number	Description	Case Size
1.00ml Screw Cap tubes with External Thread Flat bottom without caps		
MP52800	1.00ml 2D Data-Matrix coded Screw Cap tubes with External Thread Bulk	5 x 480 tubes
MP52802	1.00ml 2D Data-Matrix coded Screw Cap tubes with External Thread in Micronic 48-1 Rack with low cover	4 x 10 racks
1.00ml Screw Cap tubes with External Thread Flat bottom standard precapped with Grey Screw Caps		
MP52800-Y20	1.00ml 2D Data-Matrix coded Screw Cap tubes with External Thread precapped with Grey Screw Cap Bulk	5 x 480 tubes
MP52802-Y20	1.00ml 2D Data-Matrix coded Screw Cap tubes with External Thread precapped with Grey Screw Cap in Micronic 48-1 Rack with low cover	4 x 10 racks

4.00ml storage tubes

from page 28

Catalog number	Description	Case Size
4.00ml Screw Cap tubes with External Thread Flat bottom without caps		
MP52808	4.00ml 2D Data-Matrix coded Screw Cap tubes with External Thread Bulk	4 x 480 tubes
MP52810	4.00ml 2D Data-Matrix coded Screw Cap tubes with External Thread in Micronic 48-4 Rack with high cover	2 x 10 racks
4.00ml Screw Cap tubes with External Thread Flat bottom standard precapped with Grey Screw Caps		
MP52808-Y20	4.00ml 2D Data-Matrix coded Screw Cap tubes with External Thread precapped with Grey Screw Cap Bulk	4 x 480 tubes
MP52810-Y20	4.00ml 2D Data-Matrix coded Screw Cap tubes with External Thread precapped with Grey Screw Cap in Micronic 48-4 Rack with high cover	2 x 10 racks

3.50ml storage tubes

from page 29

Catalog number	Description	Case Size
3.50ml Screw Cap tubes with External Thread Flat bottom without caps		
MP52904	3.50ml 2D Data-Matrix coded Screw Cap tubes with External Thread Bulk	4 x 240 tubes
MP52906	3.50ml 2D Data-Matrix coded Screw Cap tubes with External Thread in Micronic 24-2 Rack with high cover	4 x 10 racks
3.50ml Screw cap tubes with External Thread Flat bottom precapped with Grey Screw Caps		
MP52904-Y20	3.50ml 2D Data-Matrix coded Screw Cap tubes with External Thread precapped with Grey Screw Cap Bulk	4 x 240 tubes
MP52906-Y20	3.50ml 2D Data-Matrix coded Screw Cap tubes with External Thread precapped with Grey Screw Cap in Micronic 24-2 Rack with high cover	4 x 10 racks

0.75ml storage tubes hybrid

from page 30

Catalog number	Description	Case Size
0.75ml Screw Cap tubes with External Thread Hybrid V-bottom without caps		
MP52755	0.75ml 2D Data-Matrix coded Screw Cap tubes with Ext. Thread Hybrid W1D Bulk	4 x 960 tubes
MP52762	0.75ml 2D Data-Matrix coded Screw Cap tubes with Ext. Thread Hybrid W00 Bulk	4 x 960 tubes
MP52757	0.75ml 2D Data-Matrix coded Screw Cap tubes with Ext. Thread Hybrid W1D in Micronic 96-2 Rack with high cover	4 x 10 racks
MP52763	0.75ml 2D Data-Matrix coded Screw Cap tubes with Ext. Thread Hybrid W00 in Micronic 96-2 Rack with high cover	4 x 10 racks
MP52780	0.75ml 2D Data-Matrix coded Screw Cap tubes with Ext. Thread Hybrid W1D in Micronic 96-2-DM Rack with high cover	4 x 10 racks
MP52781	0.75ml 2D Data-Matrix coded Screw Cap tubes with Ext. Thread Hybrid W00 in Micronic 96-2-DM Rack with high cover	4 x 10 racks
MP52775	0.75ml 2D Data-Matrix coded Screw Cap tubes with Ext. Thread Hybrid W1D in Micronic 138-2 HD Rack without cover	4 x 10 racks
0.75ml Screw Cap tubes with External Thread Hybrid V-bottom precapped with Grey Screw Cap		
MP52755-Y20	0.75ml 2D Data-Matrix coded Screw Cap tubes with Ext. Thread Hybrid W1D precapped with Grey Screw Cap Bulk	4 x 960 tubes
MP52762-Y20	0.75ml 2D Data-Matrix coded Screw Cap tubes with Ext. Thread Hybrid W00 precapped with Grey Screw Cap Bulk	4 x 960 tubes
MP52757-Y20	0.75ml 2D Data-Matrix coded Screw Cap tubes with Ext. Thread Hybrid W1D precapped with Grey Screw Cap in Micronic 96-2 Rack with high cover	4 x 10 racks
MP52763-Y20	0.75ml 2D Data-Matrix coded Screw Cap tubes with Ext. Thread Hybrid W00 precapped with Grey Screw Cap in Micronic 96-2 Rack with high cover	4 x 10 racks
MP52780-Y20	0.75ml 2D Data-Matrix coded Screw Cap tubes with Ext. Thread Hybrid W1D precapped with Grey Screw Cap in Micronic 96-2-DM Rack with high cover	4 x 10 racks
MP52781-Y20	0.75ml 2D Data-Matrix coded Screw Cap tubes with Ext. Thread Hybrid W00 precapped with Grey Screw Cap in Micronic 96-2-DM Rack with high cover	4 x 10 racks
MP52775-Y20	0.75ml 2D Data-Matrix coded Screw Cap tubes with Ext. Thread Hybrid W1D precapped with Grey Screw Cap in Micronic 138-2 HD Rack without cover	4 x 10 racks

Also available precapped with Push Cap.

1.40ml storage tubes hybrid

from page 31

Catalog number	Description	Case Size
1.40ml Screw Cap tubes with External Thread Hybrid V-bottom without caps		
MP52759	1.40ml 2D Data-Matrix coded Screw Cap tubes with Ext. Thread Hybrid W1D Bulk	4 x 960 tubes
MP52764	1.40ml 2D Data-Matrix coded Screw Cap tubes with Ext. Thread Hybrid W00 Bulk	4 x 960 tubes
MP52761	1.40ml 2D Data-Matrix coded Screw Cap tubes with Ext. Thread Hybrid W1D in Micronic 96-4 Rack with high cover	2 x 10 racks
MP52765	1.40ml 2D Data-Matrix coded Screw Cap tubes with Ext. Thread Hybrid W00 in Micronic 96-4 Rack with high cover	2 x 10 racks
MP52782	1.40ml 2D Data-Matrix coded Screw Cap tubes with Ext. Thread Hybrid W1D in Micronic 96-4-DM Rack with high cover	2 x 10 racks
MP52783	1.40ml 2D Data-Matrix coded Screw Cap tubes with Ext. Thread Hybrid W00 in Micronic 96-4-DM Rack with high cover	2 x 10 racks

1.40ml storage tubes hybrid

from page 31

Catalog number	Description	Case Size
1.40ml Screw Cap tubes with External Thread Hybrid -bottom precapped with Grey Screw Cap		
MP52759-Y20	1.40ml 2D Data-Matrix coded Screw Cap tubes with Ext. Thread Hybrid W1D precapped with Grey Screw Cap Bulk	4 x 960 tubes
MP52764-Y20	1.40ml 2D Data-Matrix coded Screw Cap tubes with Ext. Thread Hybrid W00 precapped with Grey Screw Cap Bulk	4 x 960 tubes
MP52761-Y20	1.40ml 2D Data-Matrix coded Screw Cap tubes with Ext. Thread Hybrid W1D precapped with Grey Screw Cap in Micronic 96-4 Rack with high cover	2 x 10 racks
MP52765-Y20	1.40ml 2D Data-Matrix coded Screw Cap tubes with Ext. Thread Hybrid W00 precapped with Grey Screw Cap in Micronic 96-4 Rack with high cover	2 x 10 racks
MP52782-Y20	1.40ml 2D Data-Matrix coded Screw Cap tubes with Ext. Thread Hybrid W1D precapped with Grey Screw Cap in Micronic 96-4-DM Rack with high cover	2 x 10 racks
MP52783-Y20	1.40ml 2D Data-Matrix coded Screw Cap tubes with Ext. Thread Hybrid W00 precapped with Grey Screw Cap in Micronic 96-4-DM Rack with high cover	2 x 10 racks

Also available precapped with Push Cap.

2.00ml storage tubes hybrid

from page 32

Catalog number	Description	Case Size
2.00ml Screw Cap tubes with External Thread Hybrid Flat bottom without caps		
MP52855	2.00ml 2D Data-Matrix coded Screw Cap tubes with Ext. Thread Hybrid W1D Bulk	4 x 480 tubes
MP52856	2.00ml 2D Data-Matrix coded Screw Cap tubes with Ext. Thread Hybrid W00 Bulk	4 x 480 tubes
MP52858	2.00ml 2D Data-Matrix coded Screw Cap tubes with Ext. Thread Hybrid W1D in Micronic 48-2 Rack with high cover	4 x 10 racks
MP52859	2.00ml 2D Data-Matrix coded Screw Cap tubes with Ext. Thread Hybrid W00 in Micronic 48-2 Rack with high cover	4 x 10 racks

Also available precapped with Screw Cap.

3.00ml storage tubes hybrid

from page 33

Catalog number	Description	Case Size
3.00ml Screw Cap tubes with External Thread Hybrid Flat bottom without caps		
MP52861	3.00ml 2D Data-Matrix coded Screw Cap tubes with Ext. Thread Hybrid W1D Bulk	4 x 480 tubes
MP52862	3.00ml 2D Data-Matrix coded Screw Cap tubes with Ext. Thread Hybrid W00 Bulk	4 x 480 tubes
MP52864	3.00ml 2D Data-Matrix coded Screw Cap tubes with Ext. Thread Hybrid W1D in Micronic 48-3 Rack with high cover	4 x 10 racks
MP52865	3.00ml 2D Data-Matrix coded Screw Cap tubes with Ext. Thread Hybrid W00 in Micronic 48-3 Rack with high cover	4 x 10 racks

Also available precapped with Screw Cap.

1.50ml storage tubes hybrid

from page 34

Catalog number	Description	Case Size
1.50ml Screw Cap tubes with External Thread Hybrid Flat bottom without caps		
MP52951	1.50ml 2D Data-Matrix coded Screw Cap tubes with Ext. Thread Hybrid WHR Bulk	5 x 240 tubes
MP52952	1.50ml 2D Data-Matrix coded Screw Cap tubes with Ext. Thread Hybrid W00 Bulk	5 x 240 tubes
MP52954	1.50ml 2D Data-Matrix coded Screw Cap tubes with Ext. Thread Hybrid WHR in Micronic 24-1 Rack with low cover	4 x 10 racks
MP52955	1.50ml 2D Data-Matrix coded Screw Cap tubes with Ext. Thread Hybrid W00 in Micronic 24-1 Rack with low cover	4 x 10 racks

Also available precapped with Screw Cap

3.00ml storage tubes hybrid

from page 35

Catalog number	Description	Case Size
3.00ml Screw Cap tubes with External Thread Hybrid Flat bottom without caps		
MP52957	3.00ml 2D Data-Matrix coded Screw Cap tubes with Ext. Thread Hybrid WHR Bulk	4 x 240 tubes
MP52958	3.00ml 2D Data-Matrix coded Screw Cap tubes with Ext. Thread Hybrid W00 Bulk	4 x 240 tubes
MP52960	3.00ml 2D Data-Matrix coded Screw Cap tubes with Ext. Thread Hybrid WHR in Micronic 24-1 Rack with high cover	4 x 10 racks
MP52961	3.00ml 2D Data-Matrix coded Screw Cap tubes with Ext. Thread Hybrid W00 in Micronic 24-1 Rack with high cover	4 x 10 racks

Also available precapped with Screw Cap

6.00ml storage tubes hybrid

from page 36

Catalog number	Description	Case Size
6.00ml Screw Cap tubes with External Thread Hybrid Flat bottom without caps		
MP52963	6.00ml 2D Data-Matrix coded Screw Cap tubes with Ext. Thread Hybrid W1D Bulk	4 x 240 tubes
MP52964	6.00ml 2D Data-Matrix coded Screw Cap tubes with Ext. Thread Hybrid W00 Bulk	4 x 240 tubes
MP52966	6.00ml 2D Data-Matrix coded Screw Cap tubes with Ext. Thread Hybrid W1D in Micronic 24-4 Rack with high cover	2 x 10 racks
MP52967	6.00ml 2D Data-matrix coded Screw Cap tubes with Ext. Thread Hybrid W00 in Micronic 24-4 Rack with high cover	2 x 10 racks

Also available precapped with Screw Cap

SPECIAL tubes

from page 37

Catalog number	Description	Case Size
1.40ml Non coded Push Cap Tubestrip U-bottom		
MP32067	1.40ml Non coded Push Cap tubes in strip of 8-tubes	4 x 120 strips
MP32067L	1.40ml Non coded Push Cap tubes in strip of 8-tubes Snap	4 x 120 strips
Products for Light Sensitive Samples		
MP32087	0.75ml Non coded Screw Cap tubes with Internal Thread Amber V-bottom Bulk	5 x 960 tubes
MP32091	0.75ml Non coded Screw Cap tubes iwth Internal Thread Amber V-bottom in Micronic 96-2 Rack with high cover	4 x 10 racks
MP52561	1.40ml 2D Data-Matrix coded Screw Cap tubes with Internal Thread Amber V-bottom in Micronic 96-4 Rack with high cover	2 x 10 racks



Serving
scientists
since 1984

Certified
Class 7 clean
room manu-
facturing

SAMPLE STORAGE RACKS

All Micronic storage racks are based on the global recognized ANSI / SLAS 1-2004 through ANSI / SLAS 4-2004 Standards (formerly recognized as the ANSI / SBS Standards) and provide an easy and automation friendly method to store your sample storage tubes. For each sample storage tube format Micronic offers a robust and user friendly storage rack. The racks feature a laser etched 1D rack barcode on one side of the rack and for specific racks an additional 2D Data-Matrix code on the bottom. Furthermore, it features a "Twist-Lock" to prevent tubes from turning during screw (de)capping. Besides the standard barcoded racks, Micronic also offers the service to supply laser-etched 1D barcodes in customized formats.



Superior features of Micronic Sample Storage Racks

The racks have proven to be compatible for use in low temperature automated storage systems

Highly transparent cover enables easy visual checking of the enclosed samples

Novel cover lock system for cryogenic storage: "icebreaker" mechanism

Made from sturdy Polycarbonate which has excellent properties for low temperature storage (vapor phase LN₂)

Extremely strong design which minimizes deformation due to temperature changes

Highly visible laser-etched Alphanumeric coding on top of the rack

Rack orientation mark

Comes standard with laser-etched 1D barcode on the A1-H1 side (type 128B) and for specific rack types with an additional 2D code on the rack bottom

RNase / DNase and pyrogen free

Unique cover print indicating rack and tube type

Additional options



Twist-lock: Notches in well bottom prevent tubes from turning during screw-capping.



Snap-lock: Tubes are locked into the rack wells to prevent sample loss from overturned racks.









Rack bottom ID: Additional 2D Data-Matrix code on the bottom of the rack.

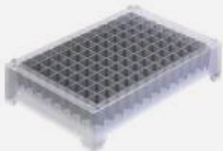

Customization options: Micronic offers the service to supply laser-etched 1D barcodes and 2D Data-Matrix codes in customized formats.







	COMORACK-96	MICRONIC 96-1	MICRONIC 96-Q1
	 	 	 
Rack material	PC	PC	PC
Quantity of tubes in rack	96	96	96
Available for tube volumes (nominal)	1.40ml (standard tube) (internal thread)	0.30ml, 0.40ml and 0.50ml (internal/external thread)	0.50ml (internal thread)
Rack height without cover	31.1mm	12.0mm	16.0mm
Tube height in rack without cover	<i>Standard tube</i>	<i>Internal Thread</i>	<i>Internal Thread</i>
(*Tubes with Push Caps and tubes with Low Profile Screw Caps are identical in height)	46.5mm (1.40ml without cap) 47.5mm (1.40ml with Push Cap)	19.5mm (0.50ml without cap) 20.5mm (0.50ml with Push Cap*) 26.5mm (0.50ml with Screw Cap) <i>External Thread</i> 17.4mm (0.30ml without cap) 18.8mm (0.30ml with Push Cap) 19.6mm (0.30ml with Screw Cap IG) 20.8mm (0.30ml with Screw Cap) 22.8mm (0.40ml without cap) 24.2mm (0.40ml with Push Cap) 25.0mm (0.40ml with Screw Cap IG) 26.3mm (0.40ml with Screw Cap)	19.5mm (without cap) 20.5mm (with Push Cap*) 27.2mm (with Screw Cap)
Rack height with low cover	n/a	23.8mm	30.8mm
Rack height with standard cover	52.0mm	n/a	n/a
Rack height with high cover	n/a	30.8mm	n/a
Available with 1D barcode on rack side	Yes (with label)	Yes (laser-etched)	Yes (laser-etched)
Available with 2D code on rack bottom	No	Yes	Yes
Twist-lock	No	Yes	Yes
Sterilization option	Yes	Yes	Yes
DNase / RNase free	Yes	Yes	Yes
Autoclavable**	No	No	No
Class 7 clean room production	Yes	Yes	Yes
Temperature range***	-80°C to + 140°C	Vapor phase LN2 to + 140°C	Vapor phase LN2 to + 140°C
Chemical resistance	+	++/+	++/+



** The racks can be autoclaved in +121°C. Please request more information about the number of cycles per rack type.

*** Temperature range of the material of the tubes, caps and racks is approved from -80°C to +100°C. In practice racks are used in higher temperatures for autoclaving (+121°C) and in lower temperatures until vapor phase LN2 (-150°C to -196°C) for storage. Micronic does not recommend to store racks in liquid phase nitrogen (LN2).

OVERVIEW AND SPECIFICATIONS

SAMPLE STORAGE RACKS

MICRONIC 96-2	MICRONIC 96-3	MICRONIC 96-4	MICRONIC 96-5	MICRONIC 138-2
 Page 52	 Page 52	 Page 52	 Page 52	 Page 58
PC 96 0.75ml (internal/external thread (hybrid))	PC 96 0.80ml and 1.10ml (internal/external thread)	PC 96 1.40ml (internal/external thread (hybrid))	PC 96 2.00ml (internal/external thread)	PC 138 0.75ml and 0.80ml (internal/external thread (hybrid))
19.0mm <i>Internal Thread</i> 27.0mm (without cap) 28.0mm (with Push Cap*) 34.7mm (with Screw Cap) <i>External Thread</i> 31.0mm (without cap) 32.4mm (with Push Cap) 33.3mm (with Screw Cap IG) 34.5mm (with Screw Cap)	22.7mm <i>Internal Thread</i> 37.5mm (1.10ml without cap) 38.5mm (with Push Cap*) 45.0mm (with Screw Cap) <i>External Thread</i> 35.8mm (0.80ml without cap) 37.2mm (with Push Cap) 38.0mm (with Screw Cap IG) 39.3mm (with Screw Cap) 42.3mm (1.10ml without cap) 43.7mm (with Push Cap) 44.6mm (with Screw Cap IG) 45.8mm (with Screw Cap)	30.0mm <i>Internal Thread</i> 45.0mm (without cap) 46.0mm (with Push Cap*) 53.0mm (with Screw Cap) <i>External Thread</i> 49.0mm (without cap) 50.4mm (with Push Cap) 51.3mm (with Screw Cap IG) 52.5mm (with Screw Cap)	41.0mm <i>Internal Thread</i> 60.0mm (without cap) 61.0mm (with Push Cap*) 67.5mm (with Screw Cap) <i>External Thread</i> 64.0mm (without cap) 65.4mm (with Push Cap) 66.3mm (with Screw Cap IG) 67.5mm (with Screw Cap)	20.2mm <i>Internal Thread</i> 27.0mm (0.75ml without cap) 28.0mm (with Push Cap*) 34.5mm (with Screw Cap) <i>External Thread</i> 31.0mm (0.75ml without cap) 32.4mm (with Push Cap) 33.3mm (with Screw Cap IG) 34.5mm (with Screw Cap) 35.8mm (0.80ml without cap) 37.2mm (with Push Cap) 38.1mm (with Screw Cap IG) 39.3mm (with Screw Cap)
30.8mm n/a 37.8mm	41.5mm n/a 48.5mm	48.8mm n/a 55.8mm	66.8mm n/a 74.3mm	n/a n/a n/a
Yes (laser-etched) Yes Yes Yes Yes No Yes	Yes (laser-etched) Yes Yes Yes Yes No Yes	Yes (laser-etched) Yes Yes Yes Yes No Yes	Yes (laser-etched) No Yes Yes Yes No Yes	Yes (laser-etched) No Yes Yes Yes No Yes
Vapor phase LN2 to + 140°C ++/+	Vapor phase LN2 to + 140°C ++/+	Vapor phase LN2 to + 140°C ++/+	Vapor phase LN2 to + 140°C ++/+	Vapor phase LN2 to + 140°C ++/+





	MICRONIC 48-1	MICRONIC 48-2	MICRONIC 48-3
	 Page 54	 Page 54	 Page 54
Rack material	PC	PC	PC
Quantity of tubes in rack	48	48	48
Available for tube volumes (nominal)	1.00ml (external thread)	2.00ml (external thread hybrid)	3.00ml (external thread hybrid)
Rack height without cover	12.0mm	19.0mm	22.7mm
Tube height in rack without cover	<i>External Thread</i> 17.0mm (without cap) 20.7mm (with Screw Cap)	<i>External Thread</i> 31.0mm (without cap) 34.5mm (with Screw Cap)	<i>External Thread</i> 42.0mm (without cap) 45.5mm (with Screw Cap)
Rack height with low cover	23.8mm	n/a	n/a
Rack height with high cover	n/a	30.8mm	41.5mm
Available with 1D barcode on rack side	Yes (laser-etched)	Yes (laser-etched)	Yes (laser-etched)
Available with 2D code on rack bottom	No	No	No
Twist-lock	Yes	Yes	Yes
Sterilization option	Yes	Yes	Yes
DNase / RNase free	Yes	Yes	Yes
Autoclavable*	No	No	No
Class 7 clean room production	Yes	Yes	Yes
Temperature range**	Vapor phase LN2 to + 140°C	Vapor phase LN2 to + 140°C	Vapor phase LN2 to + 140°C
Chemical resistance	++/+	++/+	++/+

* The racks can be autoclaved in +121°C. Please request more information about the number of cycles per rack type.

** Temperature range of the material of the tubes, caps and racks is approved from -80°C to +100°C. In practice racks are used in higher temperatures for autoclaving (+121°C) and in lower temperatures until vapor phase LN2 (-150°C to -196°C) for storage. Micronic does not recommend to store racks in liquid phase nitrogen (LN2).

OVERVIEW AND SPECIFICATIONS

SAMPLE STORAGE RACKS

MICRONIC 48-4	MICRONIC 24-1	MICRONIC 24-2	MICRONIC 24-4
 Page 54	 Page 56	 Page 56	 Page 56
PC 48 4.00ml (internal/external thread)	PC 24 1.50ml and 3.00ml (external thread hybrid)	PC 24 3.50ml (external thread hybrid)	PC 24 6.00ml (internal/external thread hybrid)
30.0mm <i>Internal Thread</i> 45.0mm (without cap) 52.4mm (with Screw Cap) <i>External Thread</i> 49.0mm (without cap) 52.5mm (with Screw Cap)	12.0mm <i>External Thread</i> 17.0mm (1.50ml without cap) 20.5mm (1.50ml with Screw Cap) 24.0mm (3.00ml without cap) 27.5mm (3.00ml with Screw Cap)	19.0mm <i>External Thread</i> 31.2mm (without cap) 34.7mm (with Screw Cap)	30.0mm <i>Internal Thread</i> 44.0mm (without cap) 51.9mm (with Screw Cap) <i>External Thread</i> 49.0mm (without cap) 52.5mm (with Screw Cap)
n/a 55.8mm	23.8mm 30.8mm	n/a 37.8mm	n/a 55.8mm
Yes (laser-etched) No Yes Yes Yes No Yes	Yes (laser-etched) No Yes Yes Yes No Yes	Yes (laser-etched) No Yes Yes Yes No Yes	Yes (laser-etched) No Yes Yes Yes No Yes
Vapor phase LN2 to + 140°C ++/+	Vapor phase LN2 to + 140°C ++/+	Vapor phase LN2 to + 140°C ++/+	Vapor phase LN2 to + 140°C ++/+



The Micronic ULT Rack Range is developed to securely store samples down to ultra-low temperatures. Absolute traceability and reproducibility on the racks is ensured through novel laser-etched alphanumeric visual location aids on top of the racks and a unique laser etched 1D barcode on the side of the racks.

ULT Rack Range

96-well format



Resistance to extreme conditions







Superior features

- Dimensions based on the Society for Laboratory Automation and Screening (ANSI / SLAS) standards for storage racks
- Extremely strong design which minimizes deformation due to temperature changes
- Manufactured from Polycarbonate which has excellent properties for low temperatures (vapor phase LN2)
- Highly transparent cover
- Standard available with laser etched 1D barcode on rack side and optional 2D Data-Matrix code on rack bottom
- Unique laser etched Alphanumeric coding on top
- Rack orientation marks on bottom and side
- Secure and safe locking system
- Twist-lock
- Open rack bottom
- Compatible with the Micronic Rack Readers
- Class 7 clean room production
- RNase/DNase and Pyrogen free

Additional options

- Sterilization using gamma irradiation or Eto treatment
- Customizable 1D rack barcode

Specifications

 <p>See next page</p>		Compatible with tubes from 0.30ml to 2.00ml
		12 rows of 8 tubes (96 tubes)
		Polycarbonate
		Length: 127.8mm (5.03 inches), width: 85.5mm (3.37 inches)
		Resistant to Chemical solvents
		Vapor phase LN2 to +140°C



Dimensions

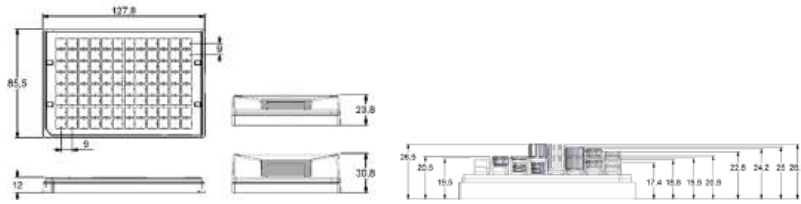

Micronic 96-1 rack dimensions and tube in rack dimensions
Left: 0.50ml internally threaded tubes with TPE Push Caps / Low Profile Screw Caps or Screw Caps. Right: 0.30ml / 0.40ml externally threaded tubes with Screw Caps / Screw Caps IG or Push Caps.

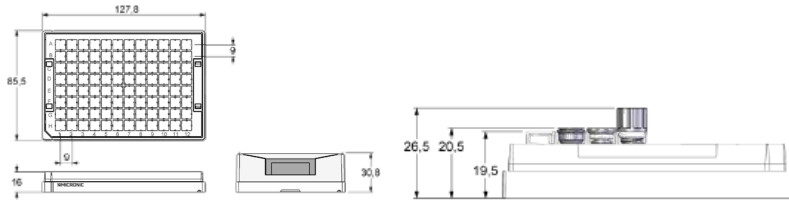

Micronic 96-Q1 rack dimensions and tube in rack dimensions
0.50ml internally threaded tubes with TPE Push Caps / Low Profile Screw Caps or Screw Caps

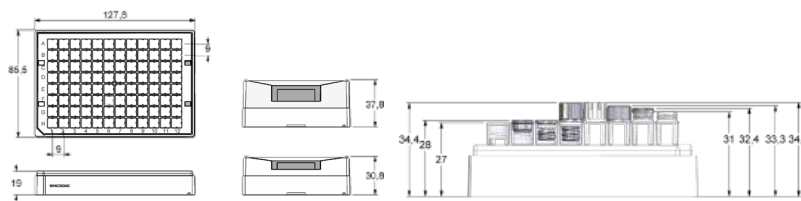

Micronic 96-2 rack dimensions and tube in rack dimensions
Left: 0.75ml internally threaded tubes with TPE Push Caps / Low Profile Screw Caps or Screw caps. Right: 0.75ml externally threaded tubes (Hybrid) with Screw Caps / Screw Caps IG or Push Caps.

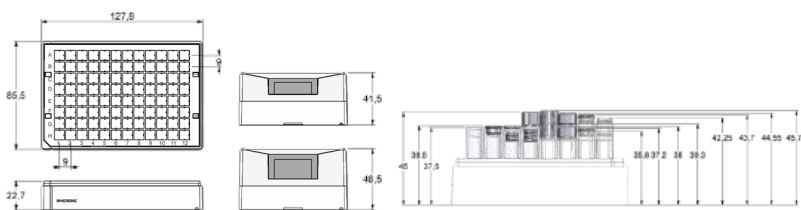

Micronic 96-3 rack dimensions and tube in rack dimensions
Left: 1.10ml internally threaded tubes with TPE Push Caps / Low Profile Screw Caps or Screw Caps. Right: 0.80ml / 1.10ml externally threaded tubes with Screw Caps / Screw Caps IG or Push Caps.

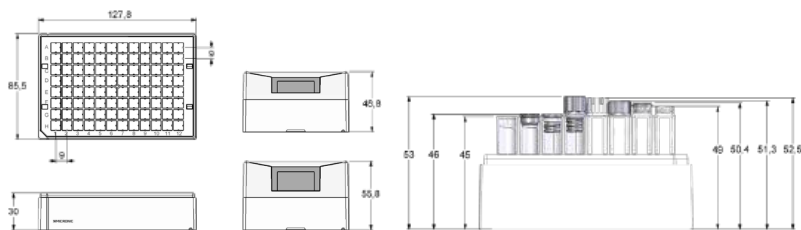

Micronic 96-4 rack dimensions and tube in rack dimensions
Left: 1.40ml internally threaded tubes (Hybrid) with TPE Push Caps / Low Profile Screw Caps or Screw Caps. Right: 1.40ml externally threaded tubes (Hybrid) with Screw Caps / Screw Caps IG or Push Caps.

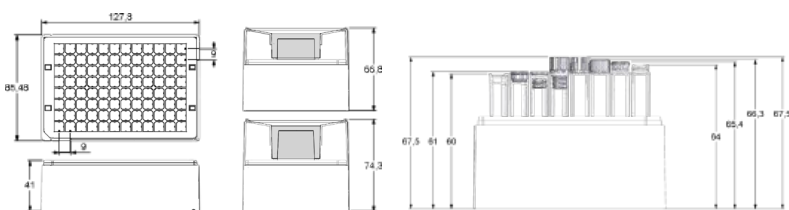

Micronic 96-5 rack dimensions and tube in rack dimensions
Left: 2.00ml internally threaded tubes with TPE Push Caps / Low Profile Screw Caps or Screw Caps. Right: 2.00ml externally threaded tubes with Screw Caps / Screw Caps IG or Push Caps.

Ordering information

Catalog number	Description	Case Size
Tube storage racks in 96-well ANSI/SLAS standard format (empty)		
MP51200	Micronic 96-1 Rack with low cover for 0.30ml tubes capped with Screw Caps	4 x 10 racks
MP51201	Micronic 96-1 Rack with low cover for 0.50ml tubes capped with Push Caps or (Low Profile) Screw Caps	4 x 10 racks
MP51214	Micronic 96-Q1 Rack with low cover for 0.50ml tubes capped with Push Caps or Low Profile Screw Caps	4 x 10 racks
MP51204	Micronic 96-2 Rack with low cover for 0.75ml tubes capped with Push Caps or Low Profile Screw Caps	4 x 10 racks
MP51217	Micronic 96-3 Rack with low cover for 0.80ml tubes capped with Screw Caps	4 x 10 racks
MP51207	Micronic 96-3 Rack with low cover for 1.10ml tubes capped with Push Caps or Low Profile Screw Caps	4 x 10 racks
MP51210	Micronic 96-4 Rack with low cover for 1.40ml tubes capped with Push Caps or Low Profile Screw Caps	4 x 10 racks
MP51215	Micronic 96-5 Rack with low cover for 2.00ml tubes capped with Push Caps or Low Profile Screw Caps	4 x 6 racks

Other item numbers are available with high cover and bottom rack ID

The Micronic 48-well format ULT Racks can hold 6 x 8 (48) individual tubes. Next to the standard ANSI/SLAS footprint, the ULT Racks are provided with more features ideal for automation. For example: an outstanding Twist-Lock design which prevents tubes from turning during screw (de)capping and closed side walls with minimal notches.



ULT Rack Range

48-well format



Sturdy design







Superior features

- Dimensions based on the Society for Laboratory Automation and Screening (ANSI / SLAS) standards for storage racks
- Extremely strong design which minimizes deformation due to temperature change
- Manufactured from Polycarbonate which has excellent properties for low temperatures (vapor phase LN2)
- Highly transparent cover
- Standard available with laser etched 1D rack barcode
- Unique laser etched Alphanumeric coding on top
- Rack orientation marks on bottom and side
- Secure and safe locking system
- Twist-lock
- Open rack bottom
- Compatible with the Micronic Rack Readers
- Class 7 clean room production
- RNase/DNase and Pyrogen free

Additional options

- Sterilization using gamma irradiation or Eto treatment
- Customizable 1D rack barcode

Specifications

 <p>See next page</p>		Compatible with tubes from 1.00ml to 4.00ml
		8 rows of 6 tubes (48 tubes)
		Polycarbonate
		Length: 127.8mm (5.03 inches), width: 85.5mm (3.37 inches)
		Resistant to Chemical solvents
		Vapor phase LN2 to +140°C



Dimensions

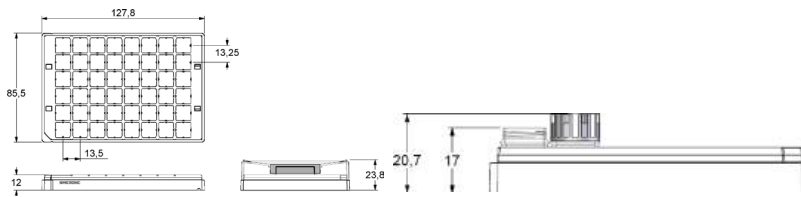

Micronic 48-1 rack dimensions and tube in rack dimensions
1.00ml externally threaded tubes with Screw Caps.

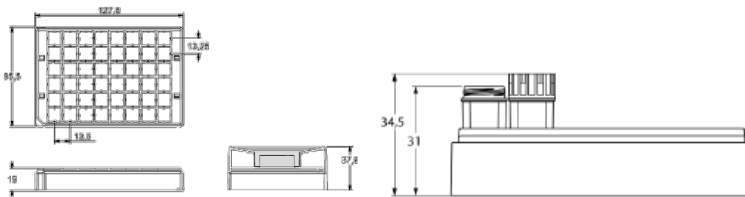

Micronic 48-2 rack dimensions and tube in rack dimensions
2.00ml externally threaded Hybrid tubes with Screw Caps.

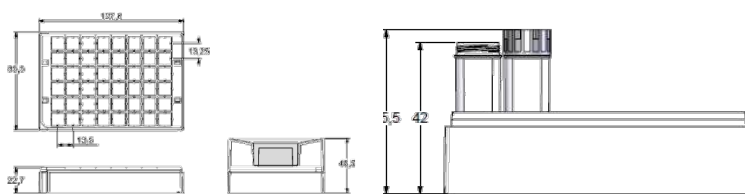

Micronic 48-3 rack dimensions and tube in rack dimensions
3.00ml externally threaded Hybrid tubes with Screw Caps.

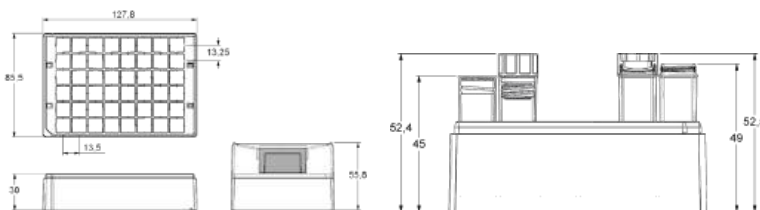

Micronic 48-4 rack dimensions and tube in rack dimensions
Left: 4.00ml internally threaded tubes with Screw Caps.
Right: 4.00ml externally threaded tubes with Screw Caps.

Ordering information

Catalog number	Description	Case Size
Tube storage racks in 48-well ANSI/SLAS standard format (empty)		
MP51304	Micronic 48-1 Rack with low cover for 1.00ml tubes capped with Screw Caps	4 x 10 racks
MP51303	Micronic 48-2 Rack with high cover for 2.00ml tubes capped with Screw Caps	4 x 10 racks
MP51302	Micronic 48-3 Rack with high cover for 3.00ml tubes capped with Screw Caps	4 x 10 racks
MP51301	Micronic 48-4 Rack with high cover for 4.00ml tubes capped with Screw Caps	2 x 10 racks

Micronic ULT Rack

Sandra Story
Status: Reviewer
Member since: 2020
Organization: NUBAD, LLC

“Everyone loves this product that helps efficiency and organization.”

Rating: 4.3 ★★★★★

Application Area: Drug development stability storage

*The multitube rack is a perfect fit for our liquid handler. Keeping track of inventory is no longer a complicated chore and we have confidence in the long term storage stability and that our product can be shipped safely!

Review date: 27 Mar 2020 | Micronic ULT 96-4 Rack

Ease of use

★★★★★

★★★★☆

★★★★☆

The Micronic 24-well format racks are made from Polycarbonate and have excellent properties for low temperature conditions. The material used to manufacture the racks is selected on quality and the highest purity levels. The racks have an extremely strong design which minimizes deformation due to temperature changes.

ULT Rack Range

24-well format









Superior features

- Dimensions based on the Society for Laboratory Automation and Screening (ANSI / SLAS) standards for storage racks
- Extremely strong design which minimizes deformation due to temperature changes
- Manufactured from Polycarbonate which has excellent properties for low temperatures (vapor phase LN2)
- Highly transparent cover
- Standard available with laser etched 1D rack barcode
- Unique laser etched Alphanumeric coding on top
- Rack orientation marks on bottom and side
- Secure and safe locking system
- Twist-lock
- Open rack bottom
- Compatible with the Micronic Rack Readers
- Class 7 clean room production
- RNase/DNase and Pyrogen free

Additional options

- Sterilization using gamma irradiation or Eto treatment
- Customizable 1D rack barcode

Specifications

 <p>See next page</p>		Compatible with tubes from 1.50ml to 6.00ml
		6 rows of 4 tubes (24)
		Polycarbonate
		Length: 127.8mm (5.03 inches), width: 85.5mm (3.37 inches)
		Resistant to Chemical solvents
		Vapor phase LN2 to +140°C



Dimensions

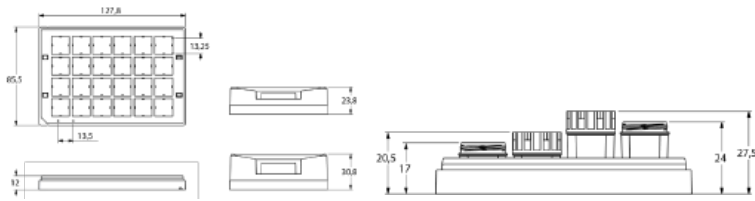

Micronic 24-1 rack dimensions and tube in rack dimensions
Left: 1.50ml externally threaded (Hybrid) tubes with Screw Caps. Right: 3.00ml externally threaded (Hybrid) tubes with Screw Caps.

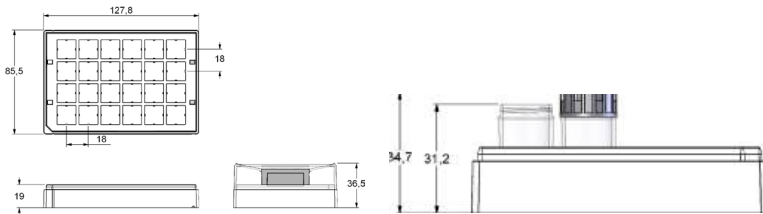

Micronic 24-2 rack dimensions and tube in rack dimensions
3.50ml externally threaded tubes with Screw Caps

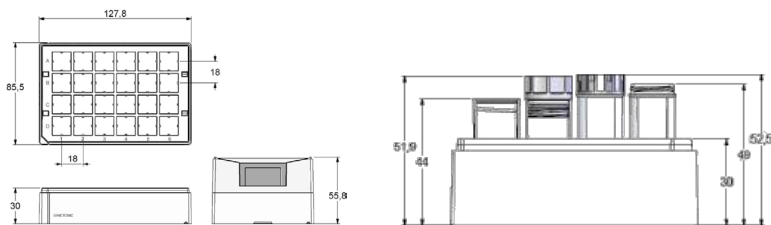

Micronic 24-4 rack dimensions and tube in rack dimensions
Left: 6.00ml internally threaded tubes with Screw caps. Right: 6.00ml externally threaded tubes (Hybrid) with Screw Caps.

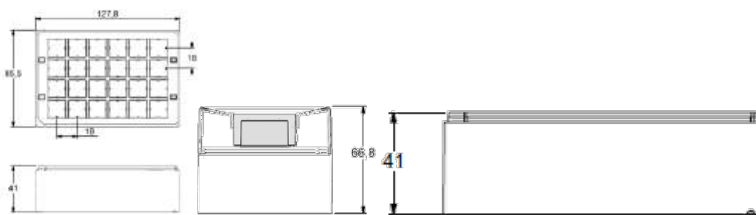

Micronic 24-5 rack dimensions
High volume tubes.

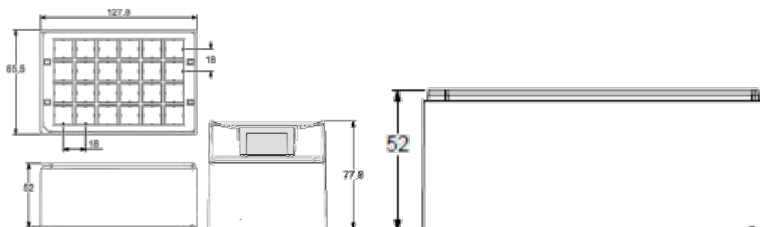

Micronic 24-6 rack dimensions
High volume tubes.

Ordering information

Catalog number	Description	Case Size
Tube storage racks in 24-well ANSI/SLAS standard format (empty)		
MP51404	Micronic 24-1 Rack with low cover for 1.50ml tubes capped with Screw Caps	4 x 10 racks
MP51406	Micronic 24-1 Rack with high cover for 3.00ml tubes capped with Screw Caps	4 x 10 racks
MP51409	Micronic 24-2 Rack with high cover for 3.50ml tubes capped with Screw Caps	4 x 10 racks
MP51403	Micronic 24-4 Rack with high cover for 6.00ml tubes capped with Screw Caps	2 x 10 racks
MP51407	Micronic 24-5 Rack with low cover for tubes capped with Screw Caps	4 x 6 racks
MP51408	Micronic 24-6 Rack with low cover for tubes capped with Screw Caps	4 x 6 racks

The Micronic 138-well format HD Rack is made to store more samples in an ANSI/SLAS format rack, and is especially designed to be compatible with automated processes. The rack walls are closed for easy gripping with most robotic arms. In addition, the rack uses a unique open bottom design, which permits tubes to be manipulated by robotic systems.



Dimensions

Micronic 138-2 rack dimensions and tube in rack dimensions

Left: 0.75ml internally threaded tubes with TPE Push Caps / Low Profile Screw Caps or Screw Caps. Right: 0.75ml / 0.80ml externally threaded (hybrid) tubes with TPE Push Caps / Screw Caps IG or Screw Caps.

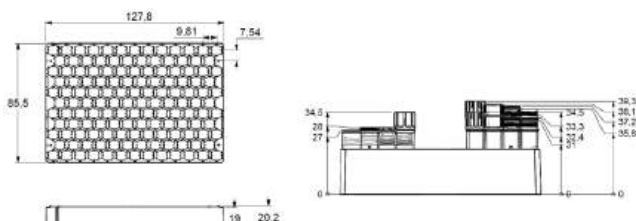

Superior features

- Dimensions based on the Society for Laboratory Automation and Screening (ANSI / SLAS) standards for storage racks
- Extremely strong design which minimizes deformation due to temperature change
- Manufactured from Polycarbonate which has excellent properties for low temperatures (vapor phase LN2)
- Class 7 clean room production
- RNase/DNase and Pyrogen free
- Rack side walls are closed for easy and various gripping of most robotic arms
- Standard available with laser etched 1D barcode
- Twist-lock
- Compatible with automated storage systems
- Compatible with Micronic Rack Reader DR700 range

Additional options

- Sterilization using gamma irradiation or Eto treatment
- Customizable 1D rack barcode

Ordering information

Catalog number	Description	Case Size
MP51420	Micronic 138-2 HD Rack without cover for 0.75ml tubes	4 x 10 racks

Specifications 138-well HD Rack

<p>See next page</p>		Compatible with tubes from 0.75 to 0.80ml
		6 rows of 13 tubes and 5 rows of 12 tubes (138)
		Polycarbonate
		Length: 127.8mm (5.03 inches), width: 85.5mm (3.37 inches)
		Resistant to Chemical solvents
		Vapor phase LN2 to +100°C



Precision manufactured in a certified class 7 clean room production facility, this rack is based on the Society for Laboratory Automation and Screening (ANSI/SLAS) standards for storage racks. The racks are designed to hold 96 individual storage tubes, also known as 96-well configuration.



Dimensions

Comorack-96 dimensions and tube in rack dimensions
1.40ml internally threaded tubes with TPE Push Caps.

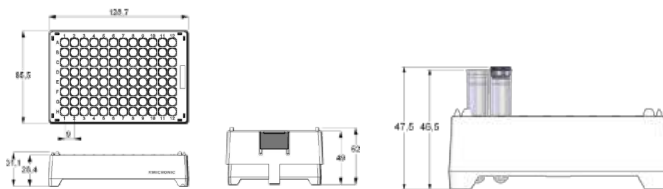

Superior features

- Dimensions based on the Society for Laboratory Automation and Screening (ANSI / SLAS) standards for storage racks
- Extremely strong design which minimizes deformation due to temperature change
- Manufactured from Polycarbonate which has excellent properties for low temperatures (vapor phase LN2)
- Class 7 clean room production
- RNase/DNase and Pyrogen free
- Compatible with the complete Micronic Rack Reader Range

Additional options

- Sterilization using gamma irradiation or Eto treatment
- Customizable 1D rack barcode

Ordering information

Catalog number	Description	Case Size
MP22504	Comorack-96 (including cover) (polycarbonate)	4 x 10 racks

Specifications Comorack

		Compatible with tubes from 0.50 to 2.00ml
		12 rows of 8 tubes (96)
		Polycarbonate
		Length: 127.8mm (5.03 inches), width: 85.5mm (3.37 inches)
		Resistant to Chemical solvents
		Vapor phase LN2 to +121°C



[VIEW PRODUCT ONLINE](#)



Serving
scientists
since 1984

Certified
Class 7 clean
room manu-
facturing

SAMPLE STORAGE CAPS

Micronic offers the most extensive range of tube capping products, including screw caps and push caps, in the market. For effective cryogenic storage, a screw cap is recommended since it allows for the tightest seal possible. For storage from -80°C and above, either a push cap (TPE Capcluster) or a screw cap can be used. All tubes have an upper screw thread or double o-ring design providing a perfect seal and closure ensuring maximum sample integrity. The Micronic push caps are available in 96-format and the screw caps in 96-, 48-, and 24 format. All sealing products are available in a range of colors!

Industry
leading cap
range



Superior features of Micronic Sample Storage Caps

All Screw Caps are manufactured from virgin plastic raw material, RNase/DNase and pyrogen free, automation friendly and have a temperature range of Vapor phase LN2 to +100°C

Caps for tubes with internal thread

High quality Silicon O-ring allows for optimal sealing for tubes with internal thread

Available in 12 colors



Caps for tubes with external thread

Triple start thread allows for the tightest seal possible for tubes with external thread

Available in 12 colors



TPE Push Caps for tubes with internal & external thread

Multi-piercable without losing sealing integrity

Available with split septum to pierce with a pipette tip

RNase / DNase and Endotoxin (pyrogen) free



Temperature range: -80°C to +100°C

TPE Caps in Natural: manufactured from materials for medical or non-medical applications

Available in Natural + 12 colors



Standard Micronic cap color coding guide from sample storage tubes

During the collection, processing and storage of samples, sample traceability is crucial. While most laboratories use 1D and 2D barcodes on sample tubes to ensure traceability of samples, cap color inspection will further promote the tube identification process. Cap color coding in laboratories is particularly useful when used to distinguish between different types of research purposes. Color provides a visual clue that works faster than text alone. By adding cap color coding next to 1D and 2D barcodes, users can speed up sample storage and retrieval time, eliminate human errors, and reduce the risk of lost samples.



To ensure that aliquots, which are transferred from sample collection tubes (vacuum tubes) into smaller sample storage tubes can still be identified by cap color inspection, Micronic offers a standard cap color coding solution for 96-, 48- and 24-format sample storage tubes. This solution is related to the cap colors of vacuum tubes. To each type of blood sample (i.e. additive which is present to pre-treat or preserve the blood), a cap color is assigned. Next to blood samples, the cap color solution can also be used for other biological samples (e.g. DNA, tissue, urine, feces, plants, or seeds).

For more information about the standard cap color coding guide, please see Micronic's Tech Note 'Cap Color Coding' on our website www.micronic.com!

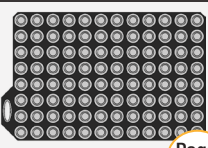
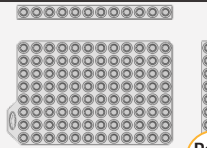
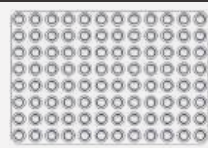

[VIEW BLOG POST ONLINE](#)

	SCREW CAP-96	SCREW CAP-48	SCREW CAP-24	LOW PROFILE SC
CAPS FOR TUBES WITH INTERNAL THREAD	 	 	 	 
Cap material	PP + Silicon O-ring	PP + Silicon O-ring	PP + Silicon O-ring	PP + Silicon O-ring
Capping for # tubes	1	1	1	1
Format	Single cap for 96-format tubes	Single cap for 48-format tubes	Single cap for 24-format tubes	Single cap for 96-format tubes
Compatible tubes	0.50ml, 0.75ml, 1.10ml, 1.40ml, 2.00ml	4.00ml	6.00ml	0.50ml, 0.75ml, 1.10ml, 1.40ml, 2.00ml
Colors*	12 different colors	12 different colors	12 different colors	12 different colors
Piercable	No	No	No	No
Available as pre-split	No	No	No	No
Re-usable	Yes	Yes	Yes	Yes
Sterilization option	Yes	Yes	Yes	Yes
Available DNase / RNase free	Yes	Yes	Yes	Yes
Class 7 clean room production	Yes	Yes	Yes	Yes
Minimum storage temperature**	Vapor phase LN2	Vapor phase LN2	Vapor phase LN2	Vapor phase LN2
Chemical resistance	++	++	++	++
	SCREW CAP-96	SCREW CAP-48	SCREW CAP-24	SCREW CAP 1G
CAPS FOR TUBES WITH EXTERNAL THREAD	 	 	 	 
Cap material	PE	PE	PE	PE
Capping for # tubes	1	1	1	1
Format	Single cap for 96-format tubes	Single cap for 48-format tubes	Single cap for 24-format tubes	Single cap for 96-format tubes
Compatible tubes	0.30ml, 0.40ml, 0.75ml, 0.80ml, 1.10ml, 1.40ml, 200ml	1.00ml, 2.00ml, 3.00ml, 4.00ml	1.50ml, 3.00ml, 3.50ml, 6.00ml	0.30ml, 0.40ml, 0.75ml, 0.80ml, 1.10ml, 1.40ml, 2.00ml
Colors*	Transparent + 12 different colors	Transparent + 12 different colors	Transparent + 12 different colors	Transparent + 12 different colors
Re-usable	Yes	Yes	Yes	Yes
Sterilization option	Yes	Yes	Yes	Yes
DNase / RNase free	Yes	Yes	Yes	Yes
Class 7 clean room production	Yes	Yes	Yes	Yes
Minimum storage temperature**	Vapor phase LN2	Vapor phase LN2	Vapor phase LN2	Vapor phase LN2
Chemical resistance	++	++	++	++

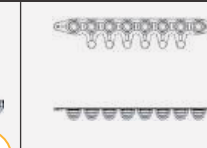
TPE CAPCLUSTER	TPE CAPMAT	EVA CAPMAT	EVA CAPBAND	EVA BREAK-OFF
 Page 66	 Page 66	 Page 67	 Page 67	 Page 67
TPE 96 or 1 Mat of 96 individual caps 0.50ml, 0.75ml, 1.10ml, 1.40ml, 2.00ml, 2.50ml	TPE (LYO) 96, 12 or 8 Mat of 96 caps 0.50ml, 0.75ml, 1.10ml, 1.40ml, 2.00ml, 2.50ml	EVA 96 Mat op 96 caps 0.50ml, 0.75ml, 1.10ml, 1.40ml, 2.00ml, 2.50ml	EVA 8 Strip of 8 caps 0.50ml, 0.75ml, 1.10ml, 1.40ml, 2.00ml, 2.50ml	EVA 8 or 1 Strip of 8 caps 0.50ml, 0.75ml, 1.10ml, 1.40ml, 2.00ml, 2.50ml
Natural + 12 different colors Yes Yes No Yes Yes Yes -80°C +++	Natural + 7 different colors Yes Yes No Yes Yes Yes -80°C +++	Transparent No No No Yes Yes Yes -40°C ++	Transparent No No No Yes Yes Yes -40°C ++	Transparent No No No Yes Yes Yes -40°C ++

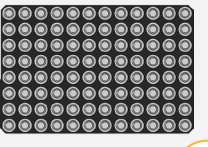
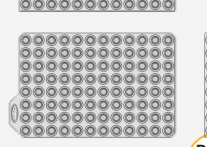
TPE CAPCLUSTER	TPE CAPMAT
 Page 66	 Page 66
TPE 96 or 1 Mat of 96 individual caps 0.30ml, 0.40ml, 0.75ml, 0.80ml, 1.10ml, 1.40ml, 2.00ml	TPE 96 or 1 Mat of 96 caps 0.30ml, 0.40ml, 0.75ml, 0.80ml, 1.10ml, 1.40ml, 2.00ml
Natural + 12 different colors No Yes Yes Yes -80°C +++	Natural + 7 different colors No Yes Yes Yes -80°C +++

* Please be aware that great care was taken to develop and thoroughly test the caps to secure the stability of the colors. However, as it is not possible to cover all applications, we recommend users to test the colored caps within their own applications.

** Temperature range of the material of the tubes, caps and racks is approved from -80°C to +100°C. In practice with Screw Caps are used in lower temperatures until *vapor phase* LN2 (-150°C to -196°C). Micronic does not recommend to store tubes in liquid phase nitrogen. In practice tubes are only snap frozen in LN2 (without submerging the cap).



Micronic Screw Caps-96 provide a secure closure for long-term sample storage at ultra-low temperatures. To meet the diverse needs of different researchers, Micronic offers a range of sealing solutions. Tubes with Internal Thread can be sealed with the classic Screw Cap, the Screw Cap Ultra and the Low Profile Screw Cap.









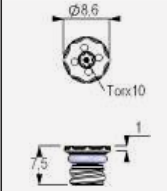

Superior features

- Low Profile Screw Caps save freezer space up to 33%!
- Screw Caps feature a high quality Silicon O-ring
- Available in 12 different colors: Grey, White, Yellow, Orange, Red, Pink, Purple, Blue, Light Blue, Light Green, Green and Black
- The Screw Cap Ultra is available in 4 different colors: Yellow, Red, Blue and Light Green
- Automation friendly
- Ideal for sample storage at ultra-low temperatures or for sample transportation
- Compatible with Micronic internally threaded Screw Cap tubes in 96-, 48-, or 24-format
- Small packaging of 960, 480, 240 caps
- Resists chemical solvents
- Class 7 clean room production
- RNase/DNase and Pyrogen free

Additional options

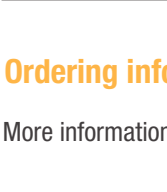
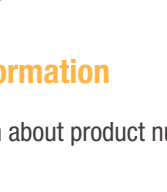
- Sterilization using gamma irradiation or Eto treatment
- Precapped on Micronic Screw Cap tubes

Specifications

			Compatible with Screw Cap tubes from 0.50ml to 6.00ml
			Compatible with tubes in 96-, 48- and 24-well format
			Polypropylene with Silicon O-ring
	See drawings on the left		
	Resistant to Chemical solvents		
	Vapor phase LN2 to +100°C		

Ordering information

More information about product numbers and ordering, see page 68.



Tubes with External Thread can be sealed by standard Screw Caps or the Screw Caps IG for Tubes with External Thread. Using externally threaded storage tubes eliminates the possibility of the sample coming into contact with the screw thread, minimizing chance of cross-contamination while improving sample integrity.



Superior features

- Triple start thread for optimal sealing quality
- Available in transparent and 12 different colors: Grey, White, Yellow, Orange, Red, Pink, Purple, Blue, Light Blue, Light Green, Green and Black
- Automation friendly
- Screw Cap IG has an improved gripping for both manually and automated handling
- The Screw Cap IG has a newly designed lead-in on top of the Screw Cap which ensures a better tube placement
- Ideal for sample storage at ultra-low temperatures or for sample transportation
- Compatible with Micronic externally threaded Screw Cap tubes in 96-, 48-, or 24-format
- Small packaging of 960, 480 or 240 caps
- Resists chemical solvents
- Class 7 clean room production
- RNase/DNase and Pyrogen free



Additional options

- Sterilization using gamma irradiation or Eto treatment
- Precapped on Micronic Screw Cap tubes

Specifications

			Compatible with Screw Cap tubes from 0.30ml to 6.00ml
			Compatible with tubes in 96-, 48-, and 24-well format
			Polyethylene
			See drawings on the left
			Resistant to Chemical solvents
			Vapor phase LN2 to +100°C

Ordering information

More information about product numbers and ordering, see page 68.



VIEW PRODUCT ONLINE

The TPE Push Caps are compatible with tubes in 96-well format (internal and external thread). Several TPE cap formats are available: the Capcluster-96 which leaves each tube individually capped, the Capmat-96 holds 96 caps in a fixed foil in which the tubes are sealed together, and the Capband-8 or -12 comes in a mat format with tear off lines to obtain cap strips.



Superior features

- Caps can be pierced repeatedly without losing seal integrity
- Available in Natural and 12 different colors: Grey, White, Yellow, Orange, Red, Pink, Purple, Blue, Light Blue, Light Green, Green and Black (Capcluster-96)
- TPE Caps in Natural: manufactured from materials for medical or non-medical applications
- Capmats and Capclusters (patented) are compatible with tubes with internal and external thread in 96-format
- Economical solution storage at temperatures down to -80°C
- Resists chemical solvents
- Class 7 clean room production
- RNase/DNase and Pyrogen free
- Special TPE push cap for tubes with internal thread: **Lyo Caps-96**, which are specially developed for the lyophilization process as vents in the caps allow vapor to escape from the tubes

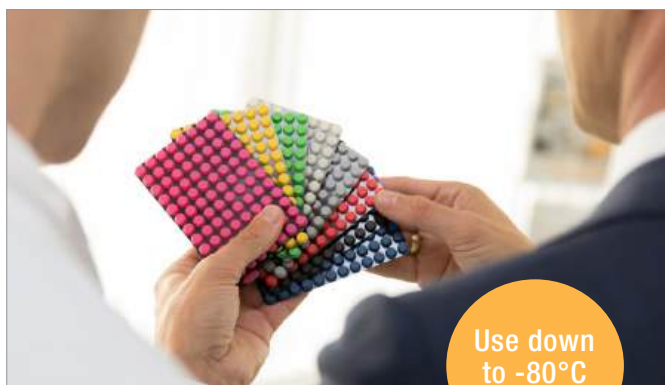

Additional options

- Sterilization using gamma irradiation or Eto treatment
- Precapped on Micronic tubes
- Split septum to pierce with a pipette tip

Specifications

		Compatible with Push Cap and Screw Cap tubes from 0.30ml to 2.00ml
		Compatible with tubes in 96-well format
		Thermo Plastic Elastomer (Virgin)
		See drawing on the left
		Resistant to Chemical solvents
		-80°C to +100°C (without retaining foil)

Ordering information

More information about product numbers and ordering, see page 69.



The EVA Push Caps are a cost effective way to securely close sample storage tubes in a 96-well format. The EVA Push Caps for tubes in 96-well format are compatible with the 0.50ml, 0.75ml, 1.10ml, 1.40ml and 2.00ml. The caps are compatible with Micronic Capping Equipment.



Internal thread

96-well format

Superior features

- Easy solution
- Available in Transparent
- Compliant with the US and European Food contact regulations
- Compatible with Micronic tubes in 96-well format
- Resists chemical solvents
- Class 7 clean room production
- RNase/DNase and Pyrogen free

Additional options

- Sterilization using gamma irradiation or Eto treatment







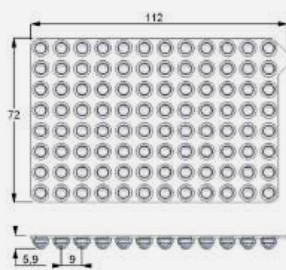

MANUAL DECAPPERS

We developed a variety of decappers for the manual removal of Push Caps and Screw Caps. Our Manual Decappers secure a quick and easy removal of the caps, and are compatible with a variety of brands.



Specifications

		Compatible with tubes from 0.50ml to 2.00ml
		Compatible with tubes in 96-well format
		Ethyl Vinyl Acetate
		See drawing on the left
		Resistant to Chemical solvents
		-40°C to +100°C

Ordering information

More information about product numbers and ordering, see page 69.



VIEW PRODUCT ONLINE

SCREW CAPS internal thread

from page 64

Catalog number	Description	Case Size
Screw Caps Classic for internally threaded tubes in 96-well format*		
MP53120	Screw Caps for internally threaded tubes in 96-well format - Grey	1 x 960 caps
MP53101	Screw Caps for internally threaded tubes in 96-well format - White	1 x 960 caps
MP53104	Screw Caps for internally threaded tubes in 96-well format - Yellow	1 x 960 caps
MP53130	Screw Caps for internally threaded tubes in 96-well format - Orange	1 x 960 caps
MP53102	Screw Caps for internally threaded tubes in 96-well format - Red	1 x 960 caps
MP53121	Screw Caps for internally threaded tubes in 96-well format - Pink	1 x 960 caps
MP53109	Screw Caps for internally threaded tubes in 96-well format - Purple	1 x 960 caps
MP53103	Screw Caps for internally threaded tubes in 96-well format - Blue	1 x 960 caps
MP53124	Screw Caps for internally threaded tubes in 96-well format - Light Blue	1 x 960 caps
MP53123	Screw Caps for internally threaded tubes in 96-well format - Light Green	1 x 960 caps
MP53105	Screw Caps for internally threaded tubes in 96-well format - Green	1 x 960 caps
MP53122	Screw Caps for internally threaded tubes in 96-well format - Black	1 x 960 caps
Screw Caps Ultra for internally threaded tubes in 96-well format		
MP53354	Screw Caps Ultra for internally threaded tubes in 96-well format - Yellow	1 x 960 caps
MP53352	Screw Caps Ultra for internally threaded tubes in 96-well format - Red	1 x 960 caps
MP53353	Screw Caps Ultra for internally threaded tubes in 96-well format - Blue	1 x 960 caps
MP53373	Screw Caps Ultra for internally threaded tubes in 96-well format - Light Green	1 x 960 caps

* Other item numbers are available for Screw Caps Low Profile in 96-format, Screw Caps in 48-format and Screw Caps in 24-format.

SCREW CAPS external thread

from page 65

Catalog number	Description	Case Size
Screw Caps IG for externally threaded tubes in 96-well format		
MP53870	Screw Caps IG for externally threaded tubes in 96-well format - Transparent	1 x 960 caps
MP53871	Screw Caps IG for externally threaded tubes in 96-well format - Grey	1 x 960 caps
MP53872	Screw Caps IG for externally threaded tubes in 96-well format - White	1 x 960 caps
MP53873	Screw Caps IG for externally threaded tubes in 96-well format - Yellow	1 x 960 caps
MP53874	Screw Caps IG for externally threaded tubes in 96-well format - Orange	1 x 960 caps
MP53875	Screw Caps IG for externally threaded tubes in 96-well format - Red	1 x 960 caps
MP53876	Screw Caps IG for externally threaded tubes in 96-well format - Pink	1 x 960 caps
MP53877	Screw Caps IG for externally threaded tubes in 96-well format - Purple	1 x 960 caps
MP53878	Screw Caps IG for externally threaded tubes in 96-well format - Blue	1 x 960 caps
MP53879	Screw Caps IG for externally threaded tubes in 96-well format - Light Blue	1 x 960 caps
MP53880	Screw Caps IG for externally threaded tubes in 96-well format - Light Green	1 x 960 caps
MP53881	Screw Caps IG for externally threaded tubes in 96-well format - Green	1 x 960 caps
MP53882	Screw Caps IG for externally threaded tubes in 96-well format - Black	1 x 960 caps
Screw caps for externally threaded tubes in 96-well format*		
MP53825	Screw Caps for externally threaded tubes in 96-well format - Transparent	1 x 960 caps
MP53820	Screw Caps for externally threaded tubes in 96-well format - Grey	1 x 960 caps
MP53801	Screw Caps for externally threaded tubes in 96-well format - White	1 x 960 caps
MP53804	Screw Caps for externally threaded tubes in 96-well format - Yellow	1 x 960 caps
MP53800	Screw Caps for externally threaded tubes in 96-well format - Orange	1 x 960 caps

* Other colors are available for Screw Caps for 96-well format and other item numbers are available for Screw Caps for externally threaded tubes in 48- and 24-well format.

TPE PUSH CAPS internal and external thread

from page 66

Catalog number	Description	Case Size
Pierceable TPE Capclusters for capping 96 individual tubes with External thread*		
MP53970	Pierceable TPE Capcluster Natural for capping 96 individual tubes with External Thread	4 x 10 clusters
Pierceable TPE Capclusters for capping 96 individual tubes with Internal thread		
MP53065	Pierceable TPE Capcluster Natural for capping 96 individual tubes with Internal Thread	4 x 10 clusters
MP53068	Pierceable TPE Capcluster Grey for capping 96 individual tubes with Internal Thread	4 x 10 clusters
MP53073	Pierceable TPE Capcluster White for capping 96 individual tubes with Internal Thread	4 x 10 clusters
MP53072	Pierceable TPE Capcluster Yellow for capping 96 individual tubes with Internal Thread	4 x 10 clusters
MP53043	Pierceable TPE Capcluster Orange for capping 96 individual tubes with Internal Thread	4 x 10 clusters
MP53044	Pierceable TPE Capcluster Red for capping 96 individual tubes with Internal Thread	4 x 10 clusters
MP53069	Pierceable TPE Capcluster Pink for capping 96 individual tubes with Internal Thread	4 x 10 clusters
MP53077	Pierceable TPE Capcluster Purple for capping 96 individual tubes with Internal Thread	4 x 10 clusters
MP53066	Pierceable TPE Capcluster Blue for capping 96 individual tubes with Internal Thread	4 x 10 clusters
MP53045	Pierceable TPE Capcluster Light Blue for capping 96 individual tubes with Internal Thread	4 x 10 clusters
MP53067	Pierceable TPE Capcluster Light Green for capping 96 individual tubes with Internal Thread	4 x 10 clusters
MP53046	Pierceable TPE Capcluster Green for capping 96 individual tubes with Internal Thread	4 x 10 clusters
MP53071	Pierceable TPE Capcluster Black for capping 96 individual tubes with Internal Thread	4 x 10 clusters
Pierceable TPE Capmats for capping 96 tubes with External thread*		
MP53990	Pierceable TPE Capmat Natural for capping 96 tubes with External Thread	4 x 10 mats
Pierceable TPE Capmats for capping 96 tubes with Internal thread*		
MP53081	Pierceable TPE Capmat Natural for capping 96 tubes with Internal Thread	4 x 10 mats
MP53084	Pierceable TPE Capmat Grey for capping 96 tubes with Internal Thread	4 x 10 mats
Pierceable TPE Capbands for capping tubes with Internal thread*		
MP53089	Pierceable TPE Capband Natural in Capmat format for capping 8 tubes with Internal Thread	4 x 10 mats
MP53098	Pierceable TPE Capband Natural in Capmat format for capping 12 tubes with Internal Thread	4 x 10 mats
TPE Push Caps RB for capping tubes with Internal thread		
MP53925	Pierceable TPE Capcluster Natural RB for capping 96 individual tubes with Internal Thread	24 x 10 clusters
MP53930	Split TPE Capcluster Natural RB for capping 96 individual tubes with Internal Thread	24 x 10 clusters
MP53940	Split TPE Capband Natural RB for capping 8 tubes with Internal Thread	24 x 10 clusters
Lyo Capclusters for capping 96 individual tubes with Internal thread (large pack)*		
MP53042	Lyo Capclusters for capping 96 individual tubes with Internal Thread	24 x 10 clusters

* Other colors and item numbers are available for TPE Push Caps

EVA PUSH CAPS internal thread

from page 67

Catalog number	Description	Case Size
EVA Capping Range		
MP82605	EVA Capband break-off for capping 1 tube	4 x 1000 bands
MP2271B1	EVA Capband for capping 8 tubes	24 x 120 bands
MP33000	EVA Capmat for capping 96 tubes	24 x 10 mats
MP33001	EVA Capmat for capping 96 tubes for Comorack-96 only (polycarbonate)	24 x 10 mats
Manual Decapping Products		
MP54000	Manual Decapper-1	10 pieces
MP54001	Manual Decapper-8	10 pieces
MP65010	Manual Decapper-8 (Aluminum)	1 unit
MP54004	Screw Cap Remover	10 pieces



Assembled in
The Netherlands
and the United
States

Continuous
innovation in
sample handling
equipment

SAMPLE HANDLING EQUIPMENT

To enable fast, accurate and efficient sample identification, Micronic offers an extensive code reader range which consists of single tube scanners and whole rack scanners. The scanners can read coded 24-, 48- and 96-well format tubes. Micronic offers also a wide range of manual and automated capping and decapping equipment. These devices enable significant productivity gains to be made in the opening and closing of multiple sample storage tubes. In addition, several sample management solutions are available that suit all throughput and budget needs.



Equipment service & warranty

Designed
in-house

Micronic Equipment Assembly Center

All Micronic equipment is designed and assembled in-house. We have well-trained personnel on hand to provide service on equipment. These services range from annual maintenance, installation support and customization, to repairs.

At Micronic, high quality and a high level of service are of paramount importance. By assembling equipment in-house, Micronic's equipment assembly personnel and engineers have the first-hand knowledge and skills necessary to perform services quickly and smoothly.



Micronic Warranty on Equipment





The Micronic products are designed and manufactured to the highest quality standards to deliver outstanding performance, ease of use and ease of installation. In case a user encounters any difficulties while installing or using the product, please let us know, we're glad to help.

Micronic warrants that its product are of satisfactory quality and conform to applicable EU legislation. If the product turns out to be defective, Micronic will arrange to repair or replace the product during the warranty period. The warranty period starts on the day of Micronic's invoice of the original product and ends after five (5) years with respect to Micronic Code Reading equipment and after one (1) year with respect to any other equipment.

The Micronic Warranty does not affect consumer statutory rights under applicable local laws, nor consumer rights against the seller arising from the purchase transaction. For more information about Micronic Warranty on equipment or about its applicability, please request the 'Micronic Warranty Statement'.

Service needed?

To obtain service please contact Micronic America / Asia / Europe or a local Micronic reseller.

	TUBE READER DT300	TUBE READER DT510	RACK READER DR505	RACK READER DR700	RACK READER DR710
	 Page 75	 Page 76	 Page 77	 Page 78	 Page 78
Basic Features					
Imaging technology	CIS	CMOS	CIS	CCD	CCD
Decode time	<1 second	<1 second	1 second	1 second	1 second
Scan time	<1 second	<1 second	5 seconds	7 seconds	7 seconds
Dimensions (mm)	150 x 40 x 40	90 x 80 x 95.4	265 x 186 x 70	309 x 230 x 87	309 x 230 x 87
Micronic Code Reader Software	n/a	n/a	Yes	Yes	Yes
Software compatibility					
Windows 11 and 10*	Yes	Yes	Yes	Yes	Yes
Connection	USB x 1	USB x 1	USB x 2	USB x 2	USB x 2
Output options					
Output text file	Yes	Yes	Yes	Yes	Yes
Configure output file	Yes	Yes	Yes	Yes	Yes
Export to Excel	Yes	Yes	Yes	Yes	Yes
ODBC Database push	n/a	n/a	Yes	Yes	Yes
User account independent	Yes	n/a	Yes	Yes	Yes
Network ready	n/a	n/a	Yes	Yes	Yes
TCP/IP Remote control	n/a	n/a	Yes	Yes	Yes
Tube / rack compatibility					
24-well format tube / rack	Yes	Yes	Yes	Yes	Yes
48-well format tube /rack	Yes	Yes	Yes	Yes	Yes
96-well format tube / rack	Yes	Yes	Yes	Yes	Yes
138-well format rack	Yes	Yes	No	Yes	Yes
Read all 2D Data-Matrix codes	Yes	Yes	Yes	Yes	Yes
Other features					
No tube, no code feature	n/a	n/a	Yes	Yes	Yes
Single tube reading	Yes	Yes	Yes	Yes	Yes
Rack templates	n/a	n/a	Yes	Yes	Yes
Anti-frost sytem	n/a	No	Yes	Yes	Yes
Robot gripper friendly	n/a	No	Yes	Yes	Yes
Linear barcode reading	Yes, tube & rack 1D code	Yes, tube & rack 1D code	Optional, 1D rack codes	Optional, 1D rack codes	Optional, 1D rack codes
Rack bottom ID (2D code) reading	n/a	Yes	Yes	Yes	Yes

* Please contact us for compatibility with other Windows versions.

RACK READER DR900



Page 79

CMOS
3 seconds
n/a
170 x 145 x 193.5
Yes

Yes
USB x 2

Yes
Yes
Yes
Yes
Yes
Yes
Yes

Yes
Yes
Yes
Yes
Yes

Yes
No
Yes
No
No

Optional, 1D rack codes
Yes

TUBE HANDLER HT500



Page 86

Basic Features
Capacity
Throughput
Compatibility
Dimensions (mm)

20 racks total
400 tubes per hour
96-well format tubes till 1.40ml
666 x 1153 x 604

Other features
Code reading
Linking between Rack ID and rack position
Loading pick list
Output file
Enclosed system

Yes, 2D codes and 1D codes
Yes, semi-automated
Via USB thumb drive
CSV-file
No

TUBE HANDLER HT700







Page 87

24 source racks & 3 target racks
550 tubes per hour
0.50ml - 1.40ml (96-well format)
566 x 907 x 950

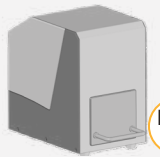
Yes, 2D codes and 1D codes
Yes, automated
Via USB thumb drive
CSV-file
Yes



	PUSH CAP CAPPER CP400	PUSH CAP CAPPER CP600/610	PUSH CAP DECAPPER CP620	SCREW CAP RECAPPER CS100	SCREW CAP RECAPPER CS500	SCREW CAP RECAPPER CS700
	 Page 79	 Page 80	 Page 81	 Page 82	 Page 83	 Page 85
Basic Features						
Equipment type	Capper	Capper	Decapper	Recapper	Recapper	Recapper
Push or Screw Caps	Push Caps	Push Caps	Screw Caps	Screw Caps	Screw Caps	Screw Caps
Cycle time (whole rack)*	n/a	7 seconds	8 seconds	n/a	60 seconds	30 seconds
Dimensions (mm)	262 x 185 x 164	374 x 209 x 324	531 x 258 x 366	130 x 19	178 x 161 x 710	590 x 251 x 460
Adapters required	Yes	No	No	n/a	No	No
Voltage	n/a	115 - 230 V	115-230 V	n/a	115-230 V	115-230 V
Tube / rack compatibility						
24-well format tube / rack	No	No	No	Yes (CS120 model)	Yes (CS520 model)	Yes (CS720 model)
48-well format tube / rack	No	No	No	Yes (CS110 model)	Yes (CS510 model)	Yes (CS710 model)
96-well format tube / rack	Yes, up to 1.40ml	Yes, up to 1.40ml (CP600) up to 2.00ml (CP610)	Yes, up to 1.40ml	Yes (CS100 model)	Yes (CS500 model)	Yes CS700 model)
Other features						
Compatibility automated systems	n/a	Yes	Yes	n/a	Yes	Yes
Manual or automated system	Manual	Automated	Automated	Manual	Automated	Automated
Docking Station	n/a	n/a	n/a	n/a	Yes	n/a
Optional Tube Detection Sensor	n/a	n/a	n/a	n/a	n/a	Yes

* The cycle time can vary depending on the tube type used.



The Micronic Tube Reader DT300 enables users to reliably read 1D and 2D tube and rack codes almost instantly. This small lightweight device is practical to carry around, easy-to-use and can read any 1D barcode or 2D Data-Matrix code on 24-, 48- and 96-well format tubes and racks. The DT300 offers convenient, high performance scanning anywhere you might need it.



Superior features

- Instantly reads 2D and 1D codes
- Compatible with iOS, Android and Windows and Bluetooth dongles attached to any laptop
- Storage of approximately 15.000 2D scans and 17.000 1D scans
- Personalized configuration with time, date, user, project name, and other useful data
- Reads directly into a LIMS system, Excel spreadsheet or notepad
- Long-lasting battery through 10-12 hours of continuous usage



REQUEST DEMO

Experience what the DT300 has to offer by requesting a demo. E-mail us at sales@micronic.com or call +1 484 480 3372 (Micronic America) / +65 85 028 878 (Micronic Asia) / +31 (0)320 277 099 (Micronic Europe).

Specifications

		Compatible with tubes from 0.30ml to 6.00ml
		Compatible with Micronic tubes and tubes from other brands
		Scan time is < 1 second
		150 x 40 x 40 mm / 5.91 x 1.57 x 1.57 inch
		80 grams / 0.17 lbs
		Via USB cable

Ordering information

More information about product numbers and ordering, see page 88.



VIEW PRODUCT ONLINE

The Micronic Tube Reader DT510 is high-speed code reading at its best. The DT510 is the most versatile single tube reader in the market - it reads 1D rack barcodes and 1D barcoded and 2D Data-Matrix coded tubes in less than a second. It is a plug-and-play reader that requires no software installation and is very easy to use.

Code reader



Superior features

- High-end sophisticated decoding engine
- Fully automated scan and decode feature
- No software installation required
- Scans and decodes 1D & 2D rack codes and 1D & 2D Data-Matrix coded tubes in less than a second
- Compatible with tubes in 96-, 48-, and 24-well format
- Small footprint
- Keyboard wedge functionality
- Correct code reads are indicated with a bleep
- USB connection (no power supply needed)
- Compatible with other suppliers of 1D and 2D barcoded tubes









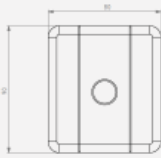

Plug and play device

LEAVE A REVIEW



Micronic highly appreciates your feedback. We are asking for your valuable opinion on our products and services on SelectScience®, an independent global scientific publisher. Your review helps us shape the future of our products and guide other scientists and laboratory professionals in their purchasing decisions.

Specifications

		Compatible with tubes from 0.30ml to 6.00ml
		Compatible with Micronic tubes and tubes from other brands
		Scan time is < 1 second
		90 x 80 x 95.4 mm / 3.54 x 3.15 x 3.76 inch
		321 grams / 0.7 lbs
		5VDC 0.3A

Ordering information

More information about product numbers and ordering, see page 88.



The Micronic Rack Reader DR505 reads whole racks filled with 2D Data-Matrix coded tubes quickly, cost-effective and with limited lab space. The compact reader is built for high throughput and automated systems. It enables a reliable interface with your sample organization.



Superior features

- Reads a whole rack (in 96-, 48-, or 24-well format) in less than 5 seconds and a single 96-well format tube in less than 2 seconds
- Anti-frost system which minimizes condensation of frozen samples on the scanner plate
- Scans and decodes 2D Data-Matrix coded tubes
- Small bench top solution
- Easy-to-use Code Reader Software (latest version)
- Outputs CSV-files (text)
- Compatible with most brands of 2D Data-Matrix coded tubes
- 5-year warranty
- Integration with LIMS systems

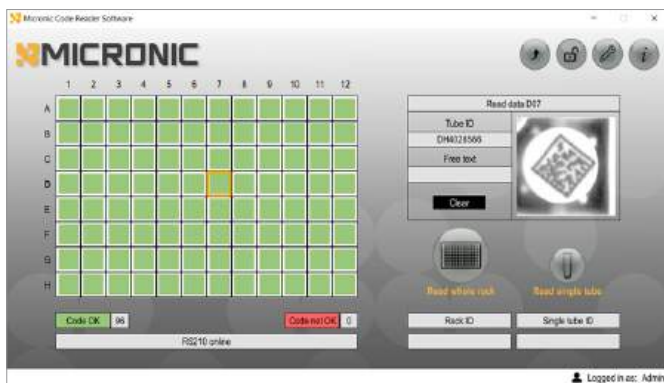

Additional options

- Integrated Micronic Side Barcode Reader for DR500 line

Specifications

		Compatible with tubes from 0.30ml to 6.00ml
		Compatible with Micronic tubes and tubes from other brands
		5 seconds (whole rack) / 2 seconds (single tube)
		265 x 186 x 70 mm / 10.4 x 7.3 x 2.8 inch
		3.4 kg / 7.5 lbs
		115 - 230 V

Ordering information

More information about product numbers and ordering, see page 88.



[VIEW PRODUCT ONLINE](#)

The high-end Micronic Rack Readers DR700 and DR710 read whole racks filled with 2D Data-Matrix coded tubes. The readers feature a CCD image sensor ensuring the highest accuracy 2D code reading. The DR710 has a uniquely designed active anti-frost system, which prevents the condensation of the scanning plate so that codes from frozen samples can be read.



Superior features







- CCD image sensor for high resolution image quality
- Active anti-frost system which prevents condensation of frozen samples on the scanner plate (DR710 model)
- Reads racks filled with tubes (in 138-, 96-, 48-, or 24-well format) in less than 7 seconds
- Reads a single tube (in 96-, 48-, or 24-well format) in less than 2 seconds
- Scans and decodes 2D Data-Matrix codes
- Small bench top solution
- Easy-to-use Code Reader Software (latest version)
- Outputs CSV-files (text)
- Compatible with most brands of 2D Data-Matrix coded tubes
- 5-year warranty

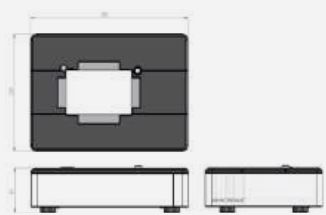

Additional options

- Integrated Micronic Side Barcode Reader for DR700 line

Specifications

		Compatible with tubes from 0.30ml to 6.00ml
		Compatible with Micronic tubes and tubes from other brands
		7 seconds (whole rack) / 2 seconds (single tube)
		309 x 230 x 87 mm / 12.2 x 9.1 x 3.4 inch
		5.1 kg / 11.2 lbs (estimated)
		115 - 230 V

Ordering information

More information about product numbers and ordering, see page 88.



The high speed Micronic Rack Reader DR900 read whole racks filled with 2D Data-Matrix coded tubes in 3 seconds. The readers feature a CMOS image sensor ensuring the highest accuracy 2D code reading. The Reader is camera-based with a 5 megapixel camera, ensuring fast and accurate code reading.

Code reader









Superior features

- CMOS image sensor for high resolution image quality
- 5 megapixel camera inside the reader, for fast and accurate code reading
- Reads racks filled with tubes (in 138-, 96-, 48-, or 24-well format) in less than 7 seconds
- Reads and decodes 2D Data-Matrix codes
- Small bench top solution
- Easy-to-use Code Reader Software (latest version)
- Outputs CSV-files (text)
- Compatible with most brands of 2D Data-Matrix coded tubes
- 5-year warranty

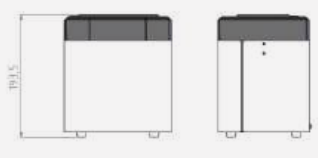
Additional options

- Integrated Micronic Side Barcode Reader for DR900 line

Specifications

		Compatible with tubes from 0.30ml to 6.00ml
		Compatible with Micronic tubes and tubes from other brands
		3 seconds whole rack
		170 x 145 x 193.5 mm / 6.7 x 5.7 x 7.6 inch
		1.9 kg / 4.2 lbs (estimated)
		5 V (USB supply)

Ordering information

More information about product numbers and ordering, see page 88.



VIEW PRODUCT ONLINE

The Manual Micronic Push Cap Capper CP400 offers a cost effective way of applying uniform pressure to Push Caps in an entire 96 tubes rack in only a single action. Built to meet the varying needs of different users, the Push Cap Capper CP400 can seal full or partially full racks with the complete range of Micronic TPE or EVA style capmats, capbands and capclusters.









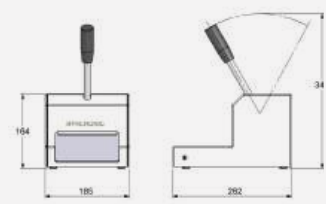

Superior features

- Caps tubes (up to 1.40ml) in all ANSI/SLAS format racks up to maximum height of 48.0mm
- Caps an entire 96-format rack in one single action with minimum force required
- Compact design and easy to use - no installation required
- Safe operation and even capping guaranteed
- Integrity of sample ensured
- Minimizes cross-contamination
- Works on full and partially-full racks
- Height adapters match customer's specifications
- Cost effective
- Robust and durable material
- Compatible with all Micronic push caps (TPE or EVA style capmats, capbands and capclusters)
- Compatible with other brands of tubes, caps, and racks

Additional options

- Adapters available for tubes from other brands

Specifications

		Compatible with tubes from 0.30ml to 1.40ml
		Compatible with Micronic tubes and tubes from other brands
		+/- 5 seconds (whole rack)
		262 x 185 x 164 mm / 10.4 x 7.3 x 2.8 inch
		7 kg / 15 lbs
		n/a

Ordering information

More information about product numbers and ordering, see page 88.



The Push Cap Cappers CP600 (up to 1.40ml) and CP610 (up to 2.00ml) can cap Micronic Push Caps on 96-format tubes in rack. The cappers are compatible with the following caps: TPE Capmats, Capbands, Capclusters and EVA Capmats. The cappers seal an entire rack of 96 tubes within approximately 7 seconds and have a guaranteed evenly capping result.



Superior features

- No adapters required
- Caps an entire rack of 96 tubes in an average of 7 seconds (depends on the tube height)
- Operates without any buttons
- Compact and robust design
- Controlled pressure system for an evenly capping result
- Works on full and partially full racks (minimum amount of 10 tubes)
- Compatible with the Micronic range of 96-well format tubes and racks
- Works with tube sizes up to 1.40ml (CP600) or with tube sizes up to 2.00ml (CP610)
- Also compatible with other brands of tubes and caps



“The capping equipment and TPE push caps have been super efficient and easy to use, I use them as often as I can. The reliability of the equipment has been great with continuous usage.”

- Bristol Myers Squibb

Specifications

		Compatible with tubes up to 2.00ml (CP610) / up to 1.40ml (CP600)
		Compatible with Micronic tubes and tubes from other brands
		7 seconds (whole rack)
		374 x 209 x 324 mm / 14.7 x 8.2 x 12.7 inch
		16 kg / 35 lbs
		115 - 230 V

Ordering information

More information about product numbers and ordering, see page 88.



VIEW PRODUCT ONLINE

With the ever-growing requirement for higher sample throughput in many laboratories the Micronic Push Cap Decapper CP620 enables significant productivity gains to be made in the opening of multiple sample storage tubes. The internal cap grippers are developed in such a way that cross-contamination is minimized.

Decapper



Superior features







- No adapters required
- Decaps 96 tubes in 8 seconds
- Simple and safe operation
- Friendly user interface for an easy selection of tube sizes
- CE-approved and conforms to UL
- Operates stand-alone or in a fully automated environment
- Minimum cross-contamination
- Remote control via RS232
- Compatible with the Micronic range of 96-format internal thread tube (up to 1.40ml)
- Also compatible with other brands of tubes and caps



NEED ASSISTANCE?

We're committed to providing fast, customer focused support on all your technical enquiries. E-mail us at helpdesk@micronic.com or call +1 484 480 3372 (Micronic America) / +65 85 028 878 (Micronic Asia) / + 31 (0)320 277 099 (Micronic Europe), we'll be right there with you.

Specifications

		Compatible with tubes up to 1.40ml
		Compatible with Micronic tubes and tubes from other brands
		10-15 seconds (whole rack)
		531 x 258 x 366 mm / 20.9 x 10.2 x 14.4 inch
		25 kg / 55 lbs
		115 - 230 V

Ordering information

More information about product numbers and ordering, see page 88.



The Micronic Screw Cap Recapper CS100 line is developed to improve the manual (de)capping of tubes. The manual recappers are available for 96- (CS100 model), 48- (CS110 model) or 24- (CS120 model) well format tubes. The cost-effective tools are set to a precise torque value and stop turning when a perfect seal is established, ensuring an optimal sealing performance.

Superior features

- Quick and easy to use
- Each screw cap is reproducibly tightened securely and uniformly
- Minimizes contamination
- Ergonomic lightweight solution for left and right handed use
- Set to a precise torque value and stops turning when the perfect seal is established
- No need for battery recharging
- Made from stainless steel
- Models available for Micronic 96-, 48- and 24-well format Screw Caps, as well as caps from other brands



Specifications

		Compatible with tubes from 0.30ml to 6.00ml
		Compatible with Micronic tubes and tubes from other brands
		130 x 19 mm / 5.12 x 0.75 inch
		0.095 kg / 0.21 lbs

Ordering information

More information about product numbers and ordering, see page 88-89.



VIEW PRODUCT ONLINE

The Micronic Screw Cap Recapper CS500 line is developed in conjunction with several leading laboratories. The handheld device offers users the ability to cap, decap or recap a row of 8 (CS500 model), 6 (CS510 model) or 4 (CS520 model) tubes in less than 5 seconds - 10 times faster than by hand! Thereby, minimizing sample evaporation and significantly improving productivity.

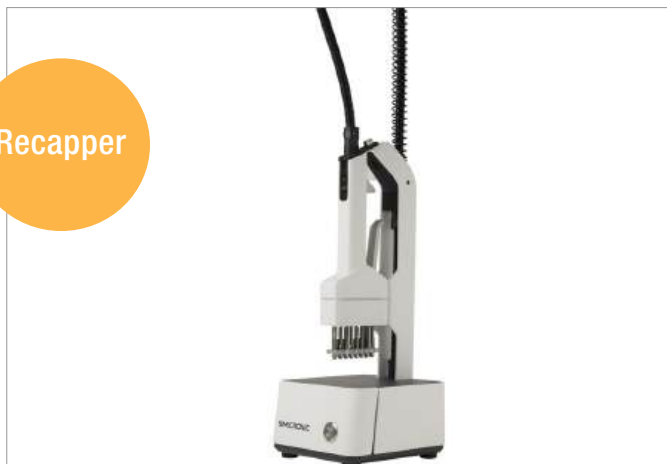
Superior features







- Highly durable solution to cap, decap or recap a row of 8, 6 or 4 tubes at once
- Each screw cap is reproducibly tightened securely and uniformly
- Caps a row of 8 tubes in 5 seconds and a whole rack of 96 tubes in only 1 minute - 10 times faster than by hand!
- Minimizes contamination
- Easy positioning of screw caps above the tubes
- Ergonomic lightweight solution for left and right handed use
- Caps can be easily discarded using the large ejection handle
- Very small footprint for bench top use
- No need for battery recharging
- Models available for Micronic 96-, 48- and 24-well format Screw Caps, as well as caps from other brands

Additional options

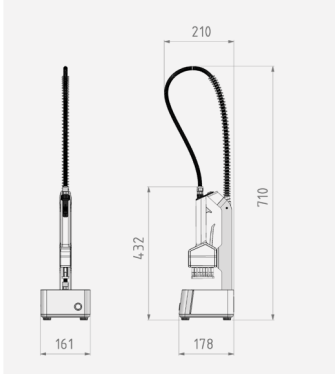
- Docking station for CS500 line



Specifications

		Compatible with tubes from 0.30ml to 6.00ml
		Compatible with Micronic tubes and tubes from other brands
		<5 seconds (per row)
		178 x 161 x 710 mm / 7.01 x 6.34 x 27.95 inch
		5.5 kg / 12.0 lbs
		115 - 230 V

Ordering information

More information about product numbers and ordering, see page 89.



The Micronic Docking Station for CS500 semi-automated recapping systems is a compact, benchtop unit designed for efficient tube recapping in labs with medium throughput. The combination can be used to recap 96-, 48- and 24-well format sample storage tubes. The Docking Station offers the consistency of an automated recapping system, but at a much lower cost.

Docking station



Superior features







- Consistent capping and decapping action is assured
- User friendly
- Improves ergonomics
- Small footprint for bench top use
- Caps, decaps or recaps a row of 8-6-4 tubes in 5 seconds
- Each screw cap is reproducibly tightened securely and uniformly
- Compatible with the complete line of Micronic CS500 Recappers
- Compatible with ANSI / SLAS standard format storage racks from Micronic and other brands

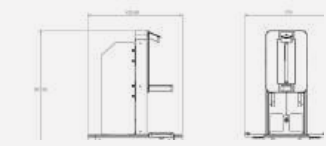

COMBI-DEAL

Benefit from an attractive combi-deal when purchasing the Docking Station and Recapper together. Inquire now! E-mail us at sales@micronic.com or call +1 484 480 3372 (Micronic America) / +65 85 028 878 (Micronic Asia) / +31 (0)320 277 099 (Micronic Europe), we'll be right there with you.

Specifications

		Compatible with tubes from 0.30ml to 6.00ml
		Compatible with ANSI / SLAS standard format storage racks
		<5 seconds (per row)
		420.5 x 370 x 503.5 mm / 16.56 x 14.57 x 19.82 inch
		9 kg / 19.8 lbs

Ordering information

More information about product numbers and ordering, see page 89.



VIEW PRODUCT ONLINE

The Micronic Screw Cap Recapper CS700 line offers users the ability to cap, decap or recap 96 (model CS700), 48 (model CS710) or 24 (model CS720) tubes with Screw Caps in a single action. Designed to improve efficiency, the Micronic Screw Cap Recapper can be used as a stand-alone instrument or be simply integrated into a fully automated laboratory environment.



Superior features







- Extremely durable design for reliable operation
- Caps, decaps or recaps 96 Screw Cap tubes at once in less than 30 seconds
- Compatible with the complete Micronic range of 96-well format tubes (up to 2.00ml)
- Precise torque value for optimal sealing quality
- No adapters required
- Easy-to-use graphical touch screen interface
- Operates stand-alone or in a fully automated environment
- Sensor cap detection that enhances process safety for automation (optional)
- Ethernet connection provides many possibilities for different communication protocols
- Models available for Micronic 96-, 48-, and 24-well format Screw Caps, as well as caps from other brands

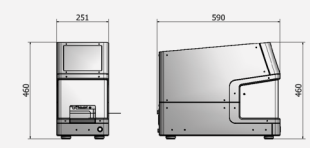

“It’s a very smoothly running, easy to use and silent device. I also think it is a great benefit that the Screw Cap Recapper is contamination-free.”

- Radboud UMC

Specifications

		Compatible with tubes from 0.30ml to 6.00ml
		Compatible with Micronic tubes and tubes from other brands
		30 seconds (whole rack)
		590 x 251 x 460 mm / 23.2 x 9.9 x 18.1 inch
		38 kg / 84 lbs
		115 - 230 V

Ordering information

More information about product numbers and ordering, see page 89.



The Tube Handler HT500 is an affordable sample management system that sorts your valuable liquid and solid samples. The device can be used to pick specific specimens from a large group of samples. The HT500 has a total rack capacity of 20 racks, specify at least one target rack and one source rack per run.



Tube Handler

Superior features

- Total rack capacity: 20
- Fast pick & place operation of approx. 400 tubes per hour
- 2D code reading and 1D code reading (source and target rack)
- Easy to navigate and intuitive interface
- Semi-automatic linking between rack ID and rack position
- Loading CSV-file pick list from USB thumb drive
- Output CSV-file of rack content
- Separate safety stop ensures sample/product protection
- Compatible with Micronic racks (ANSI/SLAS standard)
- Compatible with 0.30ml, 0.40ml, 0.50ml, 0.75ml, 0.80ml, 1.10ml and 1.40ml Micronic tubes



Additional options

- Contact us for compatibility with other brands

Specifications

		Compatible with tubes from 0.30ml to 1.40ml
		Compatible with Micronic tubes in 96-well format
		Sort tubes from a total capacity of 20 racks
		666 x 1153 x 604 mm / 24.88 x 23.78 x 23.74 inch
		60 kg / 132 lbs
		230 V

Ordering information

More information about product numbers and ordering, see page 89.



[VIEW PRODUCT ONLINE](#)

The space efficient Tube Handler HT700 provides an easy, automated and reliable solution to sort sample storage tubes. The device can be used to pick specific specimens from a large group of samples. Automated sample identification and collection reduces human errors and reliefs researchers from repetitive manual labour.



Tube Handler

Superior features







- Minimal footprint increase with doubling of capacity
- Source rack capacity: 24
- Target rack capacity: 1-3
- Fast pick & place operation of approx. 550 tubes per hour
- Picking and 2D code reading a high number of samples with a space efficient design
- 2D code reading and 1D code reading (source and target rack)
- Easy to navigate and intuitive interface
- Automatic linking between rack ID and rack position
- Loading CSV-file pick list from USB thumb drive
- Grouping field in pick list for sample clustering in target rack
- Output CSV-file of rack content
- Enclosed system for operator safety
- Seperate safety stop ensures sample/product protection
- Compatible with Micronic racks (ANSI/SLAS standard)
- Compatible with 0.30ml, 0.40ml, 0.50ml, 0.75ml, 0.80ml, 1.10ml and 1.40ml Micronic tubes

Additional options

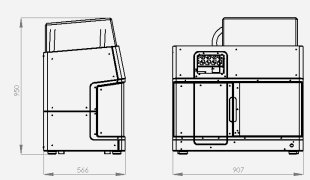
- Contact us for compatibility with other brands



Specifications

		Compatible with tubes from 0.30ml to 1.40ml
		Compatible with Micronic tubes in 96-well format
		Sort tubes from 24 source racks into 1-3 target racks
		566 x 907 x 950 mm / 223 x 358 x 374 inch
		120 kg / 265 lbs
		230 V

Ordering information

More information about product numbers and ordering, see page 89.



TUBE readers

from page 75-76

Catalog number	Description	Case Size
Single Tube Readers		
MP55127	Micronic Tube Reader DT300	1 unit
MP55128	Micronic Tube Reader DT510	1 unit

RACK readers

from page 77-78

Catalog number	Description	Case Size
Single Rack Readers and Accessories		
MP35221	Micronic Rack Reader DR505	1 unit
MP35230	Micronic Rack Reader DR700	1 unit
MP35232	Micronic Rack Reader DR710	1 unit
MP35231	Micronic Rack Reader DR900	1 unit
MP35240	Micronic Side Barcode Reader for DR500 line	1 unit
MP35250	Micronic Side Barcode Reader for DR700 line	1 unit
MP35270	Micronic Side Barcode Reader for DR900 line	1 unit
MP35261	Micronic Rack Reader DR505 & Side Barcode Reader Pack	1 unit
MP35262	Micronic Rack Reader DR700 & Side Barcode Reader Pack	1 unit
MP35263	Micronic Rack Reader DR710 & Side Barcode Reader Pack	1 unit
MP35264	Micronic Rack Reader DR900 & Side Barcode Reader Pack	1 unit

MANUAL push cap cappers

from page 79

Catalog number	Description	Case Size
Manual Push Cap Cappers		
MP35050	Micronic Push Cap Capper CP400 (including 1 adapter of your choice)	1 unit
MP35054	Micronic 0.50ml Adapter for Push Cap Capper CP400	1 unit
MP35053	Micronic 0.75ml Adapter for Push Cap Capper CP400	1 unit
MP35052	Micronic 1.10ml Adapter for Push Cap Capper CP400	1 unit
MP35051	Micronic 1.40ml Adapter for Push Cap Capper CP400	1 unit

ELECTRIC push cap (de)cappers

from page 80-81

Catalog number	Description	Case Size
Electric Push Cap Cappers		
MP35020	Micronic Push Cap Capper CP600 for tube sizes up to 1.40ml in 96-format	1 unit
MP35021	Micronic Push Cap Capper CP610 for tube sizes up to 2.00ml in 96-format	1 unit
Electric Push Cap Decappers		
MP35000	Micronic Push Cap Decapper CP620 for tube sizes up to 1.40ml in 96-format	1 unit

SCREW CAP recappers*

from page 82-85

Catalog number	Description	Case Size
Screw Cap Recappers CS100 Line		
MP35480	Micronic Screw Cap Recapper CS100 for Micronic Screw Caps (TRE)	1 piece
MP35481	Micronic Screw Cap Recapper CS100 for Micronic Screw Caps (TRI)	1 piece
MP35482	Micronic Screw Cap Recapper CS100 for Micronic Low Profile Screw Caps (TRI)	1 piece
MP35490	Micronic Screw Cap Recapper CS110 for Micronic Screw Caps (TRE)	1 piece
MP35491	Micronic Screw Cap Recapper CS110 for Micronic Screw Caps (TRI)	1 piece
MP35492	Micronic Screw Cap Recapper CS120 for Micronic Screw Caps (TRE)	1 piece
MP35493	Micronic Screw Cap Recapper CS120 for Micronic Screw Caps (TRI)	1 piece
Screw Cap Recappers CS500 Line		
MP35420	Micronic Screw Cap Recapper CS500 for Micronic Screw Caps (TRE)	1 unit
MP35421	Micronic Screw Cap Recapper CS500 for Micronic Screw Caps (TRI)	1 unit
MP35422	Micronic Screw Cap Recapper CS500 for Micronic Low Profile Screw Caps (TRI)	1 unit
MP35440	Micronic Screw Cap Recapper CS510 for Micronic Screw Caps (TRE)	1 unit
MP35441	Micronic Screw Cap Recapper CS510 for Micronic Screw Caps (TRI)	1 unit
MP35445	Micronic Screw Cap Recapper CS520 for Micronic Screw Caps (TRE)	1 unit
MP35446	Micronic Screw Cap Recapper CS520 for Micronic Screw Caps (TRI)	1 unit
Docking Station		
MP35495	Micronic Docking Station for CS500 line	1 unit
MP35496C	Micronic Screw Cap Recapper for CS500 & Docking Station Pack	1 unit
Screw Cap Recappers CS700 Line		
MP35462	Micronic Screw Cap Recapper CS700 TDS for Micronic Screw Caps (TRE)	1 unit
MP35463	Micronic Screw Cap Recapper CS700 TDS for Micronic Screw Caps IG (TRE)	1 unit
MP35464	Micronic Screw Cap Recapper CS700 TDS for Micronic Screw Caps (TRI)	1 unit
MP35465	Micronic Screw Cap Recapper CS700 TDS for Micronic Low Profile Screw Caps (TRI)	1 unit
MP35472	Micronic Screw Cap Recapper CS710 TDS for Micronic Screw Caps (TRE)	1 unit
MP35473	Micronic Screw Cap Recapper CS710 TDS for Micronic Screw Caps (TRI)	1 unit
MP35477	Micronic Screw Cap Recapper CS720 TDS for Micronic Screw Caps (TRE)	1 unit
MP35478	Micronic Screw Cap Recapper CS720 TDS for Micronic Screw Caps (TRI)	1 unit
Tube Detection Sensor Option		
MP35090	Tube Detection Sensor Option for Micronic Screw Cap Recapper CS700-series	1 unit
Cap Carriers		
MP51500	Micronic disposable cap carrier for 96-well format Screw Caps (empty)	4 x 10 carriers
MP51501	Micronic disposable cap carrier for 48-well format Screw Caps (empty)	4 x 10 carriers
MP51502	Micronic disposable cap carrier for 24-well format Screw Caps (empty)	4 x 10 carriers

* Other item numbers are available for the Screw Cap Recappers compatible with other brands. Screw Cap Recappers in the CS700 line are supplied with 5 cap carriers and are standard configured for 2 tube types with the same cap color.

TUBE handlers

from page 86-87

Catalog number	Description	Case Size
Tube Handlers		
MP35510	Micronic Tube Handler HT500 (pick and place + 2D reading)	1 unit
MP35500	Micronic Tube Handler HT700 (pick and place + 2D reading)	1 unit
Manual tube picking tool		
MP54007	Tube Selector Tool	5 pieces



Serving
scientists
since 1984

Certified
Class 7 clean
room manu-
facturing

SAMPLE STORAGE STARTER PACKS

Everything you need to get started with using 2D coded tubes to track and store your valuable samples. Micronic offers a fully traceable storage solution at a low cost. Buying the starter pack can save you up to 20% compared to buying the products individually. Since the amount of stored samples differs laboratory by laboratory, Micronic offers starter packs in a range of sizes: basic, standard, advanced, premium and premium+.

Everything
you need



Sample storage with Micronic



Collect samples

Micronic products are essential during your sample storage process. When a liquid sample is obtained, it is often temporarily stored in a larger tube, like vacuum containers. For long-term storage, the sample is transferred from the larger tube into several Micronic sample storage tubes.



Close sample storage tubes

To securely close your sample storage tubes for long-term storage in -80°C , the TPE Capclusters from Micronic are an ideal and economical solution. Place a TPE Capcluster on the tubes in a 96-well format rack and the Micronic Push Cap Capper CP600 closes all 96 tubes in only 7 seconds! Remove the black foil to leave the tubes individually capped.



Scan tube codes

The Micronic Rack Reader reads the 2D Data-Matrix codes of sample storage tubes and the 1D barcodes of sample storage racks in just 5 seconds. The intuitive user interface of the Micronic Code Reader Software is designed for maximum functionality and enables full sample traceability.



Add samples to your database

Micronic Rack Readers are the link between your Sample Management Software and every individual sample. To make sure that the Micronic sample storage solution works with Sample Management Software we have extensively tested our readers with a wide range of Software Solutions available on the market.



Place samples in allocated freezer

After the sample data has been saved, the rack cover can be placed on the rack. The samples are now ready to be stored at the allocated freezer position.

	SAMPLE STORAGE STARTER PACK BASIC	SAMPLE STORAGE STARTER PACK STANDARD
<p>STARTER PACKS WITH SCREW CAPS</p> <p>10 racks filled with 2D coded tubes (internal and external thread) 40 racks filled with 2D coded tubes (internal and external thread) Screw Caps in Grey to cap 10 racks with tubes Screw Caps in Grey to cap 40 racks with tubes Micronic Tube Reader DT510 Micronic Rack Reader DR505 Micronic Side Barcode Reader for DR500 line Micronic Tube Reader DT300 Micronic Screw Cap Recapper CS500 Manual decapping tools</p>	 <p>Yes (0.75ml / 1.40ml)</p> <p>No</p> <p>Yes</p> <p>No</p> <p>Yes</p> <p>No</p> <p>No</p> <p>Yes</p> <p>No</p> <p>No</p> <p>Yes</p> <p>No</p> <p>Yes</p>	 <p>Yes (0.75ml / 1.40ml)</p> <p>No</p> <p>Yes</p> <p>No</p> <p>No</p> <p>Yes</p> <p>No</p> <p>No</p> <p>No</p> <p>No</p> <p>No</p> <p>Yes</p> <p>No</p> <p>No</p> <p>Yes</p> <p>Yes</p>
<p>STARTER PACKS WITH PUSH CAPS</p> <p>10 racks filled with 2D coded tubes (internal thread) 40 racks filled with 2D coded tubes (internal thread) TPE Caps in Grey to cap 10 racks with tubes TPE Caps in Grey to cap 40 racks with tubes Micronic Tube Reader DT510 Micronic Rack Reader DR700 Micronic Rack Reader DR505 Micronic Side Barcode Reader for DR700 line Micronic Tube Reader DT300 Micronic Push Cap Capper CP400 Micronic Push Cap Capper CP600 Manual decapper-1 Manual decapper-8</p>	 <p>Yes (0.75ml / 1.40ml)</p> <p>No</p> <p>Yes</p> <p>No</p> <p>Yes</p> <p>No</p> <p>No</p> <p>No</p> <p>No</p> <p>Yes</p> <p>No</p> <p>No</p> <p>No</p> <p>Yes</p> <p>No</p> <p>Yes</p> <p>Yes</p>	 <p>Yes (0.75ml / 1.40ml)</p> <p>No</p> <p>Yes</p> <p>No</p> <p>No</p> <p>Yes</p> <p>No</p> <p>No</p> <p>No</p> <p>No</p> <p>No</p> <p>No</p> <p>No</p> <p>No</p> <p>Yes</p> <p>No</p> <p>Yes</p> <p>Yes</p>

SAMPLE STORAGE STARTER PACK ADVANCED	SAMPLE STORAGE STARTER PACK PREMIUM	SAMPLE STORAGE STARTER PACK PREMIUM+
---	--	---

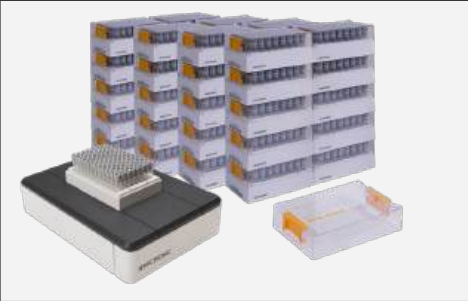

NOT AVAILABLE

No
Yes (1.00ml / 3.00ml / 3.50ml / 4.00ml)
No
Yes
No
Yes
Yes
No
No
No

Ideal for tissue storage

No
Yes (0.75ml / 1.40ml)
No
Yes
No
Yes
No
No
Yes
Yes

n/a
n/a
n/a
n/a
n/a
n/a
n/a
n/a
n/a

NOT AVAILABLE



n/a
n/a
n/a
n/a
n/a
n/a
n/a
n/a
n/a
n/a
n/a
n/a
n/a

No
Yes (0.75ml / 1.40ml)
No
Yes
No
No
Yes
No
No
Yes
No
Yes
Yes

No
Yes (0.75ml / 1.40ml)
No
Yes
No
Yes
No
Yes
No
No
Yes
Yes
Yes

INNOVATION AT MICRONIC

Custom projects

Industry leaders since 1984, Micronic serves scientists with sample storage and automation solutions. At Micronic, advancing scientific research to enhance quality of life is our corporate goal and to achieve this we make innovation and quality a priority. We engage in various innovative processes within our organization, like product development and customer focused lean manufacturing systems, in order to create new and improved products, solutions and services that provide radically better customer experiences. Our premium labware and precision engineered equipment is developed and manufactured in-house. This core competence gives us the opportunity to offer top-of-the-line products, delivering exceptional quality, reliability and durability. Above all, we stand behind our solutions and are confident that you will too.



Activities

Research & Development

The primary goal of our Research & Development (R&D) department is to develop new products, and to optimize existing ones. Another fundamental task of the team is to discover and create new knowledge about scientific and technological topics for the purpose of uncovering and enabling development of valuable new products, processes and services. At Micronic, we utilize a technology driven system in which R&D is directed towards developing those products, indicated by means of market research, that will meet an unmet need. By developing and manufacturing our products in-house, we have all first-hand high-tech manufacturing and R&D knowledge necessary to quickly adapt to developments in the market.

Custom projects

To help you find the best solutions for your sample storage needs, we are open to OEM developments and customer specific requests. If you have any suggestions about new or improved sample storage products, please contact us at sales@micronic.com. Micronic can offer you highly/academically trained personnel, knowledge in materials and injection mold development, technical and electrical knowledge, and a large network of suppliers. Our R&D department has also access to the following facilities: 3D CAD engineering, printing/plotting machines, a test facility with injection molding machines, a technical department for prototyping and modifications, and a laboratory testing facility.

Quality commitment

Manufactured following industry leading strict tolerances, the precision and tube-to-tube consistency of Micronic labware optimizes the compatibility with automated sample handling equipment. The materials and auxiliary agents used to manufacture our sample storage labware are FDA compliant and are selected on quality and the highest purity levels. In addition to our high manufacturing and material standards, we also engage in extensive product testing. When new or improved products are developed, they undergo several tests during the process to fine-tune the product and to create the most optimal solution for



specific customer applications. A wide range of tests are conducted at our laboratory testing facility, examples are: freeze-thaw cycles, protein binding tests, durability tests, evaporation/sealing tests, ultra-low temperature resistance tests, code readability tests and code scratch tests. Please be aware that Micronic takes great care to test its products in several usage conditions. However, as it is not possible to cover all applications, we highly recommend customers to test the products also within their own application before usage. If you need any assistance in performing these application tests, our technical support team is very happy to help.

Dedication to the environment

Our corporate goal extends to our commitment to safeguarding the natural environment for future generations. We have implemented environmental activities into our daily operations, and continuously work toward goals to increase efficiencies and reduce waste. In addition, Micronic constantly strives to utilize and develop solutions that minimize the impact on the environment – whether it is an energy efficient injection molding machine, plastic recycling, waste sorting, eco-friendly packaging or high-density products that promote efficiency at our customers' sites. Micronic takes further responsibility with respect to the environment by its internal environmental management system which is certified by Lloyd's Register Quality Assurance (ISO 14001). We are committed to comply with and where possible, considerably exceed all applicable laws and regulations related to environmental protection.

ACT.
The Environmental Impact Factor Label

EU

Micronic 1.40ml 2D Data-Matrix coded Screw Cap tubes U-bottom precapped with Grey Screw Cap in 96-4 Rack with high cover (Barcoded A1-F1 side)

Lafayette, Netherlands
100% recycled paper

Environmental Impact Scale
Increasing Environmental Impact

Manufacturing

Product Content	10.0
Packaging Content	1.0

User Impact

Energy Consumption (kWh/kg)	N/A
Water Consumption (liters/kg)	N/A
Product Lifetime	1.0

End of Life

Packaging	4.0
Product	8.8

Environmental Impact Factor: 32.8

Label Valid Through: June 2023

act.mygreenlab.org

ACT.
The Environmental Impact Factor Label

EU

Micronic 4.00ml 2D Data-Matrix coded Screw Cap tubes with External Thread Flat bottom precapped with Grey Screw Cap in 48-4 Rack with high cover (Barcoded A1-F1 side)

Lafayette, Netherlands
100% recycled paper

Environmental Impact Scale
Increasing Environmental Impact

Manufacturing

Product Content	10.0
Packaging Content	1.0

User Impact

Energy Consumption (kWh/kg)	N/A
Water Consumption (liters/kg)	N/A
Product Lifetime	1.0

End of Life

Packaging	4.0
Product	8.8

Environmental Impact Factor: 32.8

Label Valid Through: June 2023

act.mygreenlab.org

AVAILABLE IN MARCH

The ACT label is the first environmental impact factor label for laboratory products, developed by the non-profit organization My Green Lab. Micronic participates in this great program so that purchasers can make informed decisions about a product's environmental impact and to promote sustainability in the laboratory. At the moment we are in the process of a new ACT Label, this will be available from March 2024 on forward. We will share more information at that time.

To the best of our knowledge, the information contained herein is accurate and reliable. However, Micronic does not make any express or implied representation or warranty as to the accuracy or completeness of the information. It is the user's responsibility to inspect and test the Micronic products in order to satisfy itself as to the suitability of the products for its particular purpose. The user is responsible for the appropriate, safe and legal use, processing and handling of the Micronic products.

WHERE TO BUY

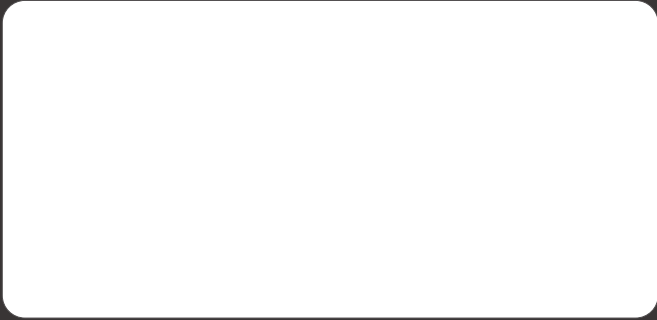

Micronic America

(US, Canada and Latin America)

Tel: +1 484 480 3372

Micronic Asia

(Asia and Pacific)

Tel: +65 85 028 878

Micronic Europe

(Europe, Middle-East and Africa)

Tel: +31 (0)320 277070

E-mail: sales@micronic.com

www.micronic.com

PD802315