

## Thermo Scientific Solid Phase Guide

- Solid Phase formats and surfaces
- Parameters affecting coating
- Assay conditions for ELISA
- Immobilization of DNA

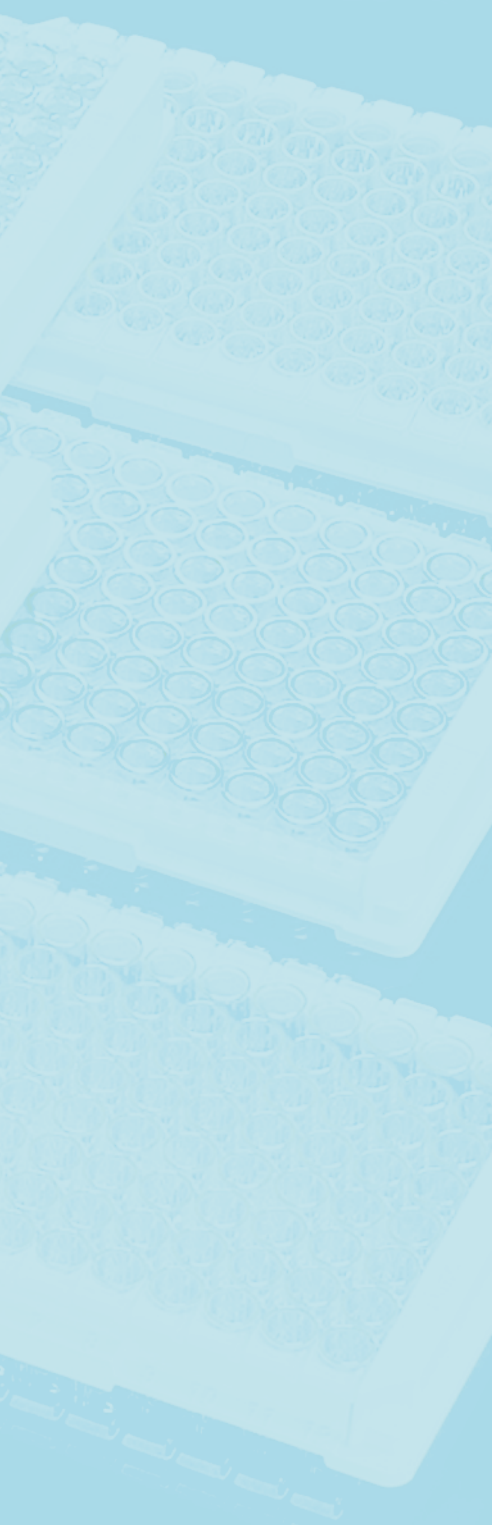
# an introduction to solid phase techniques

# Surface Matters



# Table of Contents

<b>Solid Phase Techniques .....</b>	<b>4</b>
Solid Phase Formats .....	4
Choice of Surface.....	5
The Coating .....	10
The Assay.....	12
Detection Systems.....	13
Quick guide to the optimization of an ELISA .....	16
Troubleshooting.....	18
<b>Frequently Asked Questions (FAQs).....</b>	<b>20</b>
<b>Immobilization of DNA.....</b>	<b>24</b>
<b>Glossary .....</b>	<b>28</b>
<b>Technical information index .....</b>	<b>30</b>
General .....	30
Passive Adsorption .....	30
Covalent Binding .....	31
Affinity Capture.....	31
<b>Appendix index .....</b>	<b>156</b>
Pipetting/dispensing .....	157
Washing procedures.....	159
Readers.....	161
Capture, pre- and post-capture reagents .....	163
Hybridization Detection of PCR Products .....	168
Common reagent recipes.....	170



# Solid Phase Techniques

## Solid Phase Formats

---

The 96 well format is the most common and is found either as whole plates or modules of 8, 12 or 16 wells. Also, separate use of individual wells is possible with Thermo Scientific Nunc BreakApart and LockWell modules. Plates with 384 and 1536 wells are available.

A number of well shapes are also available, flat bottoms, round bottoms, and C-wells which were devised as a compromise between round and flat wells in order to improve the washing without losing the optical advantage of the flat bottom. There is also the option of Thermo Scientific Nunc StarWell plates which allow a larger surface area to be coated thereby increasing the sensitivity and lowering the assay time. Thermo Scientific Nunc DeepWell plates are also available for a number of specialist applications.

Immunoassays can also be done in tubes. This allows flexibility in number of tests performed and allows a larger assay volume to be used. Handling is not as easy as when using well plates, but it is possible to use tubes for enzyme-linked immuno-sorbent assay (ELISA), immuno-radiometric assay (IRMA) and radio-immunoassay (RIA). Reading is slower than for ELISA photometry, but tubes are amenable for use in scintillation counters when doing RIA work. It is possible to increase sensitivity in tube assays by using Thermo Scientific Nunc StarTube vials, which have fins in the bottom to increase the surface available for coating.

Another option is offered for special adaptations which provides even greater choice and flexibility when designing an assay. The Thermo Scientific Nunc Immuno Stick tubes which allows qualitative and semi-quantitative assays to be done in the field. The system is capable of measuring two analytes simultaneously and includes both positive and negative controls on the same stick. The details of such a procedure are given in Thermo Scientific Nunc Bulletin No. 7b - 'Thermo Scientific Nunc Immuno Stick Methods'.

The transferable solid phase system (TSP) is another useful option which consists of a 96 well format lid with 96 pins which fits into a normal 96 well flat bottom plate. Since the surface area of the pin is approximately half that of a well, the sensitivity is correspondingly reduced, but when the system is optimized it can give results comparable to the larger scale ones.

The many advantages of the TSP system include speed, ease of use, minimal number of pipetting steps, and therefore less variability due to in-built error. The reactions always start simultaneously when the pins are immersed in the reagents, and a stop reaction is unnecessary as the removal of the pins takes the enzyme out of contact with the substrate immediately. The one-way fit of the TSP into the tray means that there is no risk of cross contamination between steps and pre-coating and storage of the system is possible. The system is usable for both IRMA and ELISA.

It is also possible to immobilize the solid phase on various types of beads, which can be separated from the liquid phase by centrifugation or by using a magnet. Beads provide a very large surface for coating, which means, in principle, that a

lower limit of detection can be reached. Optimizing the assay when using beads may be difficult, but can result in a very sensitive assay. Beads allow a great flexibility, both in terms of assay volume and in the number of tests performed at any given time. It is important to note that extreme care must be taken when pipetting the beads, as large errors can result from a small pipetting error due to the large surface area of the beads, and to the fact that the beads are constantly settling during the handling process. It should also be noted that the background can be difficult to control when using beads. In general, the use of beads for ordinary assays can create many problems which in many cases outweigh the gains.

# Choice of Surface

Whatever the format chosen, there are a number of choices to be made about the best type of surface for the application. The choice will depend on the assay component to be immobilized.

## Surfaces for passive adsorption

Passive surfaces have a broad range of applications as they can bind a variety of biomolecules, based on multiple weak molecular interactions forming a stable bond. Passive binding is therefore primarily suited for the immobilization of medium to large sized molecules, such as antibodies, which are capable of establishing several contact points. The exact molecular interaction sites are dependent on the specific matching of the biomolecule's properties with the polymer surface. A large variety of biomolecules can be stably immobilized on passive surfaces with good residual activity.

The family of Thermo Scientific passive surfaces vary in their degree of hydrophilicity and are organized into four different sub-groups: hydrophobic, slightly hydrophilic, hydrophilic, and very hydrophilic. A hydrophobic surface functions predominately via hydrophobic binding. With the increased hydrophilicity the incorporation of oxygen containing functional groups, electrostatic interactions can play a greater role in binding, thus influencing which types of biomolecules will bind strongly to the surface.

### Hydrophobic

These surfaces are typically used for the adsorption of hydrophobic molecules such as lipid rich biomolecules.

### Slightly hydrophilic

The slight hydrophilicity of these plates enhances their ability to bind a diverse range of biomolecules, including glycoproteins, serum containing samples and amphoteric molecules such as lipopolysaccharides. With these plates non-specific adsorption of serum containing samples are reduced, and this will improve the signal-to-noise (S/N) ratio and consequently, sensitivity levels.

### Hydrophilic

Optimized to bind high amounts of IgG (polyclonal), these plates are ideal for antibody sandwich assays (e.g. ELISAs). In addition, they show increased binding of many other proteins and biomolecules that possess hydrophilic/hydrophobic characteristics.

### Very hydrophilic

The most hydrophilic in our portfolio will bind many hydrophilic proteins with a high affinity to these plates. Binding does, however, tend to be more pH sensitive.

Table 1, Table 2 and Fig. 1 show the link between the surface and the affinity of the biomolecule.

**Table 1.**  
General guidelines for the selection of passive surfaces for the immobilization of particular biomolecules.

Passive Category	Surface	BIOMOLECULE			
		Immunoglobulins	Proteins (water soluble)	Proteins (less water soluble)	Glycans
<b>Hydrophobic</b>	PolySorp	Fair	Fair	Very Good	Low
	Immulon 1 B	Fair	Fair	Very Good	Low
	Universal Binding (UB)	Fair	Fair	Very Good	Low
	Microlite 1+	Fair	Fair	Very Good	Low
	Microfluor 1	Fair	Fair	Very Good	Low
<b>Slightly hydrophilic</b>	Immulon 2 HB	Good	Good	Good	Fair
	Microlite 2+	Good	Good	Good	Fair
	Microfluor 2	Good	Good	Good	Fair
	MediSorp	Good	Good	Good	Fair
<b>Hydrophilic</b>	MaxiSorp*	Very Good	Very Good	Fair	Good
	Immulon 4 HBX	Very Good	Very Good	Fair	Good
	Enhanced Binding (EB)	Very Good	Very Good	Fair	Good
<b>Very hydrophilic</b>	MultiSorp	Low	Good	Fair	Good

\* Optimized for IgG binding

## Surfaces for passive binding

Schematic representation of the types of biomacromolecules, which can be bound to the available modified surfaces. E.g. if a lipid is to be bound the hydrophobic surface Thermo Scientific Nunc PolySorp is most suitable. Based on the physicochemical characteristics of the biomolecule to be immobilized, a surface can be chosen which is appropriate for robust binding. As indicated in Fig. 1, Thermo Scientific Nunc MaxiSorp has the widest breadth applications as it is capable of binding the greatest range of molecules.

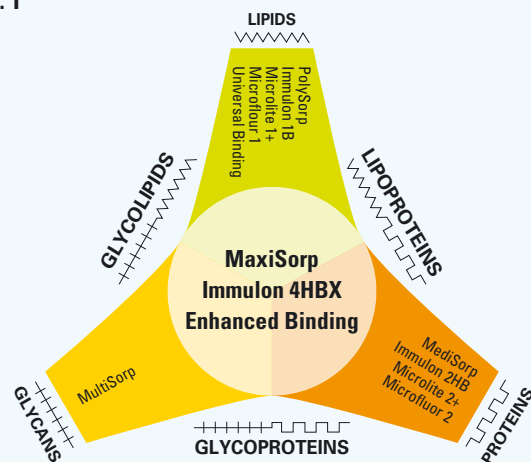
### Surface characteristics

- Adsorb larger biomolecules
- Different molecular orientations are possible
- A variety of surfaces are available for performance optimization

### Thermo Scientific Nunc TopYield

Nunc™ TopYield™ is made of polycarbonate and has a high affinity to immobilize proteins. Combined with a low background after blocking and compatibility with PCR thermocyclers makes the TopYield product suitable for liquid phase PCR or Immuno-PCR applications.

Fig. 1



Surfaces for passive binding

Table 2.

### Passive binding surfaces characteristics

Name	Base Polymer	Hydrophilicity	Binding Preference	Key Applications	Features
<ul style="list-style-type: none"> <li>○ PolySorp</li> <li>△ Immulon 1 B*</li> <li>△ Microlite 1+*</li> <li>△ Microfluor 1*</li> <li>△ Universal Binding (UB)</li> </ul>	Polystyrene	–	Biomolecules that have hydrophobic domains, e.g. lipids, lipoproteins, large proteins	Coated antigen ELISA, FIA, LIA	- Lower binding of immunoglobulins: approx. 200-250 ng IgG/cm <sup>2</sup>
<ul style="list-style-type: none"> <li>○ MediSorp*</li> <li>△ Immulon 2 HB*</li> <li>△ Microlite 2+*</li> <li>△ Microfluor 2*</li> </ul>	Polystyrene	+	Biomolecules with hydrophilic/hydrophobic properties, e.g. medium to large proteins such as albumin. Amphiphilic biomolecules such as LPS	Antibody sandwich ELISA, coated antigen ELISA	- Binds proteins - Moderate binding of immunoglobulin: MediSorp 500-600 ng IgG/cm <sup>2</sup> Immunon 2 HB 350-450 ng IgG/cm <sup>2</sup> - Lower non-specific binding with samples containing serum or plasma vs. high binding plates
<ul style="list-style-type: none"> <li>○ MaxiSorp*</li> <li>△ Immulon 4 HBX*</li> <li>△ Enhanced Binding (EB)*</li> </ul>	Polystyrene	++	Biomolecules with hydrophilic/hydrophobic properties. Designed for high binding of IgG. Also high binding for many other proteins and biomolecules that have hydrophilic/hydrophobic character	Antibody sandwich ELISA, FIA, LIA  Coated antigen ELISA, FIA, LIA	- Effectively binds a broad range of proteins and biomolecules (broadest range) - High binding plate. Immunoglobulin capacity: approx. 600-650 ng IgG/cm <sup>2</sup>
○ MultiSorp	Polystyrene	+++	Hydrophilic biomolecules, e.g. glycoproteins	Coated antigen ELISA	- Protein binding is significantly influenced by pH over the range of 4-10. The pH profile should be examined
○ TopYield	Polycarbonate	+	Proteins with mixed hydrophobic/hydrophilic regions, e.g. immunoglobulins	Immuno PCR	- Excellent heat transmission properties - Excellent stability at the elevated temperatures used for PCR - Designed to facilitate Immuno PCR assays

○ Thermo Scientific Nunc

\* Release tested for binding reproducibility.

△ Thermo Scientific Microtiter

Abbreviations:

FIA - Fluorescent Immunoassay  
LIA - Luminescent Immunoassay  
NA - Nucleic Acid

ELISA - Enzyme Linked Immuno Sorbent Assay  
PCR - Polymerase Chain Reaction  
LPS - Lipopolysaccharide

EDC - 1-ethyl-3-(3-dimethylaminopropyl) carbodiimide  
CV - Correlation of variation

## Surfaces for covalent binding

Covalent coupling, is based on the formation of a single covalent bond between the polymer surface and the biomolecule. Small biomolecules can be immobilized using this technique, as can medium and large molecules that possess the appropriate functional group(s). Since coupling occurs via specific functional groups, biomolecular orientation can also be manipulated by the user.

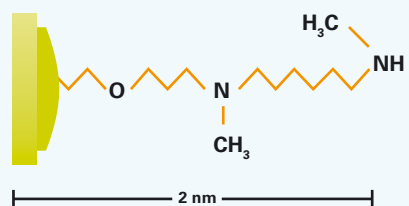
### Surface characteristics

- Strong covalent bonds firmly anchor biomolecules
- Compatible with vigorous washing
- Stability is provided
- Coating with lower amounts of reagent may be possible
- Control of molecular orientation

### Thermo Scientific Nunc CovaLink

The CovaLink™ surface is designed for coupling of molecules bearing a free carboxyl or phosphate group. Therefore, peptides, haptens and DNA can be coupled. The surface uses a spacer arm to increase accessibility, thereby enhancing overall surface reactivity (Fig. 2).

Fig. 2

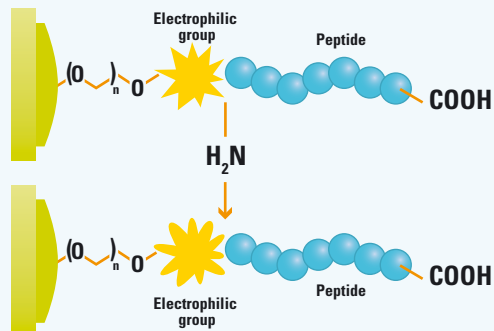


Schematic chemical and physical configuration of the CovaLink NH surface. The NH groups are spaced from the polystyrene surface by 2 nm long (approximately), chemically defined spacer arms, covalently anchored to the surface using a patented method.

### Thermo Scientific Nunc Immobilizer Amino

The Immobilizer™ Amino surface forms stable covalent bonds between its electrophilic groups and the biomolecule's free amino acids or sulfhydryl groups. Using its unique spacer arm chemistry, the surface provides extremely low non-specific binding to improve assay sensitivity. With no need for an ancillary coupling agent, this surface can simplify your assay development by eliminating the need for a time-consuming blocking step (Fig. 3).

Fig. 3



Covalent coupling of a peptide to the Immobilizer Amino plate. During a short incubation step, the peptide will bind to the electrophilic group.

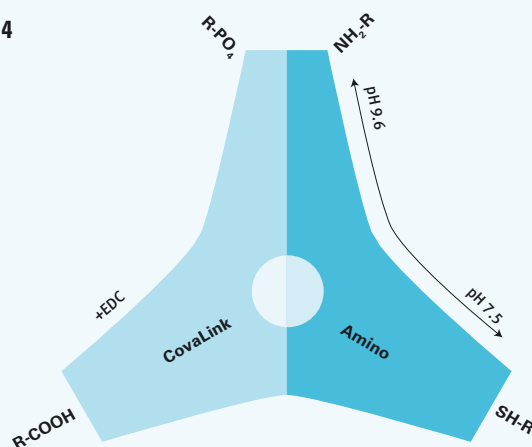
### Thermo Scientific Nunc NucleoLink

The NucleoLink™ surface is a physically modified, thermostable, optically clear resin. It allows the covalent binding of 5'-phosphorylated oligonucleotides, and this together with the thin wall makes NucleoLink highly suitable for solid phase PCR applications.

### The Immobilizer Amino surface is ideal

- If your biomolecule does not bind well to a passive surface, and it possesses one or more free primary amino or sulfhydryl groups (peptides, oligonucleotides, proteins, proteoglycans)
- To obtain a highly sensitive assay with excellent reproducibility and low background
- To minimize the use of a coating reagent
- To reduce the number of steps required to prepare plates
- To avoid unwanted reactivity associated with a blocking reagent

Fig. 4



### Covalent coupling surfaces

#### Covalent coupling surfaces

The diagram shows the available surface modifications for directed binding of target biomolecules. In the case of Immobilizer Amino and CovaLink, a strong covalent bond is formed with the biomolecule being immobilized at the surface. The biomolecule must possess the correct functional group for covalent coupling. The relevant functional groups on the biomolecule are shown in the Fig. 4.

Table 3 shows the link between the surface and the binding preference.

**Table 3.**  
**Covalent Coupling Surfaces**

Name	Base Polymer	Structure	Binding Preference	Key Applications	Features
○ CovaLink	Polystyrene	Secondary Amine on a 2 nm spacer arm	Covalent coupling of biomolecules with -COOH or -PO <sub>4</sub> -groups EDC used for activation of -COOH, PO <sub>4</sub> -groups	Coated antigen ELISA, LIA, FIA	- Can link biomolecules via the COOH group (enables the detection of peptides that bind to an antibody via the NH <sub>2</sub> end) - Spacer arm technology for optimal orientation
○ Immobilizer Amino*	Polystyrene	Reactive electrophilic group tethered on a spacer arm	Covalent coupling of biomolecules with free NH <sub>2</sub> and/or SH groups, e.g. proteins, peptides, aminated oligos	Coated antigen ELISA, FIA, LIA NA Hybridization assays Antibody sandwich ELISA, FIA, LIA	- Immobilize proteins and peptides that do not bind to passive surfaces - Stable covalent bond formation with free NH <sub>2</sub> or SH groups via spacer arm technology - NO BLOCKING REQUIRED - Simple one step protocol. Add coating solution and incubate - Can frequently reduce the amount of biomolecule needed for coating vs. passive plate - High signal-to-noise ratio
○ NucleoLink	Proprietary Polymer	Proprietary surface chemistry provides functional groups for covalent binding	Covalent binding of 5'-phosphorylated or 5'-aminated oligonucleotides and nucleic acids using EDC	Solid Phase PCR, DIAPOPS (Detection of Immobilized Amplified Products), PCR ELISA, NA Hybridization assays	- Heat-stable wells (120°C) with excellent thermal transfer properties - Simplifies PCR assisted hybridization assays; perform the PCR amplification and detection steps in the same well. No need for special real-time PCR equipment - Read in spectrophotometers

○ Thermo Scientific Nunc

\* Release tested for binding reproducibility.

△ Thermo Scientific Microtiter

Abbreviations: FIA - Fluorescent Immunoassay ELISA - Enzyme Linked Immuno Sorbent Assay EDC - 1-ethyl-3-(3-dimethylaminopropyl) carbodiimide  
LIA - Luminescent Immunoassay PCR - Polymerase Chain Reaction CV - Correlation of variation  
NA - Nucleic Acid LPS - Lipopolysaccharide

### Affinity capture surfaces

Affinity capture is based on the specific binding of a tagged biomolecule to its receptor. The plate surface is therefore developed with one of the binding pair (the receptor) immobilized on its surface, while the tag is linked to a biomolecule either by chemical coupling or by genetic engineering. The tagged biomolecule can then be captured on the plate surface with a high degree of specificity.

#### Surface characteristics

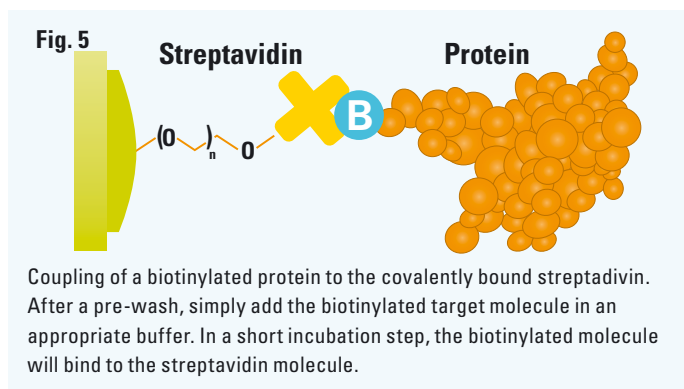
- Affinity tagged biomolecules have highly specific binding
- Reduced variability in molecular orientation
- Immobilizer surfaces improve S/N ratios
- Streptavidin biotin interaction can be exploited to immobilize a wide range of biomolecules (proteins, peptides, haptens, nucleic acids)

#### Passive Streptavidin

Streptavidin is passively coated on the plate with a biotin binding capacity of at least 13-20pmol per well.

#### Immobilizer Streptavidin

The streptavidin protein molecules are covalently bound to the surface via a spacer arm to reduce leaching and enhance precision. The surface is also modified to minimize non-specific binding. As a result, a high S/N ratio is produced, for increased sensitivity. A biotin binding capacity of 20pmol per well produces excellent analytical results (Fig. 5).

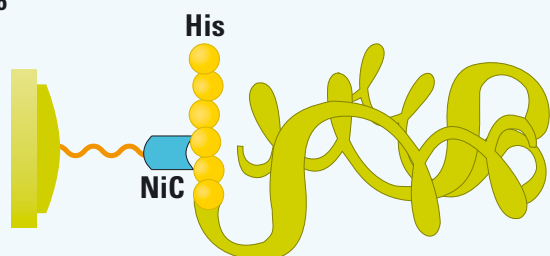


#### Immobilizer Nickel Chelate

A nickel chelate group is attached to the polymer surface via a spacer arm and will bind polyhistidine, which is typical genetically engineered into a fusion protein. The spacer arm design maximizes the reactivity of the surface, while minimizing non-specific binding, and covalent linkage significantly reduces leaching. The surface does not need to be blocked and therefore produces a high S/N ratio (Fig. 6).



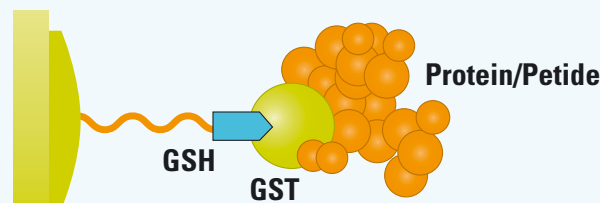
Fig. 6



Coupling of a 6x Histidine-tagged protein/peptide to the Immobilizer Nickel Chelate plate.

His = Histidine  
NiC = Nickel Chelate

Fig. 7



Coupling of a GST-tagged protein/peptide to the Immobilizer Glutathione plates.

GSH = Glutathione  
GST = Glutathione-S-transferase

### Immobilizer Glutathione

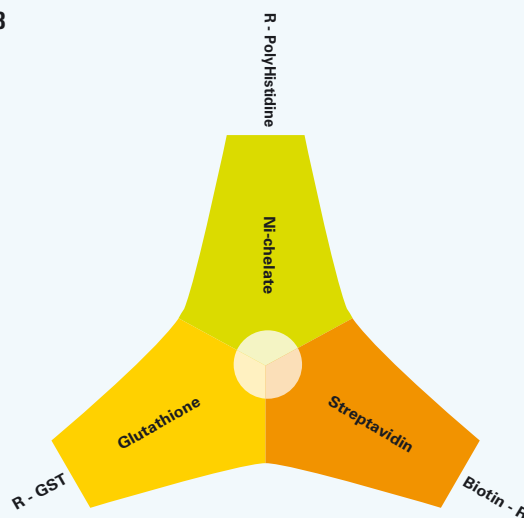
A GST peptide, attached to the polymer surface via a spacer arm, will bind glutathione, which is typical genetically engineered into a fusion protein. The spacer arm maximizes surface reactivity while minimizing non-specific binding, and the covalent linkage reduces the occurrence of leaching. The surface does not need to be blocked and therefore a high S/N ratio is obtained (Fig. 7).

### Affinity capture surfaces

The diagram shows the available surface modifications for directed binding of target biomolecules.

Table 4 shows the link between the surface and the binding preference.

Fig. 8



Affinity capture surfaces

Table 4.  
Affinity Capture Surfaces

Name	Base Polymer	Structure	Binding Preference	Key Applications	Features
○ Passively coated Streptavidin	Polystyrene	Streptavidin passively coated	Biotinylated biomolecules	Immunoassays, protein-protein binding assays, PCR ELISA, NA Hybridization assays	- Passively coated Streptavidin - Biotin capacity: $\geq 13$ pmol biotin per well - Stable at room temperature
○ Immobilizer Streptavidin*	Polystyrene	Streptavidin covalently coupled to polystyrene surface via a spacer arm	Biotinylated biomolecules	Immunoassays, protein-protein binding assays, PCR ELISA, NA Hybridization assays	- NO BLOCKING REQUIRED due to unique surface chemistry - High sensitivity; very high signal-to-noise ratio - Stable at room temperature - Biotin capacity (20 pmol/well) provides large dynamic range for analytical assays)
○ Immobilizer Nickel Chelate*	Polystyrene	Nickel Chelate covalently coupled to polystyrene surface via a spacer arm	6-His tagged fusion proteins	Protein-protein and protein-nucleic acid binding assays, immunoassays	- High sensitivity; very high signal-to-noise ratio - NO BLOCKING REQUIRED due to unique surface chemistry - Stable at room temperature
○ Immobilizer Glutathione*	Polystyrene	Glutathione covalently coupled to polystyrene surface via a spacer arm	Glutathione-S-transferase tagged fusion proteins	Protein-protein and protein-nucleic acid binding assays, immunoassays	- High sensitivity; very high signal-to-noise ratio - NO BLOCKING REQUIRED due to unique surface chemistry - Stable at room temperature

○ Thermo Scientific Nunc

\* Release tested for binding reproducibility.

△ Thermo Scientific Microtiter

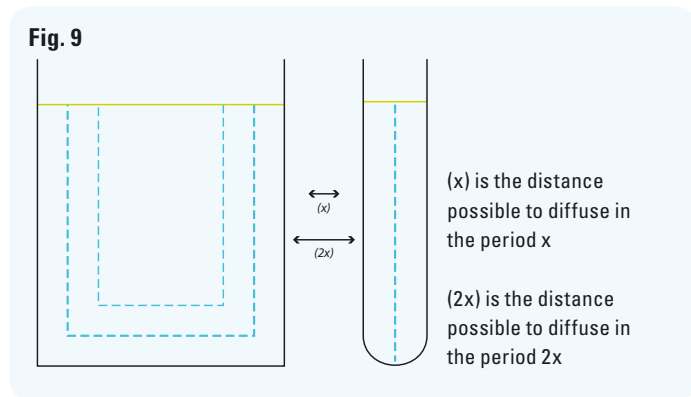
Abbreviations: FIA - Fluorescent Immunoassay ELISA - Enzyme Linked Immuno Sorbent Assay EDC - 1-ethyl-3-(3-dimethylaminopropyl) carbodiimide  
LIA - Luminescent Immunoassay PCR - Polymerase Chain Reaction CV - Correlation of variation  
NA - Nucleic Acid LPS - Lipopolysaccharide

# The Coating

Coating involves the interaction between the solid phase surfaces and reagents in immunoassay. These interactions depend on the following parameters.

## Diffusion Rates

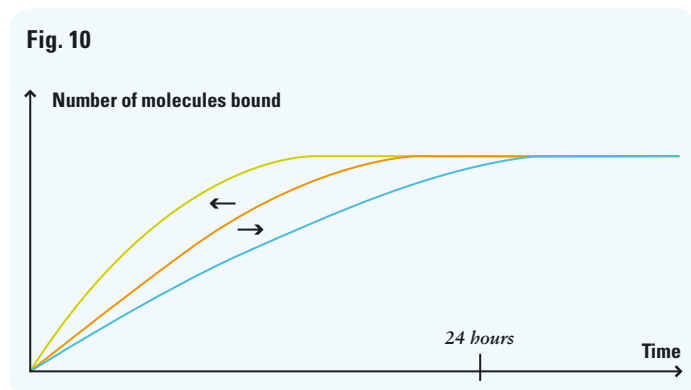
The formation of a stable coating is dependent on the rate of diffusion, on the distance the molecules have to travel to find the boundaries of the container (Fig. 9).



## Time

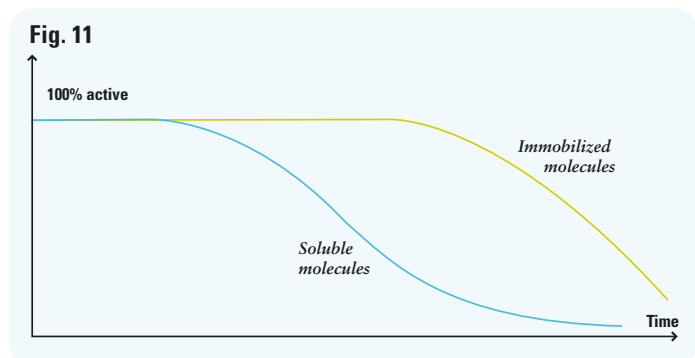
The graph (Fig. 10) shows the relationship between binding and time.

The rising part of the curve is variable depending on the viscosity and other parameters at a given concentration. Time also has a marked effect on the stability of the coating. This can be demonstrated by subjecting the coated surface to a gentle or stringent wash at various times after coating. When this is done, it can be seen that after only five minutes there will be a good coating on the surface, but this coating can withstand only a very gentle wash. The maximum possible coating is approached after two hours. Maximum stability, when subjected to a stringent wash, is seen after six hours for the coating step. Many researchers find it convenient to coat overnight, which gives good stability in most cases.



## Temperature

The rate at which molecular movements take place increases with temperature. The final bound level should be the same in the lower temperature range (4°C to 50°C), but this is not the case when discussing biomolecules. The biomolecules tend to be denatured in solution at high temperatures. Those molecules which are bound to the surface become stabilized, and their rate of denaturation is much slower than in solution (Fig. 11). This incidentally is the reason solutions are best stored cool, and in as concentrated a form as possible. If one is storing a protein in solution, and it cannot be concentrated, a neutral protein (i.e. one which is not involved in the assay) can be added to keep the concentration high, and thus stabilize the reagent.

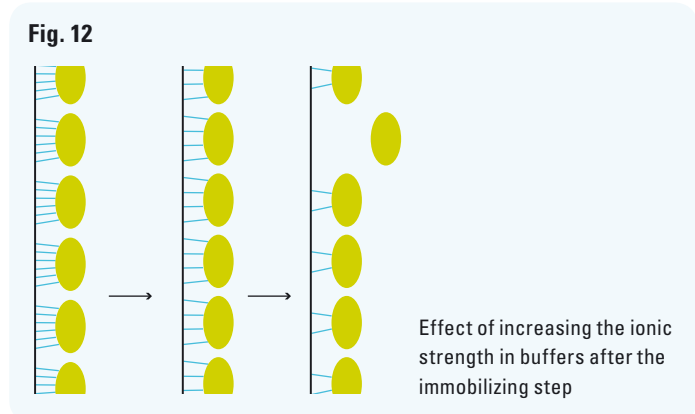


## Concentration

The binding is also dependent on the ionic strength of the coating buffer.

In general, if the coating buffer is of a high ionic strength, the coating is likely to be poor (Fig. 12).

As well as ionic strength, the buffer components themselves can play an important role during the coating procedure. The parameters to consider in this context are hydrophobicity/hydrophilicity and pH. When coating plastic surfaces with proteins or glycoproteins, the recommended buffer is 0.05M carbonate buffer at pH 9.6. The purity of the reagents is also important as any impurities present may bind to the surface occupying a space which could be taken by one of the desired molecules. If the impurity binds less well than the coating molecule, it may later be released and allow an inappropriate molecule access to the surface. This could lead to an unnecessarily elevated background.



## Molecular Weight

Coating with small molecules at a high density can sometimes be a problem, if they are to interact with antibodies. Since the antibodies tend to be >150 kilodaltons (kDa), they will be able to bind with only a few of the small molecules due to steric hindrance and a limited number of sites on the larger molecule. If a small molecule is to be used as the bound phase, CovaLink surface can be used. Otherwise, it is recommended that the small molecule is coupled with an appropriate spacer arm to a larger, neutral molecule which will bind more strongly to the surface and place the ligand at appropriate intervals on the surface. The neutral molecule may also act as a blocker during the assay and thus give a low non-specific binding and fewer false positives.

## Surface chemistry molecular orientation

The orientation of molecules with respect to the surface is only controllable if the molecule is to be bound covalently to the surface. There is usually only one or a few covalent bonds between each molecule and the surface, but these are very stable and strong.

All surfaces bind molecules by physical forces (H-bonding, Van der Waals forces) to some extent. Plastics are very good binding surfaces, particularly polyvinyl chloride (PVC) and polystyrene. There are many variants of both surfaces and great care is taken to choose raw materials and treatments which give predictable binding characteristics with low standard deviation.

Theoretically, it can be calculated that the best polystyrene surfaces can immobilize about 400ng protein/cm<sup>2</sup> if a monolayer is formed. This binding level is little affected by the binding molecule as long as it is medium to high molecular weight. A more detailed description of this can be found in Thermo Scientific Nunc Bulletin No. 6a - 'Principles in Adsorption to Polystyrene' and Bulletin No. 6b - 'Stability of Thermo Scientific Nunc Immuno MaxiSorp Surfaces'.

In vessels made of polystyrene, to which many biologically important molecules will adhere, it is not uncommon to produce surfaces which are 80-90% saturated with the desired reagent. Physical bonds which occur between surfaces and molecules, commonly referred to as adhesion, are numerous, weak and transient. The nature and number of the bonds is dependant of many factors; the most obvious being the size of the molecule being bound. Their value in a solid phase assay system lies in the fact that they are non-specific, and when numerous, quite strong (Fig. 13).

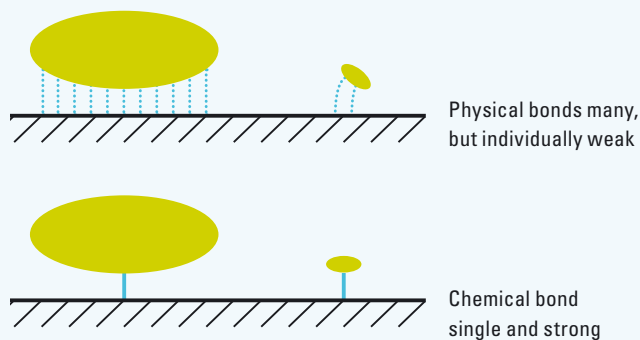
Once a steady state has been reached in the interaction between the surface and the molecules of the coating, this newly created surface is very stable.

When a coating has been established on the surface, it is important that it remains stable during storage.

To stabilize a protein coating first, coat as normal, aspirate and block with milk powder or gelatin aspirate and coat with a 1% solution of sucrose or trehalose for one hour. Aspirate and wash three times with PBS + 0.05% Tween 20 surfactant. Finally, wash three times with deionized water and dry.

Once coated, the storage conditions should be cool and dry. It is assumed that if long term storage is expected, the user will add a preservative such as sodium azide.

Fig. 13



# The Assay

As the interactions needed to make the assay function are the same as those which influence the behavior of the coating molecules, these will only be mentioned briefly.

The influence of altered temperature on the binding time of the reagents is shown in Fig. 10.

As will be seen from the graph, the total bound reagent is the same, but the rate at which the final level is attained is slower when the temperature is lower.

The composition of the assay buffers will influence the binding of the assay molecules. The pH is the parameter which has the most obvious effect on the interactions between the antibody and the antigen. Usually one of the standard assay buffers (e.g. PBS, borate or Tris buffer) will work best. Often assay buffers contain neutral compounds which help to stabilize the other assay components, for example, a blocking protein such as BSA or a mixture of lower molecular weight peptides like casein hydrolysate. In many cases reconstituted powdered skimmed milk has been found to be an excellent blocker. In some cases, where it has been necessary to avoid the use of mammalian protein due to cross-reactivity problems, soya milk has been used successfully as a blocker. The use of such compounds in the assay buffer reduces the background and helps to eliminate false positive results from the assay system.

In an ideal assay, the buffer at each step in the procedure should contain all the previously used components except, of course, the analyte itself. If the assay is to determine a compound in human serum, the buffer after the addition of sample should include blank human serum (a serum known to contain no analyte).

It has also been found that the inclusion of a detergent such as Tween 20 or Triton X-100 surfactant is an advantage in most assay buffers. A detailed discussion of the function and action of detergents in assays can be found in Thermo Scientific Nunc Bulletin No. 8 - 'Detergents in Polystyrene ELISA' and Bulletin No. 9 - 'Blocking Agent and Detergent in ELISA'. Note, that detergent is included only after blocking. If detergent is present before the blocker is in place, it may adhere to the surface. Since the binding of the detergent is likely to be unstable, it may subsequently detach, creating a gap into which other compounds may fit, disturbing the integrity of the blocking layer by allowing a new, unspecific immobilization to take place, leading to increased background.

## Format for a basic ELISA

1. Coat overnight with the coating compound suitably diluted in carbonate buffer (pH 9.6, 0.05M). Add 100 $\mu$ L per well of a Thermo Scientific Microtiter plate or module. This step can be done at room temperature, at 4°C or even at 37°C depending on the stability and characteristics of the molecule involved. It is best if the coating is carried out in the dark. In order to avoid edge effect, assays are best carried out at a constant temperature. For convenience room temperature is often found to be the best choice.
2. Aspirate the contents.
3. Add buffer (PBS) with blocker (e.g. diluted skimmed milk powder at 0.5%). Leave one hour at room temperature. Aspirate the contents.
4. Wash three to five times with 200 $\mu$ L PBS Tween 20

(0.05%) surfactant and blocker.

5. Add sample or standard in analyte liquid. Aspirate the contents.
6. Wash as in 4.
7. Add enzyme-second antibody conjugate in PBS containing blank analyte fluid, Tween surfactant and blocker. Aspirate off the contents.
8. Wash as in 4.
9. Add substrate to visualize.
10. Allow the color to develop for a set time then add stop solution.
11. Read the color intensity and calculate the analyte values with reference to the standard curve generated during the assay.

## Visualization

When immunoassays were introduced, the usual method of visualization was radio-chemically based. In these assays the measurement was made either by contact with a photographic film as in auto-radiography, or by counting the disintegrations with or without scintillant. In today's assays the more common endpoints are colorimetric or fluorescence based. These methods can be as sensitive as the isotope assays, but there are fewer problems with handling and disposal of harmful reagents. The generally safer molecules have all the advantages of the previous methods including the possibility of measuring two analytes simultaneously. This is done by using two different enzyme conjugates conjugated to different second antibodies and having different substrates with differently colored end points. In the visualization step the two different enzyme/substrate systems are applied sequentially to give two independent sets of readings.

When designing an assay with a colored endpoint, it is possible to have a simple yes/no 'out of the laboratory' assay, such as pregnancy test kits for home use. It is also possible to have a semi-quantitative assay with the same principle, by including a standard or two in the assay package, which will give a color development which can be measured in relation to the standards, i.e. within the range set by these standard points.

In the laboratory it is more usual, in a quantitative assay, to include a complete set of standards and to have as low a limit of detection as possible. The added sensitivity in an enzyme based assay system results from the fact that the enzyme can interact with a series of substrate molecules, thus amplifying the signal many fold. This can be compared with a radioactivity based system where it is possible to count for long periods in order to achieve significant figures.

It is, as in all experimental procedures, necessary to include a blank control in the assay to have a measure of the level of spontaneous conversion of substrate. It is also important to add an excess of substrate or to use a short substrate reaction time, in order to avoid the flattening out of the curve that occurs when the substrate is limited. It is recommended that the time allowed for the color development is strictly limited, and that a step is included to stop the reaction. If this is not done, and one is interrupted during the reading process, the standard curve will be disjointed or there will be a 'jump' in the levels measured after the interruption.



Enzyme labels may give rise to different types of signal molecules depending on the substrates used. The simplest signal to measure is the generation of a colored product from a colorless substrate. The rate of production of color depends on the amount of enzyme present, and when the reaction is stopped the intensity of color will be proportional to the concentration of the enzyme, and so with the concentration of the analyte.

## Detection Systems

### Colorimetric endpoints

The two enzymes most commonly used in detection are Alkaline Phosphatase (AP) and Horseradish Peroxidase (HRP).

#### Alkaline Phosphatase

AP catalyses the hydrolysis of phosphate esters of primary alcohols, phenols and amines.

The most commonly used substrate for AP is p-nitrophenyl phosphate, which gives a yellow colored endpoint. Under ideal conditions, this system is an order of magnitude less sensitive than HRP-based systems.

#### Horseradish Peroxidase

HRP reacts with  $H_2O_2$ , and the produced oxygen reacts with a second indicator substrate to form a detectable product.

There are a number of commonly used substrates for HRP. All of these substrates require the addition of  $H_2O_2$ :

- ABTS (2,2'-azinobenzothiazoline-6-sulfonate) is a good all-purpose reagent with a wide working range
- OPD (o-phenylenediamine)
- TMB (3,3',5,5'-tetramethylbenzidine) is often preferred as it gives the highest optical density (OD) value and a low background. Unlike OPD it is not mutagenic.

### Fluorescent and chemi-luminescence endpoints

Fluorometric enzyme immunoassays are capable of greater sensitivity than those with colorimetric endpoints. This is due to the fact that the fluorescent compounds may repeatedly produce a signal. A fluorophore can be used directly or coupled with an enzyme which catalyzes a substrate to a fluorescent product.

The most commonly used substrate in this type of assay is 4-MUP (4-methylumbelliferyl phosphate).

Fluorophores are molecules which absorb light at one wavelength and emit light at a longer wavelength.

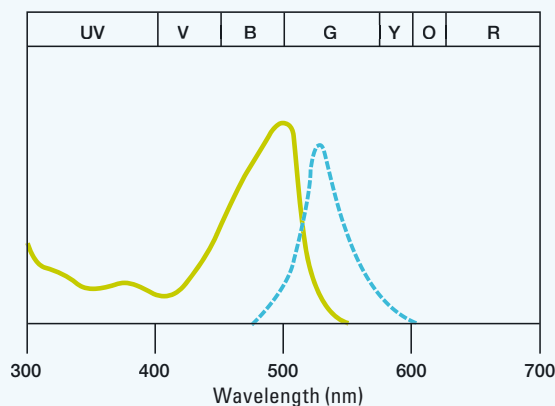
Fluorophores are excited by light exposure: when they return to a lower level of energy (ground state) the fluorophore emits a photon. Thus a fluorescent substance has an absorption (excitation) spectrum of shorter wavelengths and a fluorescence

(or emission) spectrum of longer wavelengths. Often excitation occurs at UV to blue wavelengths, whereas emission is detected at green wavelengths or longer. Fig. 14 shows the absorption and fluorescence spectra for a commonly used fluorescent substance, fluorescein isothiocyanate (FITC).

The difference between the maximum excitation (absorption) and maximum emission (fluorescence) wavelength is known as Stokes' shift, and the ratio of absorbed to emitted light energy is referred to as the quantum yield.

When using fluorescent systems, the excitation and detection wavelengths should be well separated to avoid the accidental detection of excitatory light. This separation is accomplished by use of appropriate filters: One filter between the light source and the sample allowing only shorter wavelengths to reach the sample and another filter between the sample and the photosensor allowing only longer wavelengths to reach the photosensor. For FITC applications filters may be chosen so that excitation takes place at blue wavelengths below 500nm and detection at green wavelengths above 525nm.

Fig. 14



FITC absorption (—) and fluorescence (---) spectra with the color spectrum superimposed. Note the short distance (i.e. small Stokes' shift) between the maximum excitation and emission wavelengths.

The fluorescence is very short lived with emission ceasing almost immediately ( $< 10^{-5}$  s.) Fluorescent tracers have the potential to provide many emitted photons per molecule since the cycle of excitation and fluorescence can be repeated many times for a single molecule during the measurement period.

Assays based on fluorescence have the advantage that they give a higher sensitivity when compared to colorimetric enzyme immunoassays.

Limitations of these systems arise from light scattering, auto fluorescence and quenching.

Light scattering gives a high background reading in solutions containing proteins and small colloidal particles, e.g. those found in serum samples. The narrower the Stokes' shift for the fluorophore being used, the greater the light scatter arising from dissolved molecules, particles or the solid phase.

Background fluorescence can arise inherently from samples and reagents. Serum has a high background fluorescence over a wide wavelength range of approximately 300–600nm, some of the components which contribute to this effect are serum proteins (280nm excitation, 320–350nm emission), NADH and Bilirubin (300–360nm excitation, 430–470nm emission). The use of solid phase immunoassays has the advantage of allowing simple washing and separation steps to remove serum components from the assay system.

An excited molecule can also lose some of the added energy either by collision or by non-radiation energy transfer.

This phenomenon is called quenching. The fluorescent probes may be influenced strongly by minor changes in the micro-environment, e.g. changes in pH, solvent polarity, oxidation state and the proximity of quenching or absorbing groups which can either enhance or quench the signal.

The interference from background fluorescence can to some extent be avoided if there is a time gap between the excitation and measurement of the emitted light. This is the principle behind time resolved fluorescence. Some lanthanides, e.g. europium ( $\text{Eu}^{3+}$ ), form highly fluorescent chelates with certain organic ligands. These have other advantageous features, e.g.

exceptionally large Stokes' shifts and decay times of more than 600ns. The long decay time makes them suitable for time resolved fluorescence. As shown in Fig. 15 this approach lowers the practical detection limits of fluorescence assays which make them a realistic alternative to  $^{125}\text{I}$ -label methods.

## Chemi-luminescence

While fluorescence is a purely physical process, chemi-luminescence is light emission that arises during the course of a chemical reaction. In some instances, the excited molecule is the product of a reaction between the analyte and a suitable reagent, in other cases the excited molecule transfers its energy to another molecule which then produces the emission.

Bioluminescence is a special type of chemi-luminescence found in biological systems in which a catalytic protein increases the efficiency of the chemi-luminescence reaction. Examples of species that exhibit bioluminescence include the firefly, the sea pansy and certain jellyfish, bacteria, protozoa, and crustacea. The principal advantages of such reactions are that they are extremely sensitive and rapid. The label is also relatively stable, has a high specific activity and can take part in an amplification reaction.

Chemi-luminescence reactions provide a very sensitive detection system because no external light source is required as in fluorescence or colorimetric measurements. All the light reaching a detector originates from the chemical reaction with no contribution from scattered excitation radiation which can limit the useful sensitivity of fluorescence detection. The instrumental background signal is essentially zero and hence the contribution of a single chemi-luminescence reaction can be detected as a single photon.

Since in most cases the chemi-luminescence reaction is completed very quickly, signal measurement is rapid. These assays may be performed using any luminometer capable of initiating the reaction in front of the detector. Luminol, isoluminol and other labels of this family have a relatively slow light emission: emission may last in excess of 25 seconds after initiation.

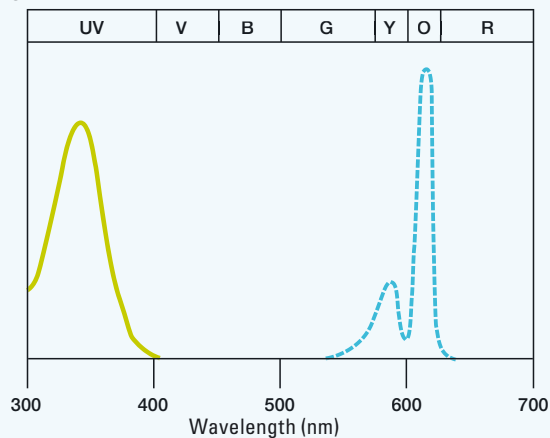
Using enhanced chemi-luminescence, where substituted phenols and naphthols are added to the original substrate, the output of light is increased more than 1:1000. Enhanced chemi-luminescence is a glow which persists for hours rather than a flash of light.

Assays can be performed in opaque Thermo Scientific Nunc MicroWell plates or strips and read in a microwell luminometer. Carry-over of light from neighboring wells is eliminated by the use of opaque MicroWell™ plates or strips which are available in black or white format. White wells enhance the signal by reflecting the light onto the detector, while black plates give less cross-talk from well to well.

## Advantages

Fluorescent and chemi-luminescence probes and substrates are used more and more in assays for detection of bio-molecules. There are two main reasons for the use of these assays. Firstly, these assays are a convenient alternatives to radioactive material. Secondly, it is possible to obtain a higher sensitivity compared to absorption photometry because weak light emission is detected directly as a faint light on a dark

Fig. 15



Europium chelate absorption (—) and fluorescence (---) spectra with the color spectrum superimposed. Note the long distance (i.e. large Stokes' shift) between the maximum excitation and emission wavelengths.

background, whereas weak absorption is detected indirectly as a small difference between two transmission values (sample and blank) each with an inherent measurement error.

The reactions are sensitive, rapid and employ inexpensive reagents and mild reaction conditions. The reactions are well suited for use with a wide range of solid supports, particularly MicroWell plates, and can be monitored by instruments employing photo-multiplier tubes, silicon photodiodes or instant photographic film. Typical detection limits are in ppb (parts per billion). Another advantage of fluorescence and luminescence methods is their large linear concentration range, which is significantly greater than those encountered in absorption methods.

For detection of fluorescence in MicroWell plates or on microscope slides the sample support must be non-fluorescent at detection wavelengths (when illuminated with excitatory light). If the light source is on the opposite of the photo-detector, the support material has to be transparent (translucent) whereas if the light source and the photosensor are both on the same side (sample side) of the solid support, then the support only has to be non-fluorescent at detection wavelengths so that opaque support can be used. One would expect higher sensitivity using supports reflecting the fluorescent light (white solid phase). Black solid phase surface is generally used in epifluorescence when background fluorescence and back scatter can be a problem. Another advantage of fluorescence assays is that fluorescence readings can be repeated if necessary since label measurement is non-destructive. Chemi-luminescence on the other hand offers a rapid throughput for samples if they are automated, but re-analysis is not possible if problems occur with the luminescence detection.

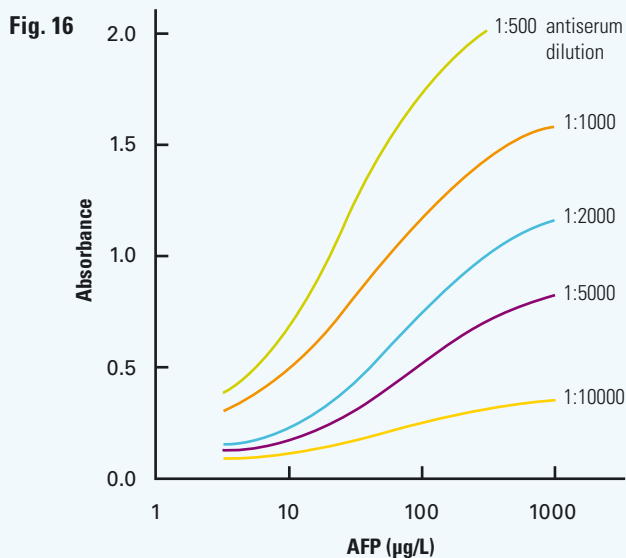
Both luminescence and fluorescence assays can be split into two major applications, one using the label directly by light absorption/chemical reaction, the other using a conventional label such as the enzyme peroxidase or alkaline phosphatase to convert the substrate into a medium with which the label reacts.

## Quick guide to the optimization of an ELISA

The following series of trials is done for the optimization of an ELISA where the anti-serum is the solid phase. It is vital to include controls at every stage.

When building an assay each layer is only as good as the foundation it is laid on. It is therefore vital to start from the bottom, the actual plastic surface, when developing a new system.

1. The first step in optimization is to choose the correct surface. The evaluation of this can be combined with the choice of coating buffer and concentration of coating molecule. Choose a positive sample as standard and use incubation times and temperatures known to work in similar systems. These parameters will be optimized in a later step.
2. Antibody dilution: As can be seen from Fig. 16 the concentration of antibody used has a profound effect on the dose-response curve. At the highest concentration used in this illustration, the 0 point is too high. At 1:1000 in the example there is a good slope and working range. At greater dilutions of the antibody, the working range is reduced as the curve is too flat. If coating with an antigen, a range of concentrations must be tested in a similar way as with antibody.



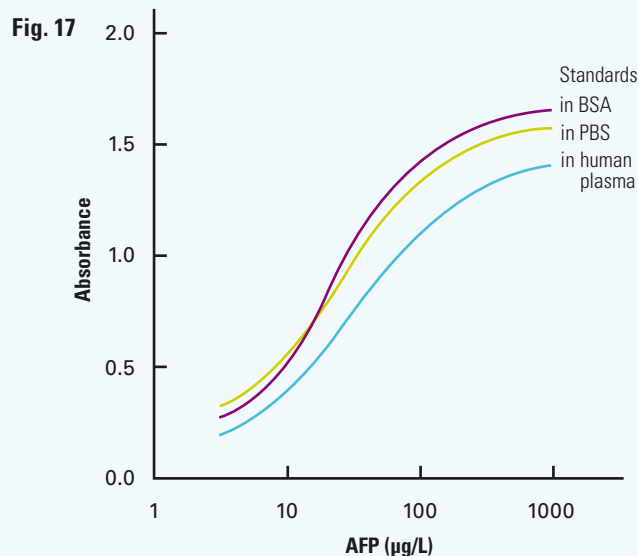
The effect of antibody concentration on the dose-response curve

3. Coating temperature: It is wise, when developing a new assay, to coat at a number of temperatures. The optimum may vary with the specific coating material. The usual temperatures are 4°C, 20°C or 37°C. If the protein is stable across the range, the choice can be made for convenience. Incubation times for coating can be tested at the same time. These times must not be too short as a coating needs time to stabilize. Many people use overnight at either 4°C or 20°C. When coating at 37°C some users have experienced edge effects in their assays.

This phenomenon is caused by temperature differences between wells at the edge and those at the centre of the plate. The simplest way to avoid the problem is to conduct all steps of the assay at the same temperature. As an alternative, the reagents should be added at the incubation temperature, to minimize the well-to-well differences. Details of edge effect can be found in Thermo Scientific Nunc Bulletin No. 1 'Edge Effect in Thermo Scientific Nunc MicroWell ELISA' and Bulletin No. 4 'Aspects of Thermo Scientific Nunc MaxiSorp MicroWell Certification'.

4. Choice and optimization of blocking agent is as important as any other step in the assay. There are many possible choices for blocker, commonly BSA or casein (often in the form of a dilution of skimmed milk powder) are used, but there are many other possibilities including a suitable serum. Include all possible controls at this critical stage, with and without coating molecule, anti-serum or sample, at various incubation temperatures.

Protein/matrix effect: It has been noted that there is a matrix effect which can influence the sensitivity of an assay (Fig. 17). The assay was performed in either PBS, PBS with BSA or citrated human serum. If the samples are in human serum it is therefore important to have the same concentration of this matrix in the controls and standards.



The effect of buffer or matrix on the dose-response curve

5. An important part of the optimization is the fit of the sample concentration to the standard range, in such a way that the measurements of possible 'real' samples will take place on the linear part of the dose-response curve.



6. When choosing reagents, cross-reactivity between them must be considered. If a poor choice has been made, this will clearly be seen when the optimization steps are performed, and a costly reagent may have to be replaced. The concentration of the second antibody enzyme conjugate has as profound an effect on the dose-response curve as does the coating. The choice of concentration of these conjugates is made using the same criteria as for the choice of antibody shown earlier.
7. The enzyme is a catalyst which continues to convert the substrate until the reaction is stopped either by the alteration of the pH (e.g. by adding a stop solution) or by the absence of substrate. The duration of the color development phase will therefore also have an effect. In the presence of excess substrate, the differences observed are small, but generally, the longer this phase, the greater the variability seen from well to well. It must be kept in mind that there is an upper limit to the measurable extinction. This limit may be reached if very large quantities of substrate are used, or color development continues for very long periods. More detailed treatment of these aspects of the assay can be found in Thermo Scientific Nunc Bulletin No. 4 'Aspects of Thermo Scientific Nunc MaxiSorp MicroWell Certification'.
8. Protein in the wash buffer has been found to improve the dose-response curve. A neutral protein must be chosen to avoid problems of cross-reactivity. Some workers have found chicken serum to be economical and effective, others use skim milk powder, but each individual assay parameter must be tested.
9. In order to be certain that the assay is specific, i.e. that you are measuring the specific binding of the analyte to the coating molecule, there is a simple check which can be performed. Pre-incubate a mixture of the analyte at a known midrange concentration with unbound coating biomolecule for one hour at 37°C. Use this mixture as a sample in the normal assay system in parallel with the analyte at the same concentration. If the assay is specific, the test sample of the mixture will give a lower signal when measured.

Each time a new assay is developed, the whole optimization procedure is recommended. In this way you will efficiently arrive at a good working assay which gives reliable results.

Both positive and negative controls must of course also be included each time an assay is run.

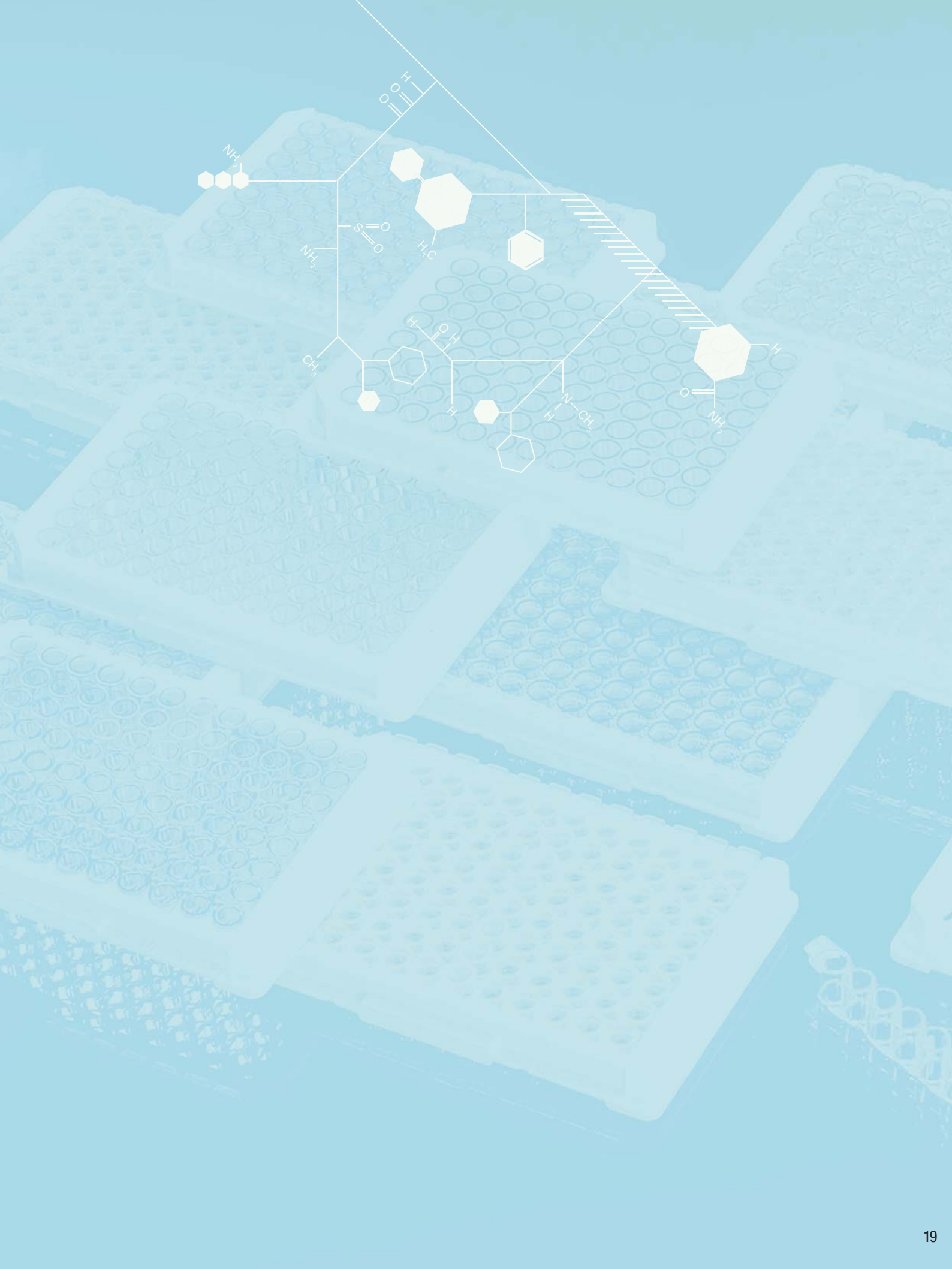
A detailed discussion of the behavior of capture reagents, their importance in the assay and the optimization stages of assay development can be found in Appendix 4 - Capture, pre- and post-capture reagents.

# Troubleshooting

Problem	Possible cause	Solution
High background	No Blocker	– Use a neutral protein blocker
	Detergent before blocker	– Use detergent only after blocker
	Wrong surface	– Check properties of available surfaces
	Cross-reaction	– Check reagents for compatibility
Poor duplicates	Poor washing	– Check washer pin alignment – Fill and empty wells – Completely 3-5x – Use appropriate wash buffer
	Variable incubation time	– Use a stop solution – Work systematically* and rhythmically in the same sequence for all additions
	Pipetting error	– Wet tip in reagent before dispensing
No signal	Preservative in buffer	– Check compatibility of reagents
	Reagent omitted	– Check protocol
	Reagent deteriorated	– Check storage conditions, make fresh
	Coating deteriorated	– Check surface or make fresh
Too much signal	Instability of the reader lamp	– Check lamp – Add stop solution
	No stop solution	– Check lamp – Add stop solution
	Visualisation time too long	– Adjust time
	Cross-reactivity	– Check compatibility of reagents, e.g. blocker protein same animal source as antibody
	Wells dry out	– Fill wells with buffer when not in use
Poor signal	Buffer miss match	– Check compatibility of buffer with enzyme
Edge effect	Differential temperature	– Conduct assay at a constant temperature, e.g. room temperature add reagents at incubation temperature**
	Evaporation	– Use a heat block not an incubator**

\* See Thermo Scientific Nunc Bulletins No. 8 'Detergents in Polystyrene ELISA' and Bulletin No. 9 'Blocking Agent and Detergent in ELISA'

\*\* See Thermo Scientific Nunc Bulletins No. 6a 'Principles in Adsorption to Polystyrene' and Bulletin No. 6b 'Stability of Thermo Scientific Nunc Immuno MaxiSorp Surfaces'



# Frequently Asked Questions (FAQs)

## Passive Adsorption

### Which 96 well Immuno plates or modules are appropriate for which application?

The following list offers a brief description of the features of Thermo Scientific Nunc products and their specific applications.

- **Immuno plates, MaxiSorp™ surface**  
These plates are designed for solid phase immuno-assays and have a polystyrene surface with high affinity for polar groups and hydrophilic molecules. These 96 well plates are available with flat (F), round (U) or (C) bottom well designs.
- **Immuno plates, PolySorp™ surface**  
These plates have a polystyrene surface which adsorbs less polar molecules compared to the MaxiSorp surface and has a high affinity for hydrophobic groups. These 96 well plates are available with flat (F), round (U) or (C) bottom well designs.
- **Immuno modules**  
These modules are designed for solid phase immunoassays. The modules are available in 8, 12 or 16 well formats with (F), (U) and (C) bottom well and 8 well BreakApart™ with (C) bottom well designs. These different formats allow one to choose the style which is appropriate for their assay design. BreakApart modules and LockWell™ modules can be used for radio-immunoassays.
- **Immuno StarWell™ modules**  
The 8 well modules feature eight fins on the inner wall of the (C) bottom wells. This design increases the surface area by 50%. The increase in surface area allows more molecules to be immobilized, increasing assay signal. The fin configuration provides shorter diffusion distance to the surface, reducing incubation times.
- **LockWell modules**  
Each plate consists of 1 x 8 breakable strips. These strips are assembled in a designed frame which locks each well into place by a spring lock.  
This spring lock design orientates each well at the same horizontal level allowing uniform washing and reading. The LockWell modules are available with round (U), (C) or StarWell bottom well designs.
- **Thermo Scientific Nunc FluoroNunc modules and plates**  
These plates are optimized for IFMA (Immunofluorometric Assays) or FIA (Fluorometric Immuno Assays). The transparent polystyrene plates give a low background fluorescence and are optimal where a readthrough system is used. The white plates/modules provide maximum reflection of fluorescence signal while maintaining low background. The white plates/modules are often used for epifluorescence reading. Black modules reduce background fluorescence and minimize back-scatter light which is often encountered in epifluorescence.

### What are the advantages of one well geometry type over another? Which is best for which application?

The following list describes the geometries of wells available for Immuno plates and modules.

- **Flat bottom (F)** - Allows maximum transmission of light. These plates can be read on a monochromatic reader.
- **Round bottom (U)** - This geometry optimizes washing and coating. These plates can be read using a dual wavelength reader.
- **"C" bottom (C)** - This design of the well is a combination of both flat and round bottoms. Basically, it is a flat bottomed well with curved edges at the bottom. These plates also can be read using a monochromatic reader combining optimal reading and washing.
- **StarWell** - These wells have a modified "C" shape geometry with eight fins strategically placed at the bottom. This feature increases surface area, allowing more molecules to become immobilized which reduces incubation times.

### What is the difference between PolySorp and MaxiSorp surfaces?

MaxiSorp and PolySorp surfaces were developed for immunology assays. The MaxiSorp surface is a modified, highly charged polystyrene surface with high affinity to molecules with polar or hydrophilic groups. The surface has a high binding capacity for proteins, including globular antibodies in proper orientation. Thus, it offers very high

sensitivity in double antibody "sandwich" tests. The PolySorp surface is more hydrophobic than the MaxiSorp surface. It has high affinity to molecules of a more hydrophobic character. This surface is particularly suited to non-protein antigens including virus antigens. The Thermo Scientific Nunc MiniSorp surface is a polyethylene surface with very low affinity to molecules of any type. This type of surface is ideal for the liquid phase immuno techniques.

### What is the maximum binding capacity for proteins on the MaxiSorp surface and the PolySorp surface?

Molecules bind to the PolySorp and MaxiSorp surfaces through passive adsorption. Using IgG as a reference molecule and knowing that it is a globular molecule, theoretical calculations indicate that the maximum binding for the MaxiSorp surface, in monolayer, is 650ng/cm<sup>2</sup>. For the PolySorp surface, the binding capacity is 220ng/cm<sup>2</sup>. A detailed discussion of the principles and calculations is presented in Thermo Scientific Nunc Bulletin No. 6a 'Principles in Adsorption to Polystyrene' and Bulletin No. 6b 'Stability of Thermo Scientific Nunc Immuno MaxiSorp Surfaces'.

### Which surfaces are recommended for radio-immunoassay (RIA)?

The choice of plates or modules will depend on the type of RIA you are planning to perform as well as specific assay conditions. Thermo Fisher provides two different surfaces for immunoassays, PolySorp and MaxiSorp. The MaxiSorp surface is highly charged and should be used if the assay requires quantitative measurement of proteins (antibodies) or molecules with polar groups. The PolySorp surface should be used if the assay consists of less polar molecules with hydrophobic characteristics.

### When performing ELISA using Immuno MaxiSorp plates, what are the recommendations for reducing high background readings and non-specific binding?

Assay sensitivity depends strongly on an efficient removal of non-specific reacting molecules. High background readings and coating instability can be eliminated by addition of a blocking step after the first coating. The excess surface is then occupied by indifferent molecules. We recommend washing three times after each coating step by using a solution of 0.15M phosphate buffer (pH 7.2) with 0.2M NaCl and 0.05% Tween 20 surfactant. For blocking, we recommend using 0.5% BSA, 1% casein or 1% gelatin in 0.15M phosphate buffer (pH 8.2) or carbonate buffer (pH 9.6). See Thermo Scientific Nunc Bulletins No. 7a 'Comparison of Blocking Agents for ELISA', Bulletin No. 8 'Detergents in Polystyrene ELISA' and Bulletin No. 9 'Blocking Agent and Detergent in ELISA'.

### What is the difference between certified and non-certified MaxiSorp plates and modules?

Both of these surfaces are identical. The only difference between them is that for the certified plates, a representative sample from each manufacturing lot undergoes a Binding Capacity test. This test is an ELISA-like assay used in our quality control laboratories to ensure binding capabilities. See Thermo Scientific Nunc Bulletin No. 4 'Aspects of Thermo Scientific Nunc MaxiSorp MicroWell Certification'.

### Will Immuno plates/modules fit into an automated microtiter plate reader or washer?

Yes. All 96 well plates and frames for modules have a standard 96 well footprint, 86 x 128mm.

### Does Thermo Fisher Scientific offer a manual plate washer for immunology assays, such as ELISA?

Thermo Fisher Scientific offers a manual plate washer which is compatible with 96 well plates, Immuno Wash 8 and Immuno Wash 12. Each Immuno Wash has two fittings. One fitting is connected to the wash buffer solution and the other to a vacuum line for aspiration. The wash buffer solution is dispensed manually.

#### **Which components are included in the Immuno Wash Tubing Kit?**

The tubing kit consists of tubing, Y-shaped adaptor, and three red clamps.

#### **Is the 8 well strip cap compatible with all 96 well MicroWell or Immuno plates?**

The 8 well strip caps were designed to provide a positive seal for flat and round bottom wells of 96 MicroWell or Immuno plates. The 8 well strip caps are not compatible with C or V bottom wells of 96 MicroWell or Immuno Plates.

#### **Is it possible to bind either single or double stranded DNA to the MaxiSorp surface?**

Single stranded DNA can be adsorbed to MaxiSorp surface using approximately 10µg ssDNA per mL PBS, pH 8.2. The stability is uncertain. Based on our experience, ssDNA immobilized on the MaxiSorp surface is so loosely bound that it is removed by stringent washing. Double stranded DNA will not bind to the MaxiSorp surface. DNA, however, can be covalently bound to NucleoLink strips.

#### **What is the Transferable Solid Phase (TSP) and its advantages?**

The TSP is a disposable 96 pin device on which solid phase reactions can be performed. It is available with a PolySorp and MaxiSorp surface. The pins are coated by submerging in analyte solution contained in a 96 well plate. Washing and reaction with succeeding antibody or streptavidin conjugates can be performed by transferring the TSP into a washing tray. For hybridoma screening, the TSP is available in a sterile version. Likewise, the TSP can be used for a simultaneous detection of two different molecules in the same solution. Advantages include: identical reaction times on all pins, no need for plate washer/dispenser, and allowance for a second solid phase reaction to be conducted in a single 96 well plate.

#### **What are some applications using the Transferable Solid Phase (TSP)?**

Reactions such as the ELISA can be performed on the TSP. The pins are coated by submerging in the analyte solution contained in a 96 well plate. Washing and reaction with succeeding antibody or streptavidin conjugates can be performed by transferring the TSP into a washing tray or second 96 well plate filled with the appropriate solution. The TSP is placed into a substrate solution until color is observed and is then removed to ensure a simultaneous start and stop to the enzymatic reaction.

The TSP is available sterile for screening hybridoma cells for the production and secretion of monoclonal antibodies. For radio-immune assays, the TSP can be placed directly on X-ray film and exposed for several hours. Only the tips of the pins should be incubated with the radiolabeled reagent. The TSP can also be used with the Thermo Scientific Nunc OmniTray for performing dot blots and for replicating bacterial clones from a 96 well plate. See Thermo Scientific Nunc Tech Note No. 24 'In Situ Screening of Bacterial Colonies - Protocols'.

#### **What is the principle behind ELISA spot?**

The ELISA spot technique was originally described by Sedgwick & Holt, Journal of Immunological Methods, 57, 301, 1983. The basic principle is as follows:

1. Coat solid phase with antigen
2. Block free sites using serum
3. Add antibody producing cells (plasma cells) from animal, e.g. mouse sensitized with the coated antigen
4. Incubate
5. Wash away cells
6. Add anti-mouse antibody conjugated with alkaline phosphatase
7. Incubate
8. Wash
9. Add substrate
10. Incubate
11. Read number of spots (converted substrate)

ELISA spot can also be used to assay products secreted from cells placed in contact with antibody coated on the solid phase.

#### **What length of peptide is ideal for binding to the MaxiSorp surface, and what are the detection limitations?**

We have discovered that a seven amino acid peptide from the MHC Class II antigen can be detected when adsorbed on the MaxiSorp surface. We state that the detection limitation using the MaxiSorp surface is between three and seven amino acid residues. One additional note is that detection is contingent upon the orientation of the peptide when immobilized. If the active site is inactivated or hidden at the site facing the solid phase, no detection signal is observed.

## **Covalent Surfaces**

### **Immobilizer Amino plates and strips**

#### **What is the technology behind the Immobilizer plates and strips?**

The technology is based on the unique patented anthraquinone photo-coupling method which provides a simple one-step procedure for covalently coupling biomolecules. The photo-probe consists of three parts: The anthraquinone molecule, the ethylene glycol spacer and an electrophilic group. The density of the electrophilic groups and the spacer design is optimized for immobilizing either peptides, proteins, or antibodies.

#### **Which type of plates and strips should I use for the different detection methods?**

We recommend using transparent polystyrene plates and strips for colorimetric assays, white opaque polystyrene plates and strips for bio and chemi-luminescence assays, and black opaque polystyrene plates and strips for fluorescence assays.

#### **Why is the Immobilizer surface better than passive adsorption?**

The Immobilizer surface binding has several advantages over passive binding to solid phases. One of advantages of the Immobilizer plates and strips is the strong covalent binding of the anthraquinone to the MicroWell plate. This means that there will be no leaching of the bound molecule. The use of stringent washing procedures and Tween 20 surfactant will further avoid unspecific binding in the wells. The coefficient of variation (CV) between the individual wells will also be very low and will give uniform, reproducible results.

#### **Should I optimize the concentration of the target molecule?**

Yes. We recommend that the amount of target molecule is optimized. Initially, we suggest making a titration of the biomolecule and load different concentrations in the wells in the dedicated buffer.

#### **Which detection method can measure low amounts of analyte?**

Low concentrations can frequently be detected using the Immobilizer plates and strips. A low limit for detecting a good signal is normally around OD=1.0. Depending on enzyme, substrate, equipment and reaction requirements, the different detection assays can be optimized to meet the necessary sensitivity. In theory, luminescence assays will be the best choice for detecting low signals.

#### **Could there be any problems during the coupling procedure?**

To avoid any problems ensure that the biomolecule has a free primary amine, thiol or hydroxyl group that will react with the electrophilic group on the spacer. Also, avoid competition from other nucleophiles like ethanolamine, lysine or Tris during the coupling. Further, do not use non-ionic detergents like Tween 20 surfactant in the coupling buffer since the covalent coupling of the biomolecule will be suppressed.

#### **Why do we advise Tween 20 surfactant in washing and in assay buffers?**

Tween 20 surfactant blocks any available binding sites. In combination with the stringent washing procedure this detergent generally improves the signal-to-noise ratio of the assay. We recommend using buffers containing 0.05-2% Tween 20 surfactant.

**Can the molecule be bound, but not recognized during the detection?**

Yes. If lysine or cysteine is a part of the epitope recognized by the antibody then a binding of these amino acids to the photo-probe will lead to a reduced recognition and a lower signal. An increase in the analyte concentration could solve this problem.

**For how long time should I incubate the target molecule to the Immobilizer plates and strips?**

Coupling of the target molecule to the anthraquinone photo-probe proceeds very fast. Results shows that incubation with gentle agitation for two hours at room temperature secures that the available active sites are saturated.

**For how long are the plates stable?**

The Immobilizer Amino plates and strips are extremely stable for a long time if stored at room temperature protected from light. We guarantee a 24 month shelf life after the date of manufacturing.

**Can I use target molecules other than peptides and proteins?**

Yes, but the protocol needs to be optimized and the target molecule should be modified if it does not contain nucleophilic groups.

## CovaLink plates and strips

**What are the applications of CovaLink modules?**

1. CovaLink modules are used for immunoassays allowing an orientation of the immobilized molecule.
2. Detection of antibody levels to polysaccharide components of infectious agents. See Thermo Scientific Nunc Tech Note No. 11 'DIAPOPS using Thermo Scientific Nunc CovaLink BreakApart Modules'.
3. Signal amplification of target by the use of covalently bound primer and hybridization procedures. CovaLink NH is a good product for hybridization of amplification product with covalently bound probe. Amplification is performed and hybridization of the amplified product is accomplished using CovaLink modules (See Rasmussen et al., Clin. Chem. 40(2), pp. 200-5, 1994.

**When is the use of CovaLink modules necessary?**

CovaLink is recommended for use with molecules which adsorb with difficulty to a traditional surface. Because of covalent binding very thorough washing is possible allowing orientation of the molecule and better recognition by the detection molecule.

**What are the recommendations for improving binding efficiency of proteins and DNA (nucleic acids) using secondary amine CovaLink modules?**

Use a freshly made methylimidazole and carbodiimide condensing agent for optimal covalent binding of both proteins and DNA (nucleic acids). The binding efficiency of single stranded oligo (a 5'-phosphorylated end of a single stranded oligomer binds with a phosphoramidate bond) is about 8-10% with a typical 25 base oligo.

**What are the features of the secondary amine CovaLink surface?**

CovaLink NH Modules are surface modified optically clear polystyrene modules in strips of eight. They allow covalent binding of distinct groups of proteins, peptides, oligosaccharides and DNA. This covalent binding feature allows orientation of the bound molecules so that the active site of the molecule is available for biochemical activity. A key feature of the CovaLink is that the polystyrene surface is grafted with secondary amino groups which serve as bridges for covalent binding. The optically clear surface allows reading of fluorescent or colorimetric signals.

**What is the stability of the secondary amine CovaLink surface with protein or DNA bound to the surface?**

DNA, proteins or peptides bound to the CovaLink surface can be stored at 4°C for up to one month.

**What length of peptide is ideal for binding to the Covalink NH surface, and what are the detection limitations?**

We have tested and found that a three amino acid peptide (Pro, Leu, Gly) cannot be detected when passively adsorbed on the MaxiSorp surface. However, this peptide can be detected when covalently immobilized using CovaLink NH modules and plates.

Using covalent immobilization of small peptide residues, one can obtain a better orientation of the molecule and reduced problems with antibody recognition of the peptide due to masking of the epitope.

## Affinity Capture Surfaces

### Immobilizer Streptavidin plates and strips

**Which type of target molecules can be used?**

When working with the Immobilizer Streptavidin plates instant coupling of biotinylated biomolecules will occur. The Immobilizer Streptavidin plate is especially designed and optimized for detection biotinylated oligonucleotides, peptides and proteins.

**Which type of plates and strips should I use in the different detection methods?**

We recommend using transparent polystyrene plates and strips for colorimetric assays, white polystyrene plates for bio and chemiluminescence assays and black polystyrene plates for fluorescence assays.

**Should I optimize the concentration of the target molecule?**

Yes. We recommend that the amount of target molecule is optimized. Initially, we suggest the following:

**Biotinylated oligonucleotides:**  
0.5–0.01µM diluted in 5 x SSCT buffer pH = 7.0

**Biotinylated peptides:**  
1µg/mL – 1ng/mL diluted in a PBST buffer pH = 7.2

**Biotinylated proteins:**  
5–0.05µg/mL diluted in a PBST buffer pH = 7.2

**Why should I wash before use?**

It is highly recommended to pre-wash the Immobilizer Streptavidin plate. This will ensure improved readouts and a very low coefficient of variation (CV% ≤ 5) from plate to plate and from well to well.

**What is the binding capacity?**

Total binding capacity for free biotin is:  
20pmol/well in a 96 well (coating volume 100µL)  
10pmol/well in a 384 well (coating volume 50µL)

**For how long should I incubate the biotinylated target molecule with the streptavidin surface?**

Coupling of the target molecule to the streptavidin proceeds very fast. Results show that incubation with gentle agitation for two hours at room temperature ensures that all available active sites are saturated.

**For how long are the plates stable?**

The Immobilizer Streptavidin plates and strips are extremely stable over time, if stored at room temperature (20-25°C). We guarantee 18 months shelf life in unopened foil package after the date of manufacturing.

**Why am I getting a high background signal?**

The reason could be inadequate washing. Make sure to pre-wash the plates and increase the number of washing steps and the time between washes. The reason could also be too high a concentration of the detection components.

## Immobilizer Nickel Chelate plates

### Which type of molecules can be used?

The Immobilizer nickel chelate plates can via a simple one step protocol bind all types of His-tagged fusion proteins/peptides. This includes purified as well as crude cell lysates containing His-tagged fusion proteins/peptides.

### Can the Immobilizer nickel chelate plates bind proteins containing less than six neighboring His amino acids?

Due to steric hindrance, optimal performance is normally observed if the fusion protein contains more than four neighboring histidine amino acids located at the terminal end. In some cases the histidine amino acids do not need to be placed next to each other – just be sure that the 3D structure fold them next to each other (e.g. the HAT fusion protein).

### Is the interaction between the nickel chelate complex and histidine pH dependent?

Yes. The interaction is pH dependent, and binding is best obtained at neutral pH or slightly above. We recommend using 10mM KCl, which has a neutral pH, as a coupling buffer.

### Which type of plates should I use in the different detection methods?

We recommend using transparent polystyrene plates for colorimetric assays, white polystyrene plates for bio and chemi-luminescence assays, and black polystyrene plates and for fluorescence assays.

### Why is it recommended to pre-wash?

We recommend pre-washing with PBS containing 0.05% (v/v) Tween 20 surfactant to saturate the plate surface. This minimizes the non-specific binding during the assay and provides a low background.

### Should I optimize the concentration of the His-tagged protein/peptide?

Yes. When setting-up the assay, the concentration of the His-tagged protein/peptide should be determined by preparing a titration. We recommend using a solution of the His-tagged fusion protein/peptide diluted in KCl, in a concentration ranging from 0.01-10µg/mL. Hereafter, the primary and secondary antibodies should be optimized according to the manufacturer's recommendations.

### What is the stability of the microplates?

The Immobilizer nickel chelate plates are extremely stable over a long period of time, if stored at room temperature (20-25°C). We guarantee 12 months of shelf life in unopened foil package after the date of manufacturing.

### What is the detection limit?

The detection limit for each protein depends on the assay system used (e.g. primary and secondary antibody, incubation time, detection reagent), the accessibility of the His-tagged fusion biomolecule, and the size of the protein (large proteins bind with a low density). Using a 25kDa 6xHis-tagged protein, we have observed a detection limit of 1.0ng per well (100µL).

### Can the plates be used to measure the amount of bound His-tagged fusion protein/peptide?

To determine the approximate amount of bound His-tagged fusion protein/peptide, a standard curve of a previously purified preparation can be applied.

### Could any reagent interfere with the binding between the nickel chelate complex and the His-tagged fusion biomolecule?

Ionic detergents (e.g. SDS) will interfere with the binding as well as high concentrations of chelating reagents like EDTA, EGTA, and very strong electron donors like urea, and metal ions.

### Is it possible to elute the bound His-tagged fusion protein/peptide from the surface of the plates?

Yes. For instance use imidazole in concentrations >500mM in Tris at pH = 7.5 or a high concentration of EDTA.

### Why should I use ultra-pure water during the experiment?

The water used for washing of microplates as well as all assay reagents, must be of absolutely ultra-pure quality. This means no metal ions, present in the water, as this will bind to the His-tag and thereby decrease the binding of the fusion protein to the nickel chelate complex.

## Immobilizer Glutathione plates

### Which type of molecules can be used?

The Immobilizer Glutathione plates are designed for optimal detection of glutathione-S-transferase (GST)-tagged proteins or purified GST.

### Which type of plates and strips should I use in the different detection methods?

We recommend using transparent polystyrene plates for colorimetric assays, white polystyrene plates and for bio and chemi-luminescence assays and black polystyrene plates and for fluorescence assays.

### Should I optimize the concentration of the purified GST or GST-tagged protein?

Yes. We recommend using a solution of the purified GST or GST-tagged protein diluted in Phosphate Buffered Saline (PBS), pH = 7.2 in a concentration ranging from 0.01-1µg/mL. During the coupling non-ionic detergents like Tween 20 surfactant should not be present, as these will suppress the coupling.

### Why should I use Tween 20 surfactant in the washing step and in the buffers containing the antibodies?

We recommend using Tween surfactant as the non-ionic detergent as it will improve the signal-to-noise ratio of the assay since it will decrease the background.

### Can I whirl-mix solutions containing GST proteins?

No. Do not whirl-mix a solution containing GST-tagged proteins. The CV will increase due to slight degradation of the GST protein.

### Can the concentration of an unknown GST-tagged protein be determined?

To determine the approximate concentration of the GST-tagged protein, a standard curve should be generated using purified GST added in different concentrations to the wells of the plates. Please note, it is only the approximately concentration that can be determined since not 100% of the GST-fusion proteins will be bound due to denaturing or steric hindrance to GSH.

### How long are the plates stable?

The Immobilizer Glutathione plates are extremely stable over long periods of time, if stored at room temperature (20-25°C). We guarantee 12 months of shelf life in unopened foil package after the date of manufacturing.

### What is the detection limit?

The background is extremely low when using the Immobilizer Glutathione plates. This results in a high signal-to-noise ratio and a low detection limit which in general means that the detection limit (OD 0.5) is 3ng per well (100µL).

# Immobilization of DNA

## Solid phase DNA assays

So far we have been discussing immunoassays on a solid phase. Our next subject will be the covalent coupling of oligonucleotides to a polymer surface. This technique is utilized for detection of e.g. PCR products by solid phase PCR or PCR-ELISA.

## NucleoLink strips

NucleoLink is an activated polymer which mediates covalent and heat-stable binding of 5'-end phosphorylated or 5'-end aminated oligonucleotides. A linker of at least 10 thymidine residues is recommended for improved kinetics. The covalent bond is created between the surface and the labeled oligonucleotide via a carbodiimide condensation.

The NucleoLink surface has a high binding capacity for oligonucleotides. Adding 100ng oligonucleotides per well, the resulting amount of covalently bound oligonucleotide is approximately 20ng as shown in Fig. 18. This is approximately 2.5pmol per well of an oligonucleotide of 25 bases. The number of oligonucleotides on the surface available for hybridization has been analyzed to  $6 \times 10^{11}$  per  $\text{cm}^2$  or approximately 1.25pmol.

In comparison, a competing product for covalent immobilization of DNA using a similar binding chemistry requires the addition of 60 times more oligonucleotide than used with NucleoLink, but NucleoLink still binds three times more DNA.

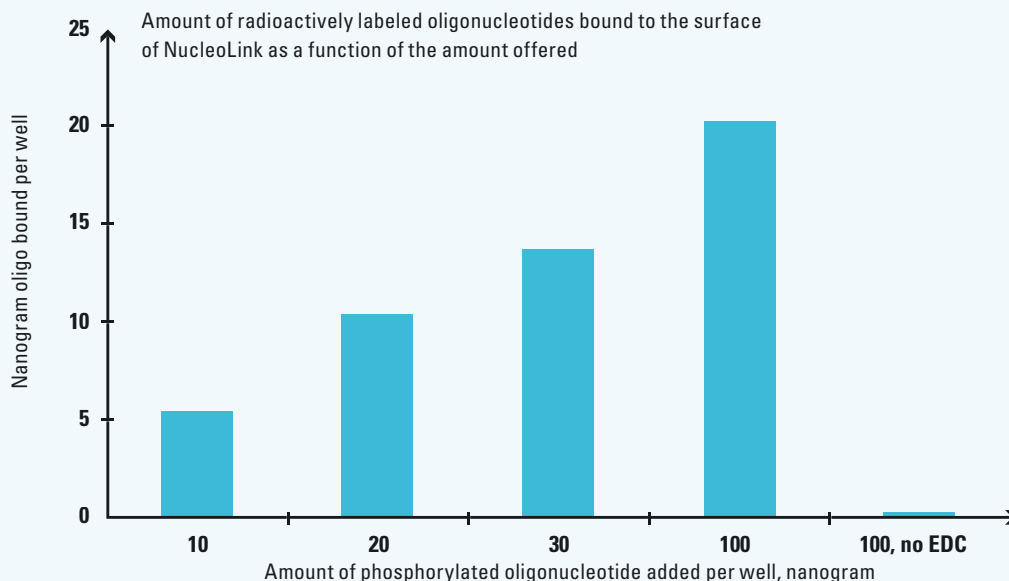
## Standard detection of PCR products by gel electrophoresis

Traditionally, PCR products are detected by agarose gel electrophoresis. This detection system has several disadvantages. It is difficult to standardize since the results are not based on figures. Gel electrophoresis gives a poor detection limit, is non-specific and only subjective product quantification is possible unless a gel scanner is available. These problems can be overcome by solid phase PCR or PCR-ELISA.

## Solid phase PCR

In solid phase PCR, DNA amplification and detection by hybridization take place in one well. In this way no transfer from amplification system to detection system is necessary reducing the risk of cross-contaminations. The amplification takes place on the NucleoLink surface, and the amplicons are covalently bound to the surface during the process. The amplicons are subsequently detected by hybridization in the same well. This combined solid phase PCR and detection by hybridization technique is called DIAPOPS.

Fig. 18





## DIAPOPS

DIAPOPS means Detection of Immobilized Amplified Products in a One Phase System. In this method one of the PCR primers, the solid phase primer, is covalently coupled to the NucleoLink surface. This primer must be phosphorylated or aminated in the 5'-end, or there will be no binding (Fig. 19).

The solid phase primer is also present in the liquid phase but here without 5'-end modification, and is in this context called Primer One. The other primer which is only present in the liquid phase is named Primer Two. Buffer, nucleotides, template, Taq Polymerase, and both primers are then added to the liquid phase (but without 5'-end modifications) (Fig. 20).

The ratio in the liquid phase between Primer One and Primer Two is 1:8. Because of the higher concentration of Primer Two, the amplification will produce more products from this primer. This is called asymmetric amplification. The amplicons made from Primer Two will subsequently hybridize to the solid phase primers (Fig. 21). The solid phase primers will then be extended by Taq Polymerase progressing like any normal PCR, except that the extended primer is covalently bound to a solid phase. This creates PCR products which are covalently bound to the NucleoLink surface.

After amplification the system contains two types of amplicons: liquid phase amplicons which are removed and solid phase amplicons (Fig. 22).

The solid phase amplicons are double stranded. In order to detect them by hybridization they must be rendered single stranded. This is done by treatment with NaOH (Fig. 23).

The single stranded amplicons can now be detected by hybridization (Fig. 24). The detection probe is biotinylated, and a streptavidin conjugated enzyme is added. Finally, a colorimetric or fluorogenic substrate is added, and the amplicons are detected through the created color or fluorescent reaction which is measured in a plate reader.

Our in-house procedure for DIAPOPS can be found in Thermo Scientific Nunc Tech Note No. 36 'Thermo Scientific Nunc NucleoLink Procedure for Solid Phase PCR (DIAPOPS)'.

Fig. 19



Covalent binding of solid phase primer on the NucleoLink surface.

Fig. 22



Two types of amplicons: Liquid phase and solid phase amplicons.

Fig. 20



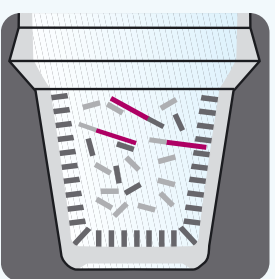
Addition of reagents including both primers to the liquid phase.

Fig. 23



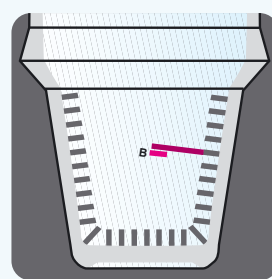
Denaturation of solid phase PCR product.

Fig. 21



Annealing of amplicons to solid phase primers.

Fig. 24



Detection by hybridisation.

### PCR-ELISA on NucleoLink

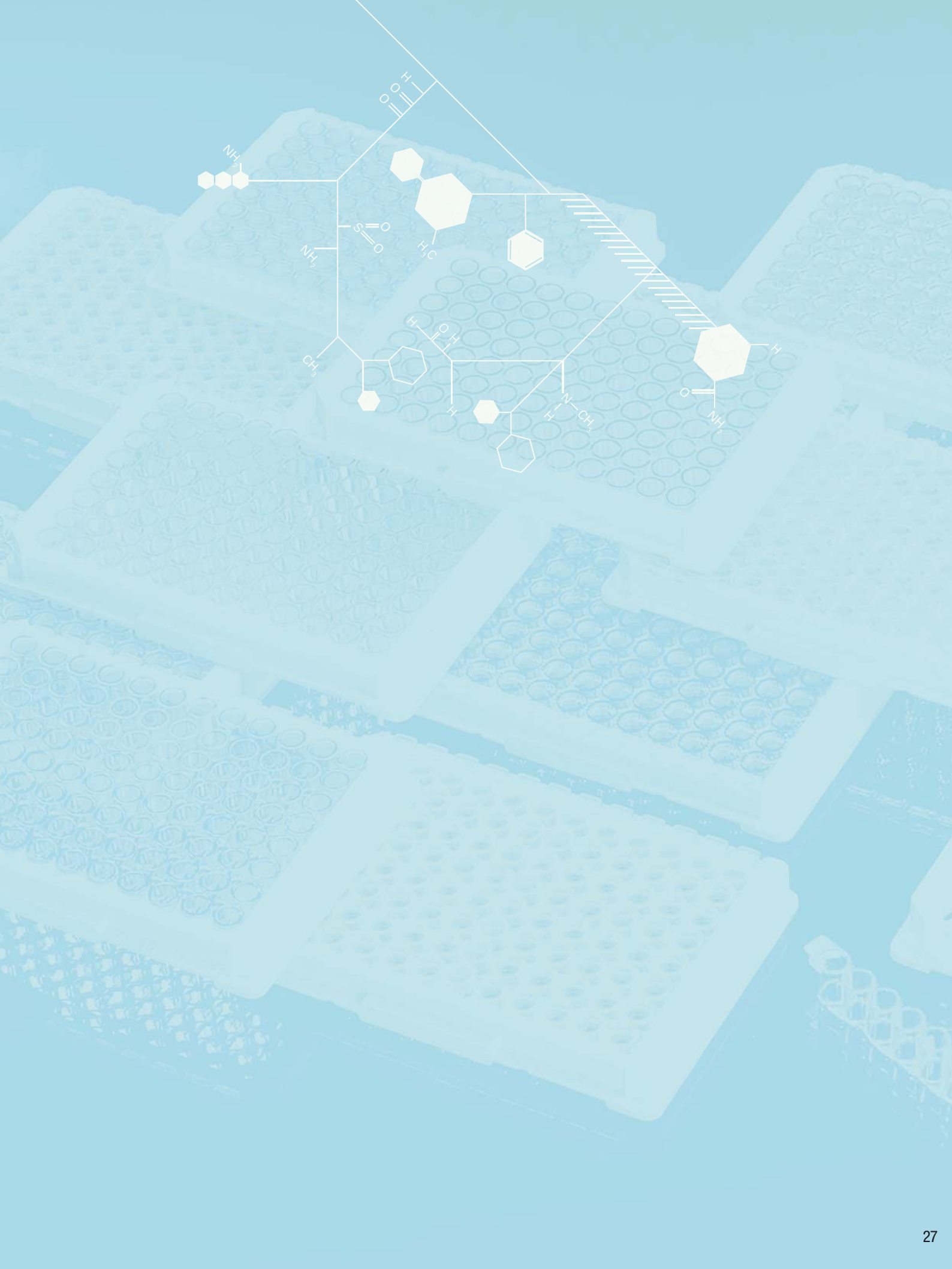
In PCR-ELISA a capture probe is covalently bound to the NucleoLink surface. PCR product labeled with biotin or digoxigenin (DIG) is added and hybridized to the capture probes. Hybridized PCR product labeled with biotin is detected by enzyme conjugated streptavidin while hybridized PCR product labeled with DIG is detected by enzyme labeled anti-DIG antibody. An appropriate substrate is added, and the results are measured on an ELISA reader or a fluorimeter.

The NucleoLink surface is especially well-suited for this kind of assay due to the high efficiency of covalent oligonucleotide binding. Since the immobilization of the capture probes is independent of streptavidin/biotin, expensive detection systems involving e.g. DIG/anti-DIG can be avoided. Instead streptavidin/biotin can be used in the detection of the immobilized PCR products. This gives an advantage compared to streptavidin coated plates on which biotinylated PCR products are captured.

Our in-house procedure for PCR-ELISA is appended in Appendix 5 - Hybridization Detection of PCR Products.

The NucleoLink strips are V-shaped with flat readable bottoms. The V-shape makes them compatible with thermal cyclers with 0.2mL V-shaped blocks, and the flat bottoms make it possible to read the results in MicroWell format readers.

Finally, the strips can be handled by equipment and multi-channel pipettes designed for MicroWell format.



# Glossary

## A

### Analyte

Compound which is to be measured in an assay.

### Antibody

Glycoprotein molecules produced by animal cell in response to the presence of foreign compounds.

### Antigen

Compound which is capable of eliciting an immune response in an organism.

### Anti-serum

Blood component containing antibodies to compounds.

## B

### Biomolecules

Biologically significant molecules, often macro-molecules.

### Blocker molecule

Molecule introduced in an assay to bind at excess sites in order to prevent undesired binding (non-specific binding).

## C

### Coating

A layer of molecules adsorbed on the surface of the assay container.

### Cross-reaction

Overlap in the recognition of antibodies and reagents which resemble the antigen.

## D

### Denaturation

The distortion and resultant disfunction of molecules especially biomolecules. DNA denaturation involves the separation of the two strands by heating or treatment with NaOH.

### DNA (Deoxyribonucleic Acid)

A polymer of nucleotides arranged on helical backbone of deoxyribose molecules each linked to one of four bases (two purines and two pyrimidines). Two helices are associated by the linking of the bases by hydrogen bonds between complementary pairs consisting of one pyrine and one pyrimidine. The sequence of the bases encodes genetic information and is found in complex chromosomes as in mammalian cells, simpler double stranded circles in bacterial chromosomes or as smaller circles or plasmids encoding less information and inherited independently by bacteria, bacteriophages and viruses.

## E

### Edge effect

An unexpected difference in the readings observed in the peripheral wells of the plate compared with otherwise identical wells in more centrally located wells. The effect is usually due to differences in temperature of the wells and is seen especially in assays conducted at high temperatures where the addition of reagents, possibly from cold containers, takes place at a lower temperature (e.g. assay incubation temperature 37°C, reagents stored at 4°C and added at 20°C).

### Enzyme conjugate

A synthetic compound produced by linking an enzyme to an antibody or part of an antibody which recognizes another molecule (e.g. antibody or antigen) to the animal in which it was raised.

### Epitope

A region of an anti-genic molecule which acts as a recognition site for an antibody. An epitope consists of a minimum of three amino acids, but most stable epitopes are often between five to seven amino acids.

### Experimental controls

A number of tests inserted in an assay in which a single element may be eliminated so that the result is predictable, e.g. analyte, blocker or other elements. The inclusion of such controls enables one to ascertain that the assay is working as it should. If any of the controls do not give the predicted result this can help to pinpoint the cause of the problem.

### Extension

In the PCR process the elongation of the DNA strands by the action of an enzyme (usually Taq polymerase). Nucleotides are added at the primers to single stranded free ends of the DNA template.

## G

### Gel diffusion assay

A system used to assay the presence and concentration of either an antibody or its antigen. A known concentration of one component is suspended in a gel. Wells are cut in the gel into which samples of the other component are placed. The component in the well is allowed to diffuse, and when the concentrations of the two components are equal, a complex is formed which is seen in the gel as a ring of precipitate.

**H****Hapten**

A small molecule which does not illicit an immune response. Anti-serum can be made to it if the hapten is linked to a larger immunogenic molecule. When this is used as immunogen, anti-serum specific for the hapten alone can be produced.

**Hybridization**

The alignment of the two strands of a DNA molecule accomplished by the correct pairing of a sequence of nucleotides.

**I****Immunoassay**

Assay methods the mechanism of which depends on principle of the antigen - antibody recognition system.

**L****Linker**

A small chain molecule, used to join two molecules, usually in order to allow space for interaction without steric hindrance.

**N****Neutral molecule**

A molecule used in an assay usually to prevent unwanted interactions. E.g. blocking molecules which bind at sites which otherwise might lead to high background. The molecules must be unrelated to molecules involved in the assay, and must not cross-react with other reagents.

**P****Polymerase Chain Reaction (PCR)**

The enzymic amplification of DNA by a thermal cycling program which permits the sequential hybridization, extension and denaturation for a predetermined number of cycles while precisely controlling a number of critical parameters.

**Q****Quenching**

The loss of measurable energy (signal) from a molecule in an excited state, due to collision or non-radiant energy transfer.

**S****Second antibody**

An antibody which recognizes proteins of the animal in which the first antibody was raised.

**Solid Phase**

A surface upon which an element of the assay can be immobilized in order to allow separation of the bound and free phases of the analyte when the quantification is to be made.

**Spacer arm**

A molecule which acts as a link between a surface and reagent molecule or hapten. The linker allows the hapten to be placed in a position where it is freely disposed to interact without steric hindrance.





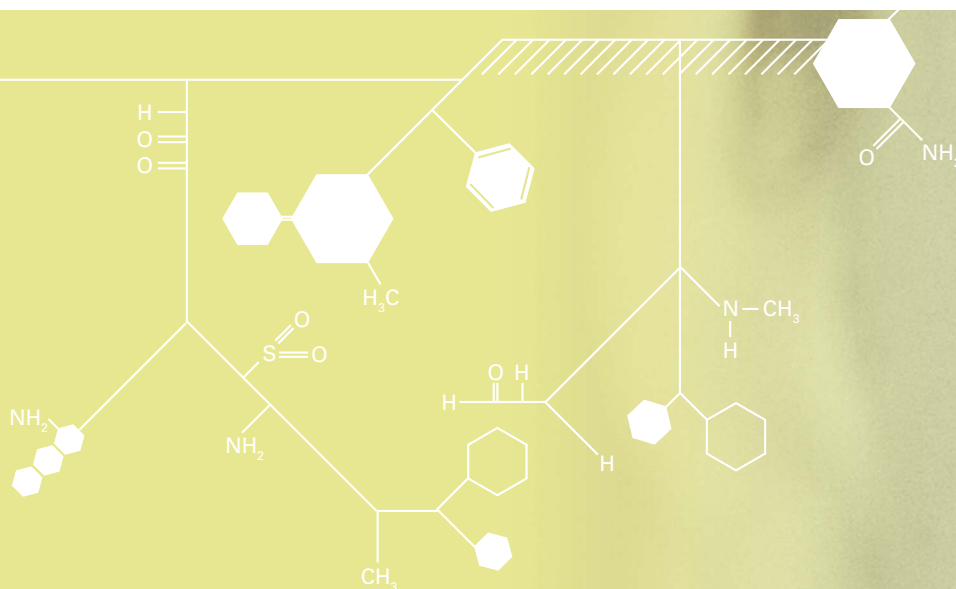
# Technical information index

## General

Bulletin No. 1	
Edge Effect in Thermo Scientific Nunc MicroWell ELISA.....	32
Bulletin No. 4	
Aspects of Thermo Scientific Nunc MicroWell Certification.....	38
Bulletin No. 6a	
Principles in Adsorption to Polystyrene.....	42
Bulletin No. 7a	
Comparison of Blocking Agents for ELISA.....	48
Bulletin No. 8	
Detergent in Polystyrene ELISA.....	51
Bulletin No. 9	
Blocking Agent and Detergent in ELISA.....	57
Bulletin No. 10b	
The Surface/Volume Ratio in Solid Phase Assays.....	61
Bulletin No. 11b	
Activity of Adsorbed Antibodies.....	66
Bulletin No. 12a	
Effects of Enlarged Surface / Volume Ratio in Solid Phase Assays.....	71
Bulletin No. 12b	
Comparison of Affinity-Isolated and Non-Isolated Antibodies Used as Capture Antibodies in ELISA.....	78

## Passive Adsorption

Bulletin No. 6b	
Stability of Thermo Scientific Nunc Immuno MaxiSorp Surfaces.....	82
Tech Note No. 6	
Thermo Scientific Nunc FluoroNunc Modules and Plates - The principle behind Q.C. procedure.....	84
Tech Note No. 10	
Performance of Thermo Scientific Nunc Immuno C8 StarWell.....	86
Tech Note No. 12	
Thermo Scientific Nunc FluoroNunc Plates and Modules: A Solid Phase for Fluorescent Immuno Assays.....	89
Tech Note No. 24	
In Situ Screening of Bacterial Colonies - Protocols.....	91
Tech Note No. 35	
High Sensitivity Detection of Antigens using Immuno PCR.....	93
Tech Note No. 58	
Thermo Scientific Nunc C8 White LockWell LumiNunc MaxiSorp and PolySorp for Luminescence Detection.....	95
Tech Note No. 59	
C8 Black Thermo Scientific Nunc LockWell FluoroNunc MaxiSorp and PolySorp for Fluorescence Detection.....	97
Tech Note No. 65	
Binding of Low Density Lipoprotein Particles to Human Aortic Proteoglycans in Enhanced Binding Thermo Scientific Microtiter Microplates.....	99
Tech Note No. 66	
Chemi-luminescent Alkaline Phosphatase Detection in White Clear Bottom Microplates.....	101
Tech Note No. 67	
Fluorometric Protein Quantitation in Black Microplates.....	103
Tech Note No. 68	
Multiserotype Enzyme-Linked Immunosorbent Assay using Thermo Scientific Microtiter Cliniplate.....	105



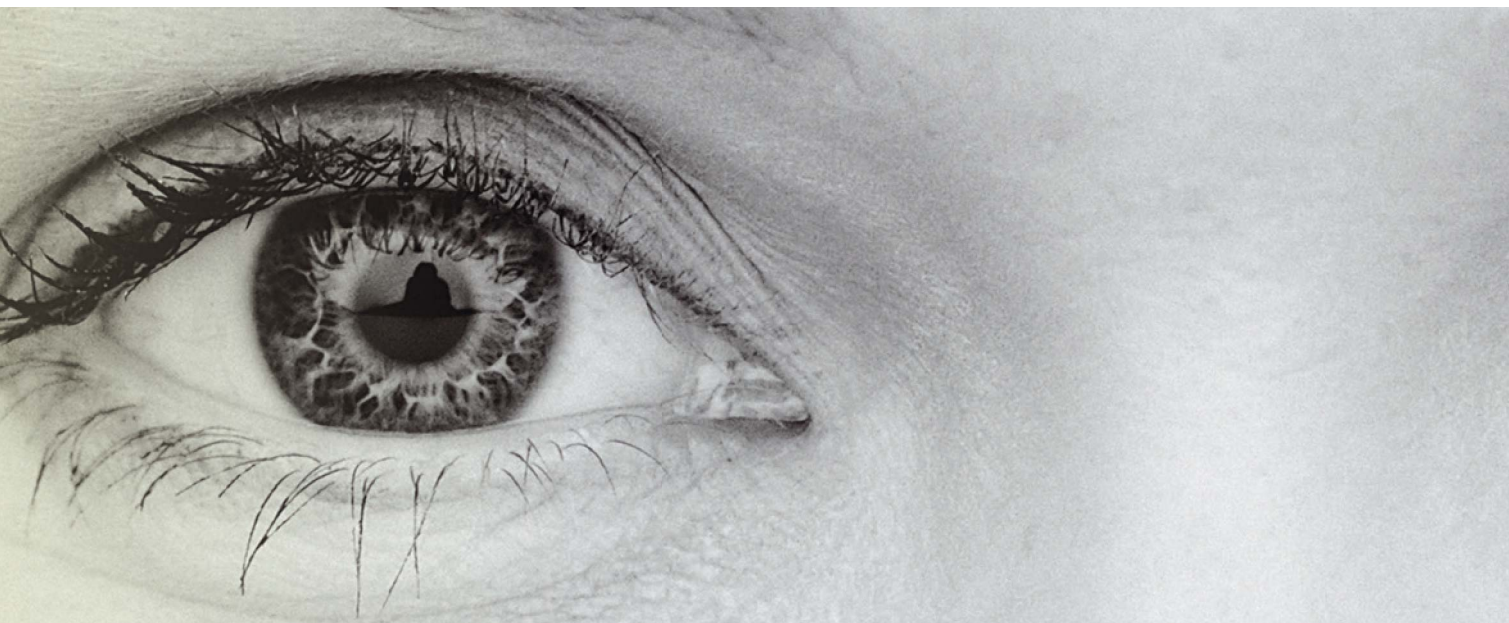


## Covalent Binding

Bulletin No. 10a	
Covalent Binding of DNA to Thermo Scientific Nunc	
CovaLink NH Methods and Applications .....	108
Tech Note No. 9	
Coupling of Oligosaccharides to Thermo Scientific Nunc	
CovaLink NH Modules.....	111
Tech Note No. 11	
DIAPOPS using Thermo Scientific Nunc CovaLink BreakApart Modules...	113
Tech Note No. 17	
Thermo Scientific Nunc NucleoLink versus CovaLink Surfaces.....	116
Tech Note No. 33	
Versatile PCR Assays Based on Hybridization in Thermo Scientific	
Nunc MicroWell Plates .....	118
Tech Note No. 36	
Thermo Scientific Nunc NucleoLink Procedure for Solid Phase PCR	
(DIAPOPS).....	120
Tech Note No. 37	
Thermo Scientific Nunc NucleoLink Procedure for PCR ELISA.....	123
Tech Note No. 43	
Thermo Scientific Nunc Immobilizer Amino Surface: Protocol	
for Coupling Proteins.....	125
Tech Note No. 56	
Custom-made Thermo Scientific Nunc Immobilizer for DNA Binding .....	127
Tech Note No. 64	
Thermo Scientific Nunc Immobilizer - Streptavidin and Amino.....	130

## Affinity Capture

Tech Note No. 34	
Streptavidin Coated Plates for Molecular Biology .....	132
Tech Note No. 41	
Thermo Scientific Nunc Immobilizer Streptavidin: Colorimetric	
detection of human IgG in blood plasma samples .....	134
Tech Note No. 42	
Thermo Scientific Nunc Immobilizer Streptavidin: PCR ELISA .....	136
Tech Note No. 44	
Thermo Scientific Nunc Immobilizer Glutathione .....	139
Tech Note No. 45	
Detection of Glutathione-S-transferase (GST) and GST-tagged	
Fusion (F-protein).....	141
Tech Note No. 46	
Thermo Scientific Nunc Immobilizer Nickel-Chelate .....	144
Tech Note No. 47	
Detection of His-tagged Fusion Proteins .....	146
Tech Note No. 63	
Thermo Scientific Nunc Immobilizer - Glutathione and Nickel-Chelate .....	149
Tech Note No. 69	
Thermo Scientific Microtiter Streptavidin Coated Microplates .....	151
Tech Note No. 70	
Thermo Scientific Microtiter Streptavidin Coated Microplates	
for PCR-ELISA.....	153



# Edge Effect in Thermo Scientific Nunc MicroWell ELISA

Peter Esser, M.Sc., Senior Scientist, Thermo Fisher Scientific

Sometimes with ELISA performed in a Thermo Scientific Nunc MicroWell plate unexpectedly higher (or lower) optical densities (O.D.) are measured in the peripheral wells than in the central wells. This phenomenon is called "edge effect".

The most probable causes of this effect are illumination or temperature differences between the peripheral and the central wells.

Light may cause edge effect if the substrate is photosensitive (i.e. converted by light exposure) like the H<sub>2</sub>O<sub>2</sub>/OPD substrate in the peroxidase system. Thus, if strong light is coming from one side (e.g. sunlight from a window) during the substrate reaction, the peripheral wells closest to the light source may give elevated O.D. values.

Temperature difference, however, is the most common cause of edge effect.

Incubation at 37°C instead of room temperature is often used for shortening incubation times due to the fact that at higher temperatures the dissolved molecules move faster and will therefore reach the well surface sooner than at lower temperatures.

However, a common mistake is to use reactant liquids straight from

a refrigerator and then incubate in a 37°C incubator (or at room temperature). Temperature changes of these magnitudes may, especially with short incubation times, destroy the assay homogeneity in Nunc™ MicroWell™ plates. The peripheral wells will normally be heated up first because of their position closest to the lower edge of the plate, which is in direct contact with the warm incubator shelf. Therefore, more reactant molecules may be immobilized in the peripheral wells, which may result in higher O.D. values in these wells, other things being equal.

The edge effect may be more pronounced if plates are stacked during incubation, especially in plates in the middle of the stack because their central wells are shielded from the warmer surroundings by the plates above and beneath.

To demonstrate a pronounced edge effect caused by temperature differences, a stack of 5 Thermo Scientific Nunc MaxiSorp plates with 4°C IgG:peroxidase conjugate, 200 µL per well, were incubated at 37°C for 30 minutes prior to substrate reaction. All the plates showed edge effect compared with a control plate with room

temperature conjugate incubated at room temperature. The most pronounced effect was observed in the second bottom plate, the results of which are given in Fig. 1.

Even if temperature changes are avoided, a small temperature dependent edge effect may remain, which can be disturbing in critical assays when incubation times are short. Due to heat consumption by evaporation (which is assumed to be equal from all the wells in uncovered plates), the wells will be cooled down. However, the heat loss will be restored faster in peripheral wells than in central wells, thus producing temperature differences and possibly edge effect.

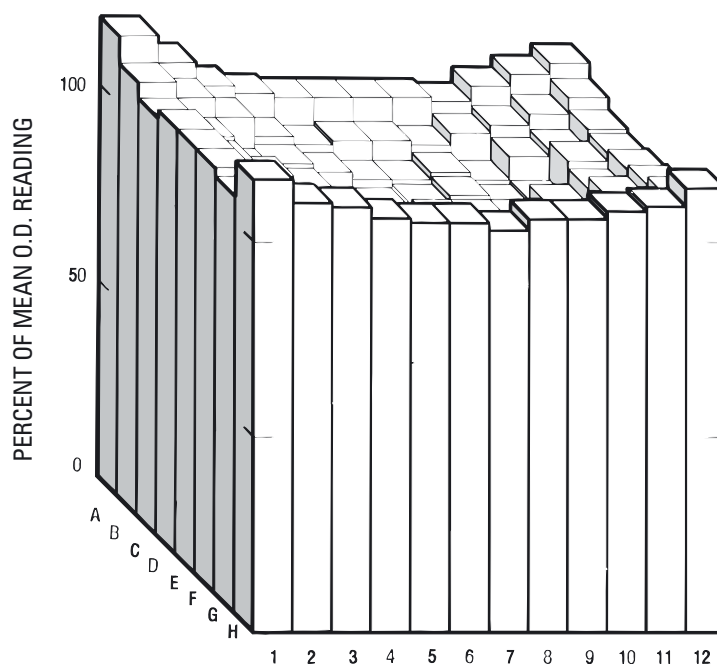
To avoid the above-mentioned problems, the following precautions should be taken:

1. Incubations should take place in subdued light or in the dark.
2. Reactant liquids (and plates) should be adjusted to the temperature intended for incubation.
3. Plates should be sealed with adhesive tape or placed in a 100% relative humidity environment during incubation.



**Fig. 1**

Block diagram of the plate O.D. readings from H<sub>2</sub>O<sub>2</sub>/OPD substrate reactions in a MicroWell plate illustrating the edge effect after incubation with 4°C IgG:peroxidase conjugate at 37°C for 30 minutes. Each column represents the O.D. reading of the respective well in percent of the plate mean value (952 mEU). Note that the edge effect is most pronounced in the corner wells, A1 giving the maximum value = 118%, while the central well D6 gives the minimum value = 89%. See text for further explanation.



## Adsorption Geometry for Solid Phase Assays

For optimal set-up of a solid phase assay it is essential to know the dimensional relationship between the “solid phase products” and the volumes of liquid.

Table 1 lists the geometric figures that correspond to certain volumes of liquid in Thermo Scientific Nunc solid phase products.

The size of the plastic area covered with liquid reflects the total binding capacity with that particular combination of vessel and volume of liquid and thus the total amount of e.g. IgG needed for a saturated coating of the surface covered.

The liquid height figures can be used to estimate the available free volume for possible addition of extra liquid (e.g. sulphuric acid for stopping the color reaction in ELISA) and to estimate the optimal thickness of the developed color layer (in MicroWell assays) when measured in a photometric MicroWell reader. In tube assays the final liquid height must be above the level of the transverse measuring light beam in the applied tube reader.

The area/volume ratio reflects the amount of reactant molecules that can be bound per mL of liquid used.

The higher the ratio is, the more molecules can be bound per mL liquid.

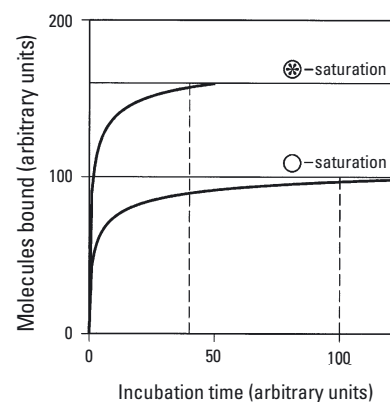
Using the plausible estimate that the surface can adsorb 400 ng IgG per cm<sup>2</sup>, the approximate concentration *S* needed for saturation can be calculated from the area/volume ratio *R*:  $S = 0.4 \times R$  µg IgG per mL.

For coating the TSP, the adsorption by the vessel into which the TSP is dipped should also be taken into consideration.

The ratio is also a relative measure of the mean distance that the dissolved reactant molecules have to travel to reach the solid phase and thus of the time needed for the molecules to be bound. In general, the higher the ratio is, the shorter the distance and the incubation time needed will be. The benefits of a high area/volume ratio prompted us to develop the Thermo Scientific Nunc Immuno StarTube with 6 fins in the bottom of the tube, thus increasing the area/volume ratio considerably

compared to an ordinary tube. The relative increase is dependent on the volume of liquid added, i.e. the smaller the volume, the larger the increase.

Fig. 2 illustrates the favorable effects of the increased area/volume ratio when using the StarTube.

**Fig. 2**

Average adsorption curves showing the increase in number of bound molecules and the decrease in incubation time obtainable with 350 µL reactant volume by use of the 75x12 mm StarTube (⊗), compared to the ordinary 75x12 mm standard tube (○). The mutual relationship between these curves holds for the binding of every successive layer in the immuno assay sandwich.

**Table 1**

Corresponding figures relevant for designing solid phase assays in Thermo Scientific Nunc products.

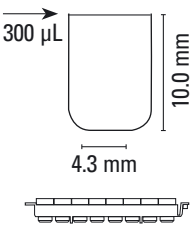
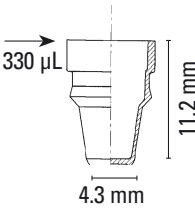
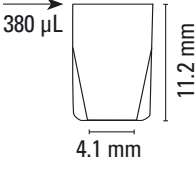
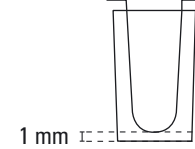
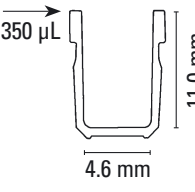
Product	Liquid volume, $\mu\text{L}$	Covered area, $\text{mm}^2$	Liquid height, mm	Area/volume ratio, $\text{cm}^2/\text{cm}^3$
<b>Nunc BreakApart Modules, C8</b>				
	250	190	8.5	7.6
	200	159	6.9	7.9
	175	143	6.1	8.2
	150	127	5.2	8.5
	125	110	4.4	8.8
	100	94	3.5	9.4
	75	78	2.7	10.4
	50	61	1.8	12.2
<b>Nunc NucleoLink Modules</b>				
	330	234	11.2	7.1
	200	159	8.1	7.9
	100	96	5.2	9.6
	50	57	2.4	11.4
	25	37	1.6	14.8
<b>Nunc StarWell Modules, C8</b>				
	250	23	7.7	9.0
	200	198	6.3	9.9
	175	193	5.7	11.0
	150	166	4.9	11.0
	125	146	4.2	11.7
	100	125	3.4	12.5
	75	100	2.6	13.3
	50	72	1.8	14.4
<b>Nunc TSP in MicroWell F</b>				
	250	95	9.7	3.8
	200	75	7.6	3.8
	150	53	5.6	3.5
	125	41	4.6	3.3
	100	29	3.5	2.9
	75	20	2.8	2.4
	50	9	1.8	1.8
	50	55	3.4	11.0
<b>Nunc LockWell Modules, C8</b>				
	250	188	7.9	7.5
	200	157	6.4	7.8
	175	141	5.6	8.1
	150	126	4.8	8.4
	125	110	4.0	8.8
	100	94	3.2	9.4
	75	78	2.4	10.4
	50	62	1.6	12.5

Table 1 (cont'd.)

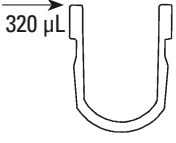
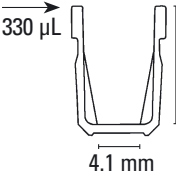
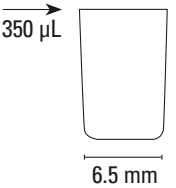
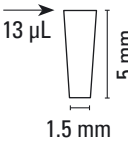
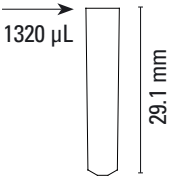
Product	Liquid volume, $\mu\text{L}$	Covered area, $\text{mm}^2$	Liquid height, mm	Area/volume ratio, $\text{cm}^2/\text{cm}^3$
<b>Nunc LockWell Modules, U8</b>				
	250	178	8.6	7.1
	200	147	7.1	5.9
	175	132	6.3	7.5
	150	116	5.6	7.7
	125	101	4.8	8.0
	100	85	4.0	8.5
	75	69	3.2	9.2
	50	53	2.5	10.7
<b>Nunc LockWell StarWell Modules, C8</b>				
	250	244	8.4	9.8
	200	213	6.9	10.7
	175	196	6.2	11.2
	150	177	5.4	11.8
	125	156	4.5	12.5
	100	132	3.7	13.2
	75	105	2.8	14.0
	50	75	1.9	15.1
<b>Nunc MicroWell Modules, C8, C12</b>				
	250	185	8.3	7.4
	200	154	6.7	7.7
	150	122	5.1	8.1
	125	106	4.3	8.5
	100	90	3.5	9.0
	75	73	2.7	9.7
	50	56	1.8	11.2
<b>Nunc 1536 Well Plates</b>				
	12	32	4.6	26.7
	10	27	3.9	27.3
	8	23	3.2	28.0
	6	18	2.4	29.3
	4	113	1.6	31.5
	2	8	0.9	37.3
	1	5	0.5	47.2
<b>Nunc 96 DeepWell Plates 1.0 mL</b>				
	1200	649	26.9	5.4
	1000	553	23.2	5.5
	800	453	19.2	5.7
	600	350	15.1	5.8
	400	245	10.7	6.1
	200	138	6.1	6.9
	100	84	3.7	8.4

Table 1 (cont'd.)

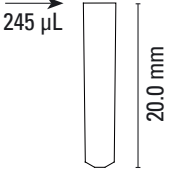
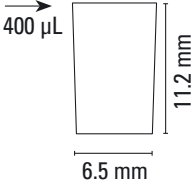
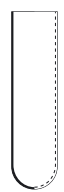
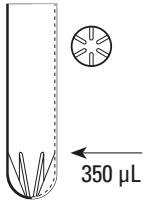
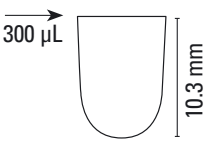
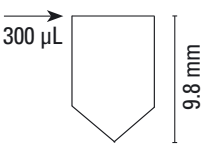
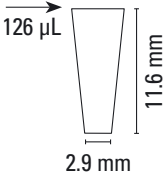
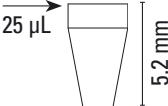
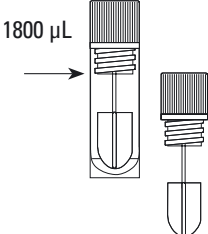
Product	Liquid volume, $\mu\text{L}$	Covered area, $\text{mm}^2$	Liquid height, mm	Area/volume ratio, $\text{cm}^2/\text{cm}^3$
<b>Nunc 384 DeepWell Plates</b>				
	225	244	18.1	10.9
	200	220	16.4	11.0
	150	168	12.7	11.2
	125	142	10.8	11.4
	100	116	8.8	11.6
	50	62	4.7	12.4
	25	35	2.6	14
<b>Nunc MicroWell Plates and Modules, F96, F16, F8</b>				
	250	184	7.3	7.4
	200	154	5.9	7.7
	150	124	4.5	8.3
	125	109	3.8	8.7
	100	94	3.0	9.4
	75	79	2.3	10.5
	50	63	1.5	12.6
<b>Nunc Immuno Tube 70 x 11</b>				
	1500	760	27.0	5.1
	1000	520	18.4	5.2
	750	400	14.0	5.3
	500	280	9.5	5.4
	300	160	6.1	5.5
	250	140	5.6	5.6
	1	5	0.5	47.2
<b>Nunc Immuno Tube 75 x 12 (StarTube 75 x 12)</b>				
	1500	695 (815)	24.4 (25.5)	4.6 (5.4)
	1000	480 (600)	16.9 (18.0)	4.8 (6.0)
	500	260 (380)	9.3 (10.4)	5.2 (7.6)
	350	195 (315)	7.0 (7.6)	5.6 (9.0)
	300	175 (290)	6.2 (6.8)	5.8 (9.7)
	250	155 (260)	5.4 (5.8)	6.2 (10.4)
<b>Nunc MicroWell Plates and Modules 0.30 mL, U96, U16, U8</b>				
	250	175	8.7	7.0
	200	145	7.2	7.3
	150	115	5.7	7.7
	125	100	5.0	8.0
	100	85	4.2	8.5
	75	68	3.4	9.1
	50	52	2.6	10.4
<b>Nunc MicroWell Plates 0.30 mL, V96</b>				
	250	177	9.2	7.1
	200	147	7.8	7.3
	150	117	6.4	7.8
	125	101	5.6	8.1
	100	86	4.9	8.6
	75	71	4.1	9.4
	50	55	3.4	11.0

Table 1 (cont'd.)

Product	Liquid volume, $\mu\text{L}$	Covered area, $\text{mm}^2$	Liquid height, mm	Area/volume ratio, $\text{cm}^2/\text{cm}^3$
<b>Nunc 384 Well Plates</b>				
	110	144	10.5	13.1
	100	133	9.7	13.2
	80	110	8.0	13.7
	60	86	6.3	14.3
	40	61	4.4	15.3
	20	36	2.3	17.6
	10	32	1.2	21.9

Product	Liquid volume, $\mu\text{L}$	Covered area, $\text{mm}^2$	Liquid height, mm	Area/volume ratio, $\text{cm}^2/\text{cm}^3$
<b>Nunc Shallow Well Plates</b>				
	22.5	38.5	4.8	17.1
	20.0	35.5	4.5	17.6
	15.0	28.6	3.8	19.1
	12.5	25.2	3.4	20.2
	10.0	21.5	3.0	21.5
	5.0	13.0	1.9	26.0
	2.5	7.8	1.1	31.2

Product	Volume in tubes, $\mu\text{L}$	Paddle area covered	Liquid height on paddle, mm	Area/volume $\text{cm}^2/\text{cm}^3$
<b>Nunc Immuno Stick</b>				
	1000	520	8.5 (0.7)	5.2
	500	335	10.5 (0.7)	6.7
	250	176	6.2 (0.7)	7.0

[www.thermoscientific.com/oemdiagnostics](http://www.thermoscientific.com/oemdiagnostics)

© 2010 Thermo Fisher Scientific Inc. All rights reserved.  
 All trademarks are the property of Thermo Fisher Scientific Inc. and its subsidiaries.

# Aspects of Thermo Scientific Nunc MicroWell Certification

Peter Esser, M.Sc., Senior Scientist, Thermo Fisher Scientific

We certify the adsorption capability of Thermo Scientific Nunc MediSorp and MaxiSorp MicroWells F, U, C, and StarWell on the basis of the following test procedure (where the reagent volumes apply to F-wells, other well types using volumes proportionally adjusted to their respective contents).

1. Add to an 8 x 12 Nunc™ MicroWell™ matrix antibody coating mixture consisting of 10 µg rabbit IgG (Dako X 0903) and 65 ng rabbit IgG:HRP conjugate (Dako P 0128) per mL 0.05 M carbonate buffer, pH 9.6, 200 µL/well.
2. Seal with adhesive tape and incubate overnight in the dark at room temperature.
3. Wash 3 times (Nunc StarWell™ 5 times) with 0.15 M PBS, pH 7.2, containing an extra 0.2 M NaCl and 0.05% Triton X-100.
4. Add substrate solution consisting of 0.6 mg OPD-2HCl (Sigma P-1526) and 0.5 µL 30% H<sub>2</sub>O<sub>2</sub> per ml 0.1 M phosphate-citrate buffer, pH 5.0, 200 µL/well.
5. Stop substrate reaction after 3.5-4 min. by adding 2N H<sub>2</sub>SO<sub>4</sub>, 150µL/well.
6. Read O.D. (Optical Density) at 490 nm against air in a MicroWell reader. U-wells are also read at 620 nm as a reference in order to eliminate any possible non-uniform

extinction due to light refraction in the bottom curvatures.

Consequently, dual wavelength reading is recommended in any assay using U-wells.

7. Calculate the C.V. (Coefficient of Variation) for the O.D. readings of the 8 x 12 MicroWell matrix according to the following formula:

$$C.V. = S \cdot \frac{100\%}{X} = \sqrt{\frac{\sum (X-X)^2}{N-1}} \cdot \frac{100\%}{X}$$

where: S = standard deviation of O.D. readings  
 X = mean of O.D. readings  
 X = individual O.D. readings  
 N = number of readings (wells)

This expression for S is equivalent to:

$$\sqrt{\frac{\sum (X^2) - \frac{1}{N} (\sum X)^2}{N-1}}$$

The C.V. is a measure of the variation of the O.D. values between the wells in the matrix, and it is used as a measure of the adsorption uniformity between the wells. The smaller the C.V., the more uniform the adsorptive performance of the wells, all experimental uncertainties being equal.

According to the above procedure Nunc MediSorp™ and Nunc MaxiSorp™ certification guarantees a C.V. of less than 5% for an 8 x 12 well MicroWell matrix. However, as can be seen

from Fig. 1, the 5% criterion does not necessarily exclude the possibility of some wells having large deviations from the mean O.D. For example, if just one well deviates, the deviation may reach almost 50% without invalidating the 5% C.V. requirement. Therefore, another criterion for certification was included: The O.D. reading of any well must be within +/- 10% from the mean. From Fig. 1 it can be seen that these criteria in concert imply that 24 wells with a 10% deviation is the (theoretical) upper limit for product acceptance.

Of course, the fulfilment of the criteria not only assumes certain qualities of the wells per se, but also adequate technical skill, which involves a »human factor variable« to be considered in the matter of C.V. reproducibility.

However, at very low and very high O.D. values, inevitable experimental uncertainties may cause the C.V. to exceed 5%, as demonstrated by the results in (Fig. 2).

At low O.D. values minor interwell dissimilarities in substrate conversion, liquid volumes, measuring beam alignment, etc. will cause reading deviations which are large compared to the measured values thus resulting in a large C.V. Also at high O.D. values such dissimilarities will cause relatively large reading deviations due to the very steep course of the extinction curve at the upper extreme (Fig. 3).

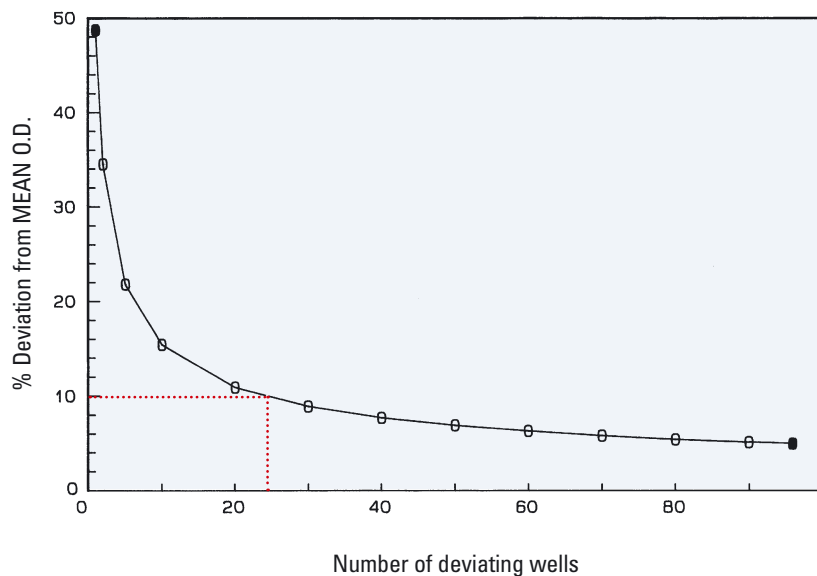


Fig. 1

Curve showing the number of wells, with a definite deviation from the mean O.D., required to produce a C.V. of 5% assuming that the remaining wells in the 8 x 12 matrix have zero-deviation. The dotted lines indicate 24 wells with 10% deviation as the upper limit for product acceptance. This curve was calculated from the C.V. formula given in the text.

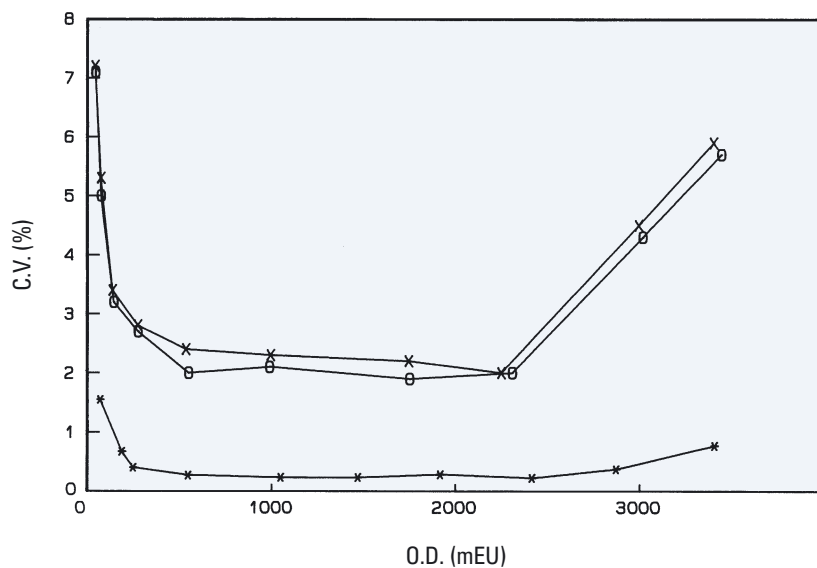


Fig. 2

C.V. of two 8 x 12 F-well matrices (X and O) at various O.D. values demonstrating C.V. elevations beyond the 5% acceptance level at the O.D. extremes. The curves were obtained by varying the amount of conjugate in the coating mixture while maintaining a constant substrate reaction time of 3.5 minutes. It should be noted that the same O.D./C.V. correlation was obtained by varying the substrate reaction time and keeping the amount of conjugate constant. This excludes the possibility of significant influence from conjugate dilution.

The bottom curve (\*) represents the C.V. due to photometric reading uncertainty alone which is also elevated at the O.D. extremes thus contributing to the total C.V. elevations. This curve was produced by calculating the C.V. from 12 measurements of the same well. This was done at various O.D. values obtained through appropriate dilutions of converted substrate in an 8 x 12 F-well matrix, one column with each dilution. Each C.V. is the mean from 8 consecutive measurements in a column made by each detection channel in the MicroWell reader.

See text for further explanation.

Therefore, for the quality control, the O.D. mean is maintained between 1200 and 1300 mEU, which is in the middle of the constant C.V. range as it appears from Fig. 2. This may be adjusted by the substrate reaction time, which is generally in the area of 3.5-4 minutes using Dako standard conjugate preparations.

The influence of the substrate reaction time on C.V. has been checked, and the results are shown in Fig. 4. It is apparent that for reaction times longer than one minute, including the 3.5-4 minutes' range, the C.V. remains almost constant at a minimum of about 2%.

Part of the C.V. is due to photometric reading uncertainty, which means that the total C.V. includes the variation inherent in re-measuring one well 96 times.

The MicroWell reader here applied had 8 parallel detection channels, one for each well in a column. Assuming the same reading uncertainty on each channel, the C.V. due to this uncertainty alone has been determined at various O.D. values. It appears from the results shown in Fig. 2 that the elevated C.V. at extreme O.D. values is partially the result of enlarged reading uncertainties at the extremes. This is due to the limitations in photometric performance.

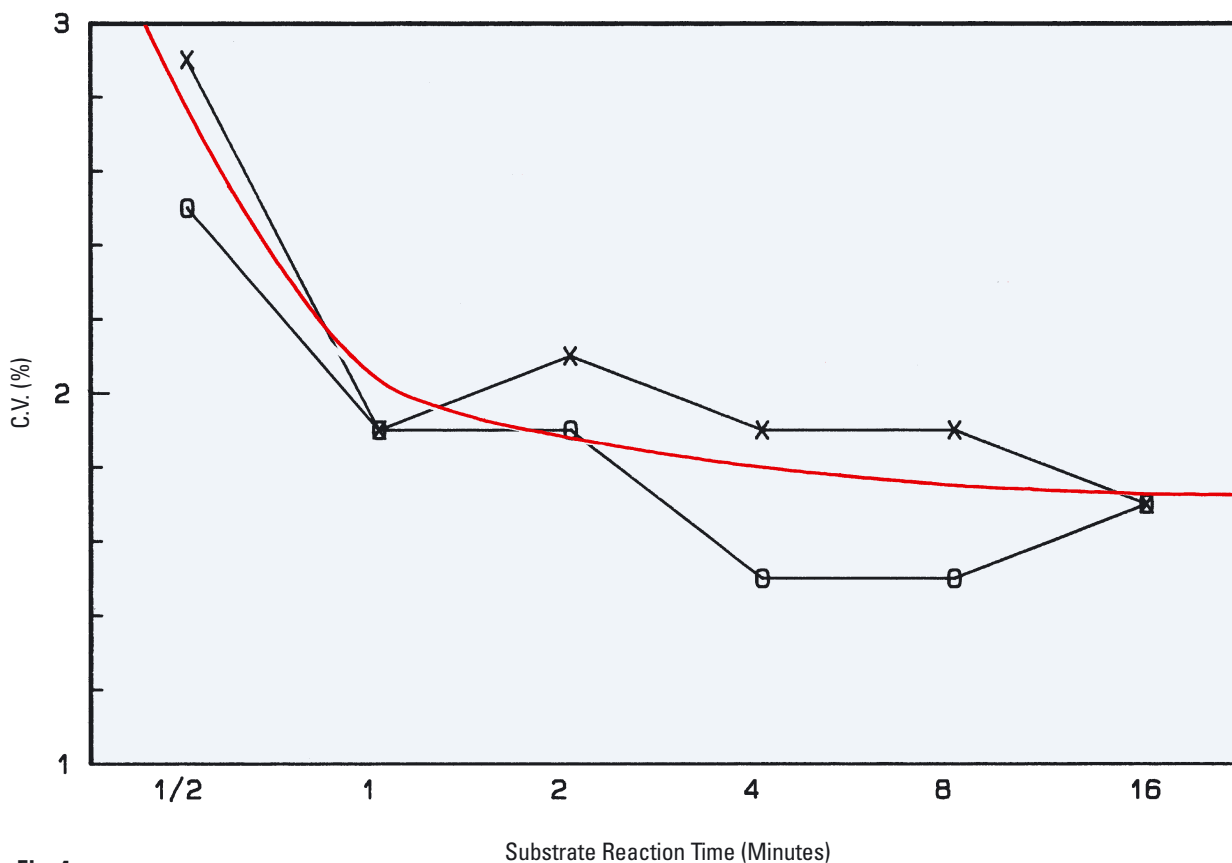
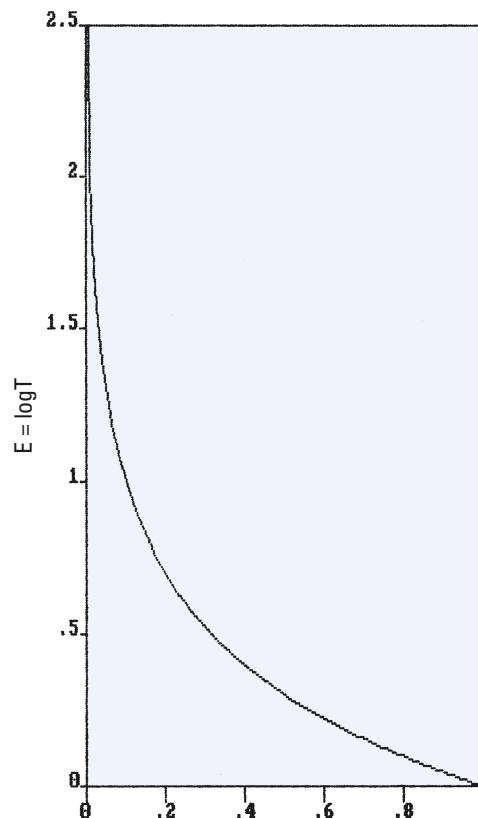
A low O.D. value is measured by the ratio between two relatively large light intensities (from sample and blank), which implies a relatively large uncertainty. A high O.D. value is the result of very little transmitted light, which also implies enlarged uncertainty because the photometric sensitivity becomes inadequate.

Although not determined in this connection, possible calibration inaccuracies between the detection channels will also contribute to the total C.V.

In conclusion, for reproduction of the claimed qualities of MaxiSorp MicroWell products, one should observe the following precautions:

1. Use well-defined, standardised chemicals.
2. Keep the O.D. within the 1000-1500 mEU range.
3. Use sufficiently long substrate reaction times (but be sure that the substrate conversion has not levelled off).
4. Secure optimal photometer performance.
5. Use dual wavelength reading for U-wells.
6. Use adequate technical skill.

**Fig. 3**  
 The relationship between photometric light transmission, T, expressed as the ratio between the light passing through the sample and through the blank, and extinction, E, according to the definition:  
 $E = -\log_{10}T$ . One extinction unit, EU, is the extinction when  $T = 0.1$ , two EU the extinction when  $T = 0.01$ , etc. Optical density, O.D., is most conveniently displayed in EU (or mEU), because this figure is directly proportional to sample concentration according to the Lambert-Beer law. Note the very steep course of the curve when extinctions exceed 2 EU.



**Fig. 4**  
 C.V. of two 8 x 12 F-well matrices (X and O) for various substrate reaction times demonstrating that already beyond one minute, the C.V. has decreased to a minimum, leaving the routinely used 3.5-4 minutes well within the minimum range. The curves were obtained by proportionally varying the amount of conjugate and substrate reaction time while maintaining the O.D. within the preferred 1200-1300 mEU range. The red curve is an average curve, adapted by eye.



## Negative Edge Effect in Thermo Scientific Nunc MicroWell ELISA

In Thermo Scientific Nunc Bulletin No. 1 circumstances which can cause positive edge effect were discussed.

Here we will discuss negative edge effect, i.e. unexpectedly lower optical densities in peripheral wells than in central wells of a Thermo Scientific Nunc MicroWell matrix, due to temperature differences.

If, during some incubation in ELISA, one of the six conditions listed in Table 1 occurs, an edge effect of the corresponding sign (positive or negative) may be observed. It appears from Table 1 that the sign of the edge effect is dependent on the relative temperature of the surroundings, negative edge effect being the case when the surroundings are colder than the reactant liquids and/or the wells per se. An exception would be in "competitive" ELISA, where sample and labelled standard are incubated successively, starting

with the sample. In this case relatively cold surroundings would give positive edge effect and vice versa.

Whereas positive edge effect easily occurs due to the short incubation time normally used in warm incubations (37°C), negative edge effect will be blurred due to the long incubation time normally used in cold incubations (4°C). Therefore, negative edge effect is a less common, or at least less pronounced, phenomenon than positive edge effect.

However, if negative edge effect is observed or suspected in an assay, one should always consider the causative conditions listed in Table 1.

If one of these conditions occurs during a brief substrate reaction, the negative edge effect may be expressed rather easily. Especially, this is likely to occur if the incubation prior to substrate

reaction is a relatively warm one, which may establish the last case mentioned in Table 1.

To demonstrate the negative edge effect in this case, a Thermo Scientific Nunc Immuno Plate MaxiSorp F96 was incubated with 200 µL/well of IgG:peroxidase conjugate at 37°C for two hours (plate and conjugate were both preheated to 37°C), immediately followed by quick washings (within one minute) and H<sub>2</sub>O<sub>2</sub>/OPD substrate reaction for 3.5 minutes at room temperature. The plate showed negative edge effect, as illustrated in Fig. 5, compared with a plate which had been adjusted to room temperature before substrate reaction.

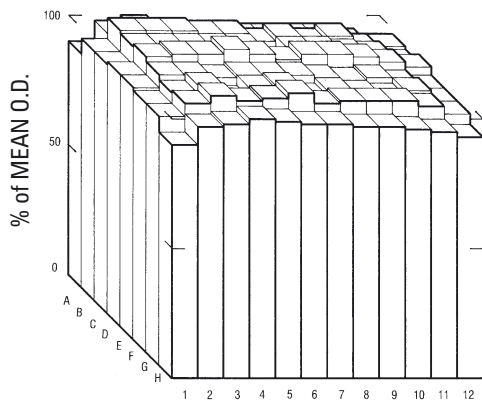
Obviously, to eliminate edge effects, not only the reactant liquid should be adjusted to the temperature intended for incubation, but also the wells per se.

### Relative temperature of

Reactant Liquid	Wells	Surroundings (Incubator)	Sign of Edge Effect
Cold	Cold	Warm	+
Cold	Warm	Warm	+
Warm	Cold	Warm	+
Warm	Warm	Cold	-
Warm	Cold	Cold	-
Cold	Warm	Cold	-

**Table 1**

Dependence of edge effect sign on temperature conditions during (at the beginning of) incubation.



**Fig. 5**

Block diagram of the O.D. readings from H<sub>2</sub>O<sub>2</sub>/OPD substrate reactions in a MicroWell plate illustrating the edge effect after incubation with IgG:peroxidase conjugate at 37°C for two hours. Each column represents the O.D. reading of the respective well in percent of the plate mean value (1064 mEU). Note that the edge effect is most pronounced in the corner wells, A1 and H12 giving the minimum value = 90%, whereas the central well D5 gives the maximum value = 107%. See text for further explanation.

[www.thermoscientific.com/oemdiagnostics](http://www.thermoscientific.com/oemdiagnostics)

© 2010 Thermo Fisher Scientific Inc. All rights reserved. "Dako" is a registered trademark of Dako Denmark A/S and "Triton" is a registered trademark of Dow Chemical Company. All other trademarks are the property of Thermo Fisher Scientific Inc. and its subsidiaries.

# Principles in Adsorption to Polystyrene

Peter Esser, M.Sc., Senior Scientist, Thermo Fisher Scientific

When considering the binding capacity of adsorbant plastic surfaces for biomacro-molecules, one must distinguish between the total amount of molecules that can be bound to the surface and the amount that can be bound and still remain biologically active. Both quantities are very much dependent on the nature of the molecules and the character of the surface.

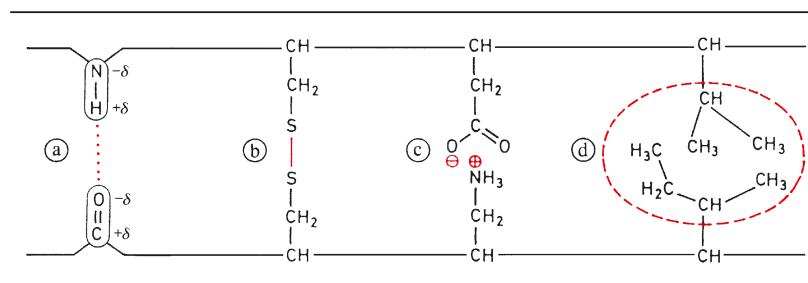
## Adsorption Forces

The adsorption of molecules to a polystyrene surface is due to intermolecular attraction forces (van der Waals forces), to be distinguished from »true« chemical bonds, i.e. covalent bonds (through electron share) and ionic bonds (through stoichiometric charges of opposite signs) (see Fig. 1). Intermolecular attraction forces are based on intramolecular electric polarities of which two types can be distinguished: alternating polarities (AP) and stationary polarities (SP), i.e. dipoles.

AP arises when molecules approach each other, thereby creating disturbances in each other's electron clouds. This causes synchronously alternating polarities in the molecules, which may establish a bond between them, as illustrated in Fig. 2.

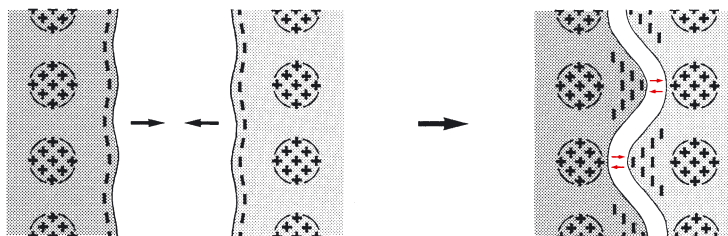
AP mediated binding is a common substance property, which is obviously the stronger, the larger the molecules implied. This is demonstrated by the fact that melting and boiling points increase with number of carbon atoms in the non-polar hydrocarbon series.

Indeed, it is due to this force that non-polar molecules at all aggregate into liquids and solids.



**Fig. 1.**

The four main types of possible bonds between macromolecules. »True« chemical bonds are represented by a covalent disulphide bond (b) and an ionic bond between a carboxyl ion and an amino ion (c). Van der Waals mediated bonds are represented by a hydrogen bond between two dipoles (a) and an alternating polarity bond between hydrocarbon residues protruding from the macromolecules' backbones (d), where the encircled area indicates a water-deprived zone. See text for further explanation.



**Fig. 2.**

Schematic illustration of how synchronously alternating polarities (AP), created by reciprocal electron cloud disturbances in approaching molecules, can establish a bond between the molecules. Transient, minus-charged electron cloud condensations in one molecule will attract reciprocally exposed, plus charged nuclear regions in the other molecule.

In addition to the AP attraction forces, molecules may possess SP (stationary polarity) through which they can bind to each other simply by bedding dipole against dipole, as illustrated in Fig. 1a.

Compared with SP, AP attraction decreases drastically with increasing distance between the molecules. Thus, AP attraction is inversely proportional to the seventh power of the distance, former has a much shorter range than the latter.

In general, van der Waals mediated bonds are about 100 times weaker than ionic and covalent bonds. However, among SP mediated bonds the hydrogen bond takes up an exceptional position because it is up to 10 times stronger than the others and because of its crucial importance for the properties of water and for the specific behaviors of bio-molecules.

Chemical groups, which can take part in hydrogen bonding, in particular  $-OH$ ,  $=O$ ,  $-NH_2$ ,  $=NH$ ,  $\equiv N$ , are called hydrophilic, as opposed to hydrophobic groups lacking this ability. Accordingly, hydrogen bonds may be called hydrophilic bonds, as opposed to AP mediated bonds, which are called hydrophobic bonds. The AP mediated attraction is also called hydrophobic interaction.

### Adsorbing Surfaces

The Thermo Scientific Nunc Immuno program comprises different types of adsorbent polystyrene surfaces, including the Thermo Scientific Nunc PolySorp and MaxiSorp surfaces. While Nunc™ PolySorp™ predominantly presents hydrophobic groups, MaxiSorp™ has in addition many hydrophilic groups, which results in a fine patchwork of hydrophobic and hydrophilic binding sites. In aqueous medium, a repelling effect exists between the PolySorp surface and hydrophilic macromolecules (i.e. rich in hydrophilic groups), because these molecules will rather tend to intermingle with the water molecules (i.e. be dissolved) by the strong hydrogen bonds than bind to the surface by the weak hydrophobic bonds.

On a MaxiSorp surface, however, adsorption of hydrophilic macromolecules will be greatly facilitated, because not only can this surface compete with the water molecules for binding the macromolecules by hydrogen bonds, but the molecules can also be captured from a much longer distance by the long-range hydrogen bond forces for establishment of both hydrogen bonds and eventually hydrophobic bonds (see Fig. 3).

On the other hand, hydrophobic macro-molecules (i.e. deficient in or lacking hydrophilic groups) can only be loosely adsorbed to MaxiSorp, because this surface tends to bind water molecules by hydrogen bonds, against which the macromolecules cannot compete and therefore

exhibit poor ability for displacing water molecules and hydrophobic adsorption free from water pocket interruptions.

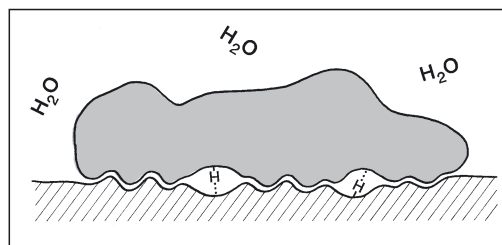
On a PolySorp surface, however, no hindrance exists for stable hydrophobic adsorption of hydrophobic molecules, except that they may not be applicable in purely aqueous medium, wherefore addition of or substitution with detergent or organic solvents (e.g. ethanol or hexane) may be needed.

In summary, when no attention is paid to maintenance of specific activities, hydrophobic compounds bind preferably to PolySorp, and hydrophilic compounds preferably to MaxiSorp (see Table 1). However, with MaxiSorp binding events are more likely to occur, which means that adequate incubation conditions are more easy to establish – a fact that may extend the MaxiSorp application range well into the theoretical

PolySorp domain. Nevertheless, considering the maintenance of the specific activities of the molecules (e.g. enzymatic, immunologic), which of course is crucial, the specific sites may well be obscured, impaired or destroyed through the binding to the surface.

Therefore, when constructing a solid phase assay, it is generally recommended to try adsorption to MaxiSorp first. If this does not work satisfactorily, it may be due to molecular malfunction, and one should then try PolySorp whereby specific activities may be maintained because of the different binding mechanism to this surface.

However with PolySorp, where molecules must come very close to the surface to establish hydrophobic bonds, one must anticipate more demanding incubation conditions, such as higher reactant concentration, longer duration, higher



**Fig. 3**

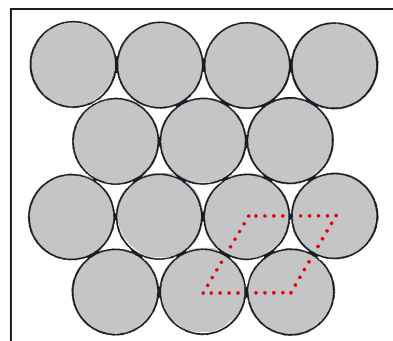
Schematic illustration of how a hydrophilic macromolecule can be firmly adsorbed to MaxiSorp by »squeezing« out the water between the molecule and the surface through the combined action of hydrogen bond and AP bound forces. See text for further explanation.

**Table 1**

Theoretical PolySorp and MaxiSorp preferences for adsorption of various bio-macromolecules.

PolySorp	MaxiSorp
Lipids	Polyglycans
Compound lipids	Compound polyglycans
Lipoproteins	Glycoproteins
Proteins & Peptides*	

\* Surface preference is dependent on predominance of hydrophobic or hydrophilic amino acid residues in the molecules.



**Fig. 4**

The densest monolayer packing of globular molecules seen from above. The factor  $2/\sqrt{3}$  in the text formulas for surface binding capacities originates in this non-quadratic pattern.

temperature, (more) agitation, to obtain adsorption efficiency comparable with MaxiSorp.

As mentioned above, van der Waals mediated bonds are relatively weak, wherefore they may be insufficient for stable binding when they are few in number, i.e. when the molecules are small. For binding of small molecules strong chemical bonds are needed. Ionic bonds would not do, because they normally dissociate in aqueous solution, leaving covalent bonds as the only possibility for direct, stable binding of small molecules. However, this difficulty may be overcome by using small molecules linked to (indifferent) carrier macromolecules. Small molecules would in this context be e.g. peptides of less than 10 amino acids (corresponding to about 1500 dalton).

#### Geometric Estimation

Before making any experimental estimates of binding capacities on solid phase surfaces, it is worth making an estimate from geometric considerations of how many molecules can maximally be packed in one layer on a surface.

Taking immunoglobulin G antibody (IgG) as an example, and assuming that it is globular and packed in the densest monolayer packing (Fig. 4), the amount  $Q_{\text{GLOBE}}$  per  $\text{cm}^2$  will be:

$$Q_{\text{GLOBE}} = \frac{2}{\sqrt{3}} \cdot \frac{\text{MW}}{N} \cdot \frac{1}{(2r)^2} \cdot 10^9 \text{ ng/cm}^2 = 300 \text{ ng/cm}^2$$

where:

MW = molecular weight of IgG = 153,000 g v mole<sup>-1</sup>

N = Avogadro's number =  $6 \cdot 10^{23}$  mole<sup>-1</sup>

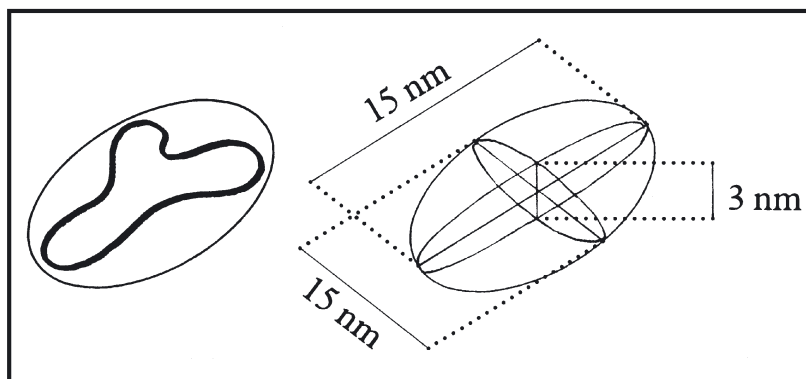
r = Stokes radius of IgG =  $\frac{R \cdot T_{20}}{6 \cdot \pi \cdot \eta_{20} \cdot D_{20} \cdot N}$  cm

R = gas constant =  $8.3 \cdot 10^7$  g · cm<sup>2</sup> · sec<sup>-2</sup> · °K<sup>-1</sup> · mole<sup>-1</sup>

T<sub>20</sub> = room temperature (20°C) = 293°K

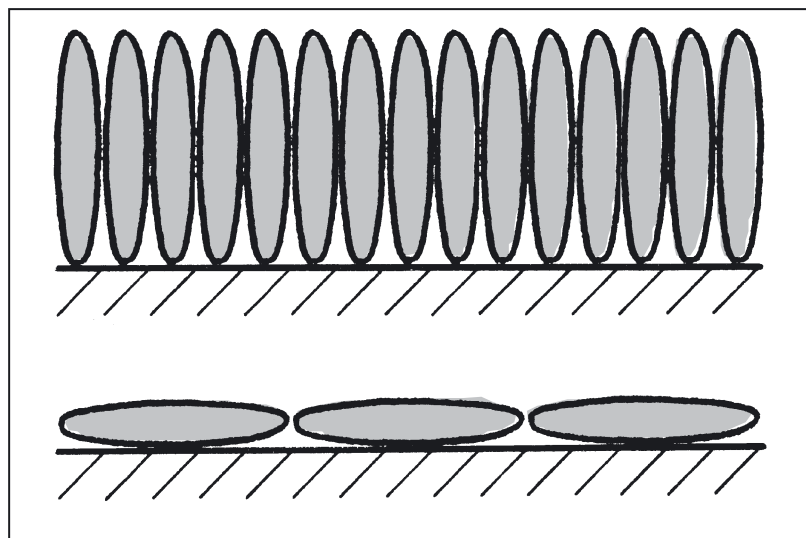
η<sub>20</sub> = viscosity of water at 20°C =  $1 \cdot 10^{-2}$  g · cm<sup>-1</sup> · sec<sup>-1</sup>

D<sub>20</sub> = diff. coeff. of IgG ref. to water at 20°C =  $4 \cdot 10^{-7}$  cm<sup>2</sup> · sec<sup>-1</sup>



**Fig. 5**

The Y-shaped IgG antibody will approximately take up the volume of a lens shaped spheroid with a diameter of 15 nm and a thickness of 3 nm.



**Fig. 6**

Profiles of the densest IgG packings on a surface illustrating the density ratio of 5 to 1 between molecules packed in upright position (above) and in lying position (below).

However, according to various sources, the IgG molecule is rather a lens shaped spheroid with a diameter,  $d$ , of about 15 nm and a thickness,  $t$ , of about 3 nm, as illustrated in Fig. 5.

Assuming the densest packing of these spheroids in »upright« or »lying« position (Fig. 6), the respective  $Q_{\text{LENSE}}$  values will accordingly be:

$$Q_{\text{LENSE}} = \frac{2}{\sqrt{3}} \cdot \frac{\text{MW}}{N} \cdot 10^9 \cdot \begin{cases} 1/t = 650 \text{ ng/cm}^2 & \text{at upright position} \\ 1/d^2 = 130 \text{ ng/cm}^2 & \text{at lying position} \end{cases}$$

So, for geometrical reasons alone, the maximum amount of monolayer IgG that can be bound on a surface is 650 ng/cm<sup>2</sup>. If an average is taken between the two  $Q_{\text{LENSE}}$  figures, the final estimate would be 400 ng/cm<sup>2</sup>.

Assuming that molecular weight is proportional with volume,  $Q$  will not change considerably within wide molecular weight limits, other things being equal, because of the low power relationship between volume and profile area of a body. Fig. 7 illustrates the relationship between  $Q$  and molecular weight for globular molecules.

**Experimental Estimation**

Let us, as an example, stay with IgG, a glycoprotein with a structure shown schematically in Fig. 8.

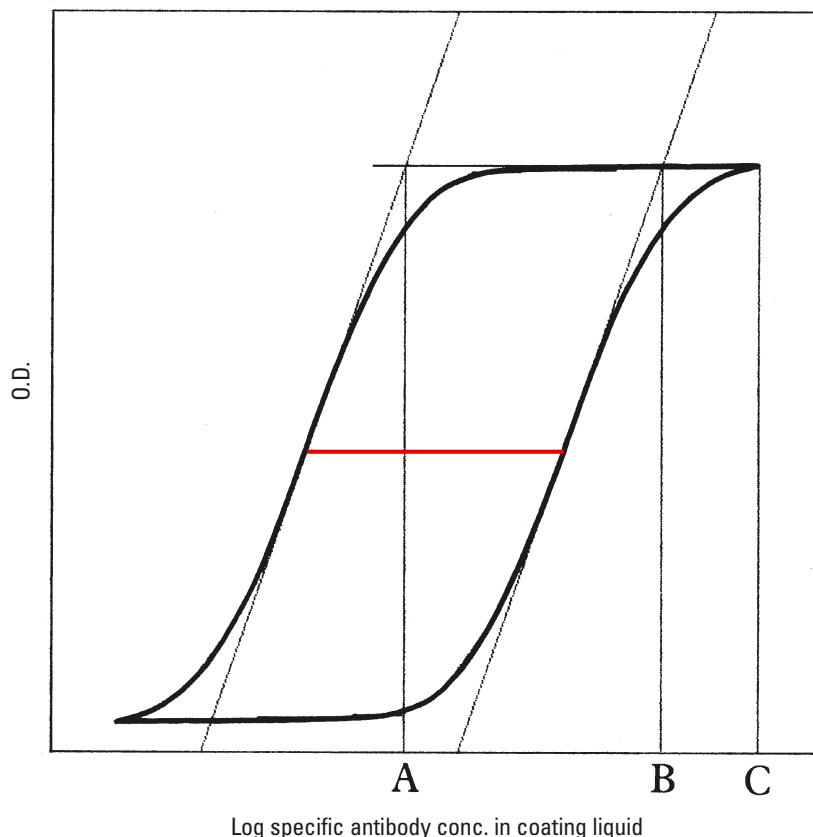
On a MaxiSorp surface, one would expect an orientated adsorption in favor of exposing the antigen recognizing sites, because this surface would favor a binding through the hydrophilic carbohydrate moiety associated with the non-recognizing leg of the molecule.

On a PolySorp surface, on the other hand, one would expect an adsorption in favor of obscuring the antigen recognizing sites, because of the repelling effect between this surface and the carbohydrate moiety.

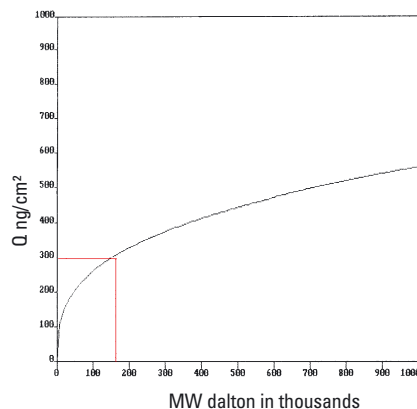
To investigate the actual adsorption conditions, the following experiment was designed (see Fig. 9).

PolySorp and MaxiSorp MicroWell surfaces were coated with a dilution series of specific antibodies, starting with a concentration  $C$  well above saturation concentration, or with a corresponding dilution series mixed with unspecific antibodies to a constant total of  $C$ . The relative amount of specific antibody adsorbed in each case was determined by a sandwich ELISA for the antigen in question using excess antigen and excess HRP conjugated specific antibodies.

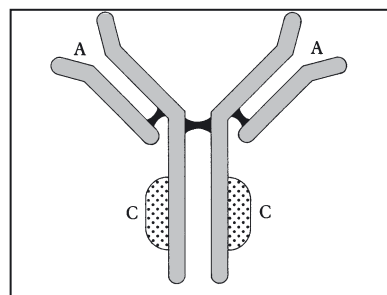
When it is assumed that equal signals mean equal amounts of specific antibody adsorbed in both dilution series, the quantity  $B/C$  is the fraction of the saturation concentration  $S$  formed by the



**Fig. 9** Expected results from ELISA experiments with a dilution series of first layer specific IgG-antibodies, starting with a concentration  $C$  well above surface saturation concentration  $S$  (left sigmoid curve), or with a corresponding dilution series mixed with unspecific IgG to a constant total of  $C$  (right sigmoid curve). The ratio between  $S$  and  $C$  is  $A/B$ , which is represented by the distance between the two curves (red line). See text for further explanation.



**Fig. 7** Relationship between monolayer weight density ( $Q$ ) and molecular weight ( $MW$ ) of globular molecules illustrating that within a 10-factor  $MW$  range  $Q$  will roughly vary within only a 2-factor range. The curve is extrapolated on the basis of an idealized IgG molecule with an  $MW$  of 153,000 (red lines). See text for further explanation.



**Fig. 8** Schematic illustration of the IgG antibody structure. Note the carbohydrate moiety (at  $C$ ) associated with the leg opposite the antigen binding sites (at  $A$ ) of the molecule.

maximum signal concentration A, i.e.  $A = S \cdot B/C$ , or:

$$S = \frac{A}{B} \cdot C$$

In Fig. 10 are shown the results from experiments, designed as above, with four antibodies of different specificities. From the seemingly constant curve distances for MaxiSorp (MS) and PolySorp (PS) respectively, it is concluded that the adsorptions are independent of antibody

specificity, and that they amount to the following quantities:

$$Q_{MS} = \frac{A_{MS}}{B_{MS}} \cdot C \cdot \frac{V}{F} \cdot 10^3 = 650 \text{ ng/cm}^2$$

$$Q_{PS} = \frac{A_{PS}}{B_{PS}} \cdot C \cdot \frac{V}{F} \cdot 10^3 = 220 \text{ ng/cm}^2$$

where:

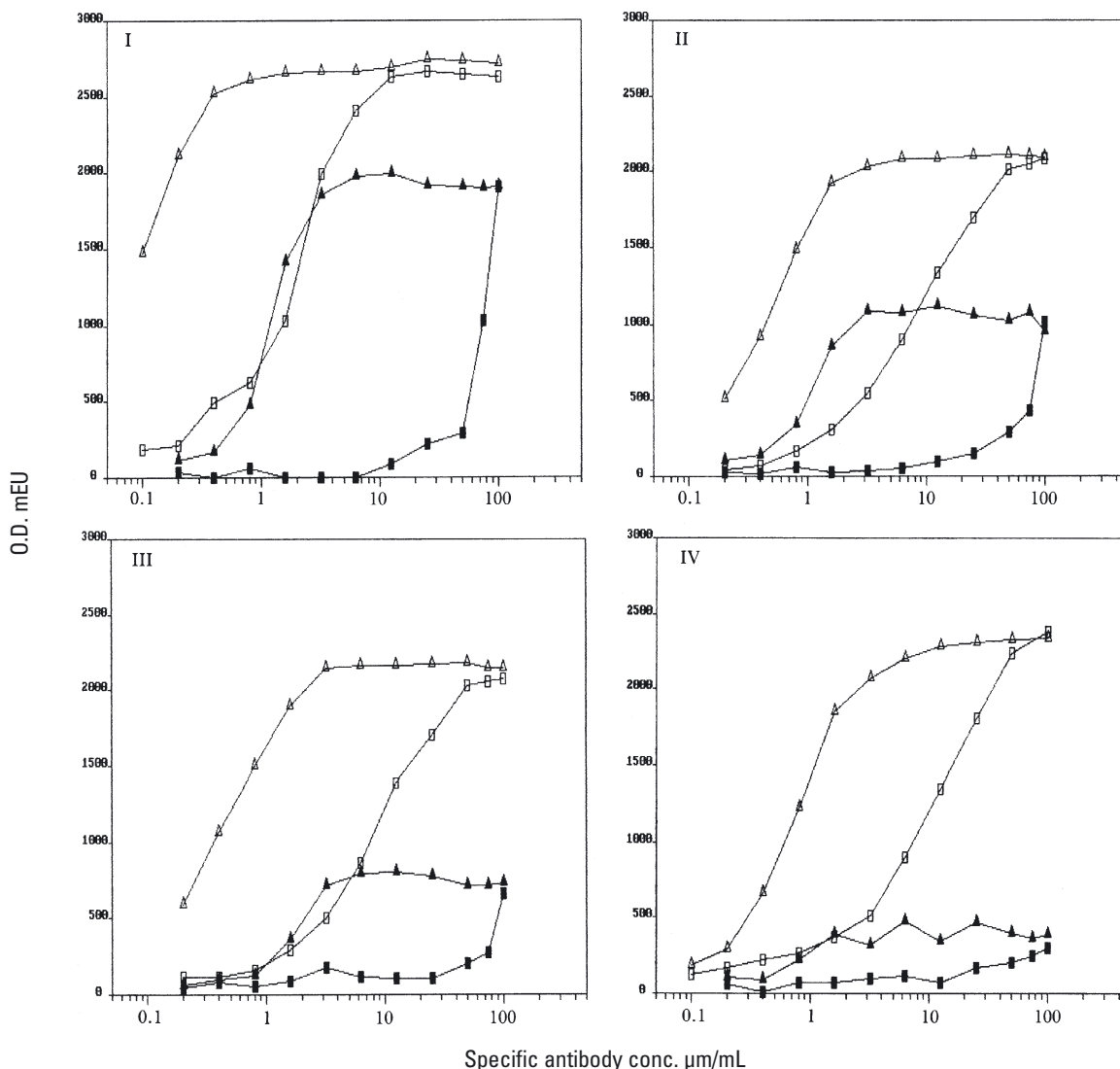
$$A_{MS}/B_{MS} = 1/20$$

$$A_{PS}/B_{PS} = 1/60$$

$$C = \text{max. IgG conc.} = 100 \text{ } \mu\text{g/mL}$$

$$V = \text{reactant volume} = 0.2 \text{ mL}$$

$$F = \text{surface area} = 1.54 \text{ cm}^2$$



**Fig. 10**

Results from experiments prospected in Fig. 9 with four different antibody/antigen systems on MaxiSorp (open symbols) and on PolySorp (filled symbols).

I: ferritin antigen (MW 440,000);

II: fibronectin antigen (MW 450,000);

III: thyroglobulin antigen (MW 670,000);

IV: AFP (a – foetoprotein) antigen (MW 70,000).

Note the seemingly constant curve distances for MaxiSorp and PolySorp respectively, regardless of the system in question.

See text and Fig. 9 for further explanation.

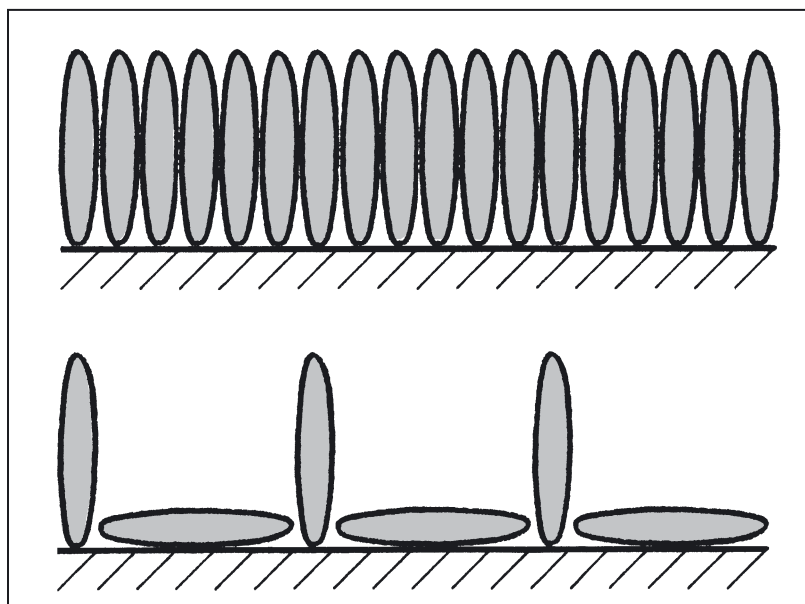
### Discussion

Whereas  $Q_{MS}$  is identical with the geometric maximum estimate for upright molecules,  $Q_{PS}$  is only one third hereof, which can be explained by assuming that on PolySorp upright and lying molecules are present in equal numbers, as illustrated in Fig. 11.

Because each IgG antibody can maximally bind two antigen molecules, this PolySorp decrease in number of adsorbed antibodies would have the greater effect, the smaller the antigen molecules are compared with the antibodies, as illustrated in Fig. 12.

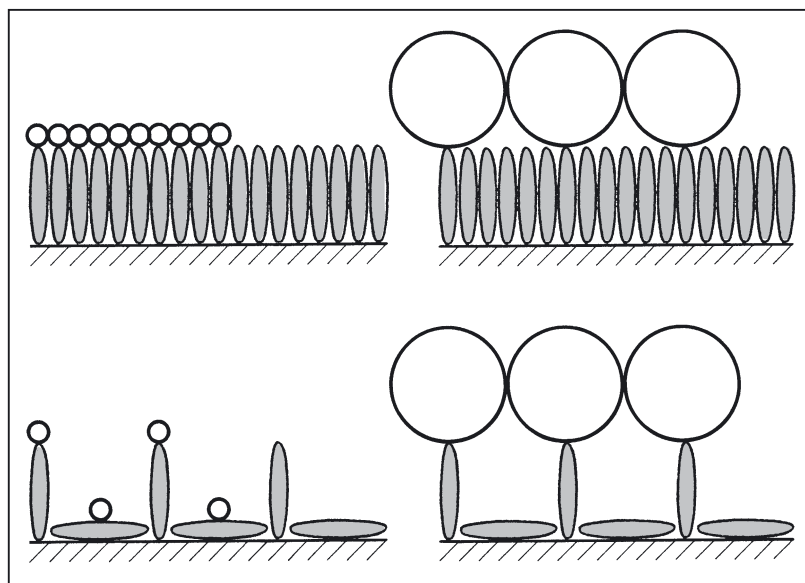
This could, partly at least, explain the very low PolySorp signals for AFP, which has a molecular weight of less than half the weight of IgG, whereas the other antigens have 3-5 times the weight of IgG.

In addition, the variation of PolySorp-to-MaxiSorp maximum signal ratios may be due to differently obstructed affinities through the antibody adsorption to PolySorp, and/or due to different antibody-antigen affinities from one system to the other. In the ferritin system, the affinity seems relatively high since there is a long delay before maximum signal decline on MaxiSorp, which may be consistent with the high PolySorp maximum signal, i.e. the higher the affinity, the less it is obstructed by antibody adsorption to PolySorp.



**Fig. 11**

Profiles of IgG adsorption patterns on MaxiSorp (above) and PolySorp (below) which can explain the experimentally found ratio of 3 to 1 between the densities on the respective surfaces.



**Fig. 12**

Profiles of second layer (antigen) binding to antibody-coated MaxiSorp (above) and PolySorp (below) surfaces illustrating how the presumptive difference between the IgG adsorption patterns may imply a PolySorp decrease in bound amounts of small antigen molecules (left), but not of large antigen molecules (right). It should be noted that the third layer consisting of HRP conjugated antibodies would hardly influence the detection of this phenomenon, as HRP is a relatively small molecule (MW 40,000). See text for further explanation.

# Comparison of Blocking Agents for ELISA

Rachel Pearce Pratt and Bruce Roser, *Quadrant Research Foundation, Cambridge Research Laboratories, Cambridge, England.*

## Introduction

The high sensitivity of ELISA implies a stringent limitation to the acceptable background signal due to non-specifically bound reactants. Low background is usually achieved by thorough “blocking” of the test wells with an inert or irrelevant protein.

This work demonstrates a variation in efficiency of blocking agents dependent on their molecular weight.

## Methods and Results

Flat bottomed 96 well polystyrene plates (Thermo Scientific Nunc Immuno Plate MaxiSorp F96) were used in all experiments.

We compared the three blocking agents: bovine serum albumin (BSA), newborn calf serum (NBCS), and casein (i.e. sodium caseinate: 25 g casein powder (Sigma) dissolved in 800 mL 0.3 M NaOH by overnight stirring at 37°C, then titrated to pH 7.0 with HCl and made up to 1000 mL). After incubation of the wells with a dilution series in PBS of the respective blocking agents overnight at 4°C, and subsequent incubation with 1:4 PBS diluted rat serum for 90 min. at 4°C, each followed by washing with PBS + 0.05% Tween 20, the leakiness of the blocking layer for rat Ig was detected using the signal producing reagents: anti-rat rabbit F(ab')<sub>2</sub> conjugated with horse radish peroxidase (HRP), and H<sub>2</sub>O<sub>2</sub>/tetramethyl-benzidine (TMB) enzyme substrate.

The results, which are shown in Fig. 1, confirm the superiority of casein for blocking agent.

In order to investigate the nature of the blocking leakiness, the two enzymes HRP and alkaline phosphatase (AP) were used. The wells were coated with one enzyme, blocked with NBCS or casein, and incubated with a dilution series of the other enzyme followed by addition to separate wells of the respective substrates: H<sub>2</sub>O<sub>2</sub>/TMB and para-nitrophenyl phosphate (PNPP).

Substrate for 1st stage enzyme was added to detect any displacement of that enzyme, whereas substrate for 2nd stage enzyme was added to detect penetration of the blocking layers by that other enzyme.

The results, which are shown in Fig. 2, indicate that blocking leakiness is rather due to penetration than to displacement of the blocking layers.

Again, attention was drawn to casein, specifically, why was it a better blocking agent?

HPLC gel filtration of casein and NBCS in PBS on a TSK HW 55S column (LKB, Sweden) showed that NBCS consists of protein species > 60 kD while casein contains a heterogeneous collection of molecular species from > 60 kD to < 10 kD (Fig. 3).

Fractionation of casein by ultrafiltration into three molecular weight (MW) grades, MW < 10 kD, MW > 30 kD, and 10 kD < MW < 30 kD, enabled us to show that the high blocking efficiency of casein was entirely due to its

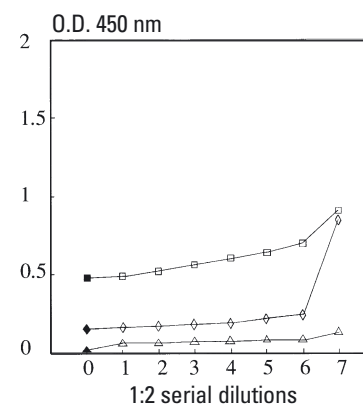
content of small MW proteins, and that the blocking potency was “inversely proportional” to the MW of the component proteins (Fig. 4).

## Summary

Blocking leakiness seems to be due to penetration and not to displacement of blocking layers by 2nd stage reagents.

Casein appears to be an effective blocking agent due to its content of small protein species.

BSA and NBCS contain relatively large MW components so that random close packing of these molecules leaves bare patches of unblocked plastic surface to which 2nd stage reagents can bind, leading to higher background characteristics of these blocking agents.



**Fig. 1**

Efficiency of three blocking agents. Neither 100 mg/mL BSA (■) nor neat NBCS (◆) block the immobilization of rat Ig from 1:4 diluted serum as effectively as 25 mg/mL casein (▲). On dilution (open symbols) the failure of blocking is also more striking with the former agents than with casein.



**Further Reading**

Batteiger B., Newhall V.W.J. & Jones R.B. (1987).

The use of Tween 20 as blocking agent in the immunological detection of proteins transferred to nitrocellulose membranes. *J. Immunol. Methods* 55, 297-307.

Bird C.R., Gearing A.J.H. & Thorpe R. (1988).

The use of Tween 20 alone as a blocking agent in Immunoblotting can cause artefactual results. *J. Immunol. Methods* 106, 175-179.

*J. Immunol. Methods* 106, 175-179.

Engvall E. (1981).

*Methods in Enzymology* 70, 419.

Eds. Langone & Numakis.

Acad. Press, London.

Fleming J.O. & Pen L.B. (1988).

Measurement of the concentration of murine IgG monoclonal antibody in hybridoma supernatant and ascites in absolute units by sensitive and reliable enzyme-linked immunosorbent assays (ELISA). *J. Immunol. Methods* 110, 11-18.

*J. Immunol. Methods* 110, 11-18.

Gardas A. & Lewartowska A. (1988).

Coating of proteins to polystyrene ELISA plates in the presence of detergents. *J. Immunol. Methods* 106, 251-255.

*J. Immunol. Methods* 106, 251-255.

Hoffman W.L. & Jump A.A. (1986).

Tween 20 removes antibodies and other proteins from nitrocellulose. *J. Immunol. Methods* 94, 191.

*J. Immunol. Methods* 94, 191.

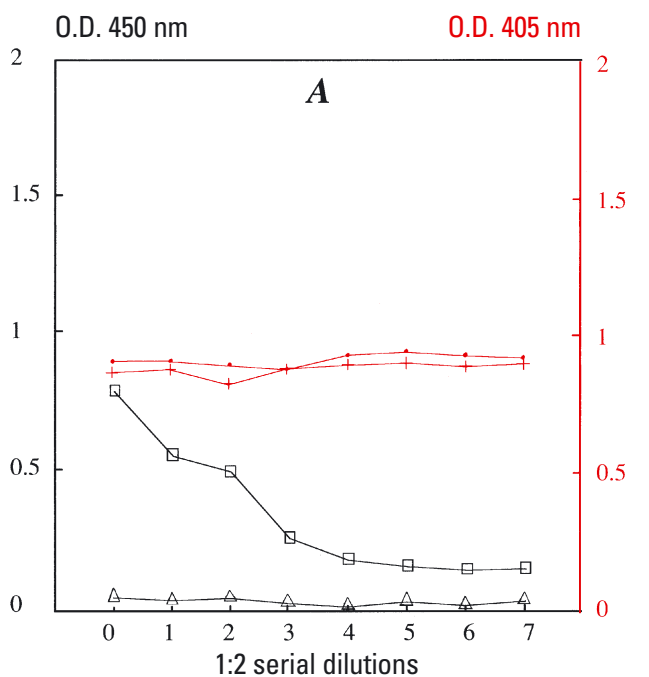
Pearce Pratt R. & Roser B. (1989).

False positive signals in enzyme immunoassay (EIA): (II) Non antigen specific binding between Ig subclasses. Submitted.

Submitted.

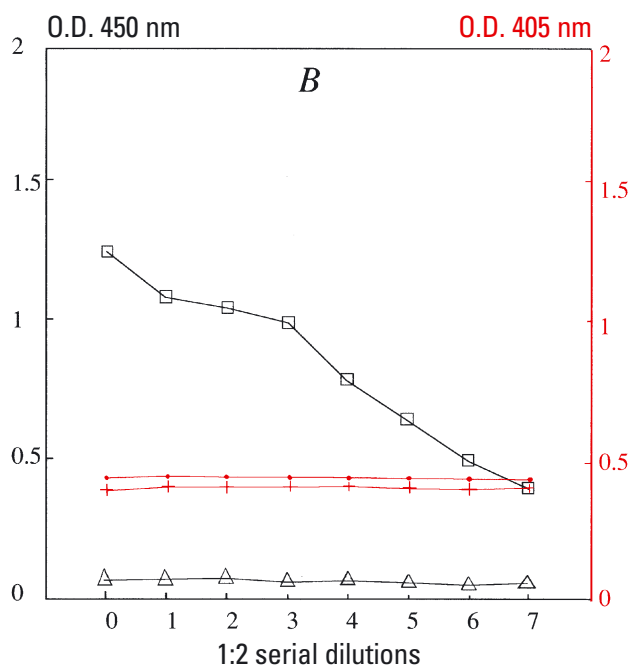
**Acknowledgements**

This work was partly funded by MRC Programme grant No. PG8215534.

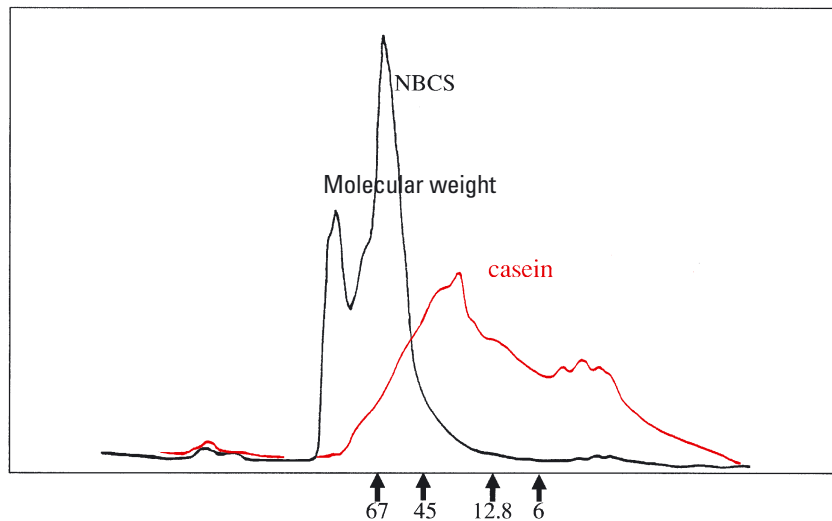


**Fig. 2**

Penetration of "blocking" AP by HRP (A), and vice versa (B). A saturating layer of 1st stage enzyme (■), supplemented with a secondary blocking with 10% v/v NBCS, was penetrated by 2nd stage enzyme in a dose-dependent manner (□). When the secondary blocking was with 25 mg/mL casein, no penetration occurred at any dose of 2nd stage enzyme (△). There was no significant displacement of 1st stage enzyme by the secondary reagents (+). Converted HRP and AP substrates were measured at 450 and 405 nm, respectively.



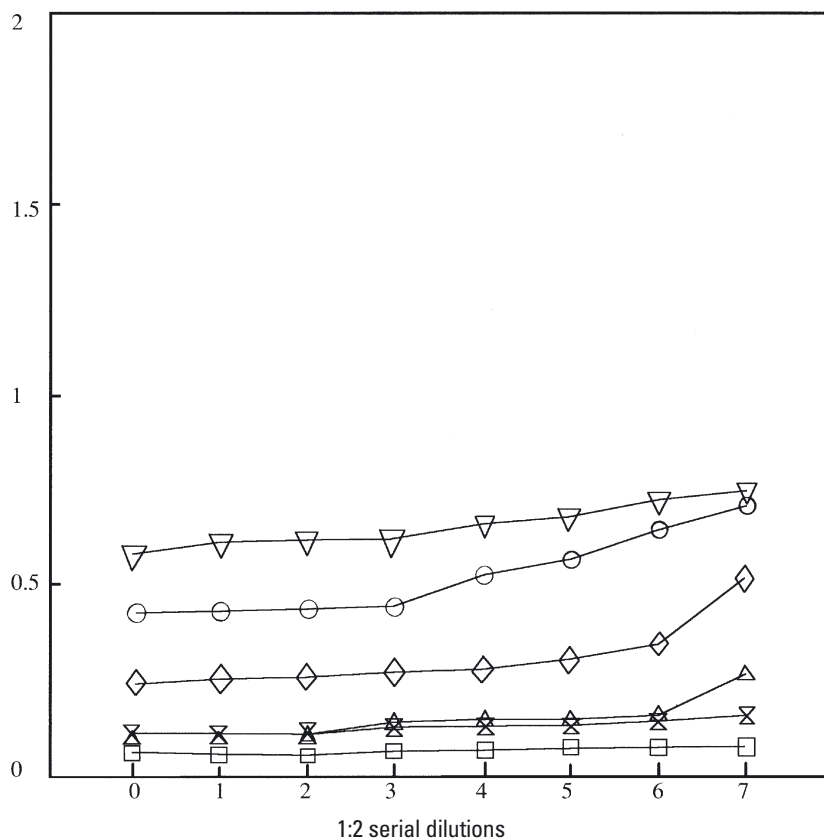
O.D. 280 nm



**Fig. 3**

Gel filtration analysis of NBCS and sodium caseinate showing that whereas there are very few molecules smaller than 45 kD in NBCS, the size of the casein components is very heterogeneous with many molecules smaller than 6 kD. The MW standards refer to BSA (67 kD), ovalbumin (45 kD),  $\alpha$ -lactalbumin (12.8 kD), and insulin (6 kD).

O.D. 450 nm



**Fig. 4**

Molecular size and blocking efficiency. Blocking of rat Ig immobilization with casein components from size fractionation confirms that smaller molecules block better. Rat Ig penetrated blocking layers of BSA ( $\nabla$ ) and NBCS ( $\circ$ ) giving high plateau background levels and early failure of blocking with dilution. Casein molecules  $> 30$  kD ( $\diamond$ ) were much less effective than molecules  $< 10$  kD ( $\square$ ). Casein molecules between 10 and 30 kD were intermediate in effectiveness ( $\triangle$ ), comparable with unfractionated casein (X). The initial concentration of each blocking agent corresponds to  $E_{280} = 4.0$ .

[www.thermoscientific.com/oemdiagnostics](http://www.thermoscientific.com/oemdiagnostics)

© 2010 Thermo Fisher Scientific Inc. All rights reserved. "Tween" is a registered trademark of Uniqema Americas. All other trademarks are the property of Thermo Fisher Scientific Inc. and its subsidiaries.

# Detergent in Polystyrene ELISA

Peter Esser, M.Sc., Senior Scientist, Thermo Fisher Scientific

Detergent is used in ELISA for washing off loosely or unspecifically bound reactants. It may also be used for blocking possible excess solid surface (e.g. polystyrene) after coating with one reactant to avoid unspecific immobilization of subsequent reactants.

Often a detergent is used according to tradition and routine procedures, or it is arbitrarily adopted from one application to another.

However, detergent may be a double-edged sword and should be selected with care depending on the particular assay reactants and immobilizing surface material.

## Introduction

Detergents are molecules consisting of a distinct hydrophobic and hydrophilic part (Table 1).

Their washing effect is based on the ability to disperse hydrophobic molecules in aqueous medium, i.e. to dissolve unstable hydrophobic bonds between surface and coating reactant, and unspecific hydrophobic bonds mutually between reactants on the surface.

Their blocking effect is based on the ability to compete with other molecules for both hydrophobic and hydrophilic binding sites.

However, an immobilized detergent may in itself affect further specific and unspecific immobilization characteristics of the solid phase, e.g. by applying hydrophilic groups to a hydrophobic surface, or by interfering with the active sites of reactant molecules.

The reversibility of possible detergent mediated solid phase alterations depends on the detergent binding strength,

implying detergent size, charge and structure in relation to the other assay ingredients. Therefore, the use of detergent should be optimized for each separate application.

## Method and Results

To elucidate some of the detergent conditions mentioned above, five detergents of various sizes and charges (schematized in Table 1) were tested in a catching antibody assay according to the procedure listed in Table 2. Thermo Scientific Nunc Immuno Modules F8 with physically adsorbing surfaces, i.e. partly hydrophilic MaxiSorp (Cat. No. 468667) and hydrophobic PolySorp (Cat. No. 469078) were used. The results are presented in Fig. 1.

## Discussion

From the results with the present test system several detergent effects relevant to ELISA can be observed (Fig. 1):

1. In general, the detergents exert a blocking effect against unspecific adsorption only if they are present together with the conjugates (++- and +++); only in these cases there are no significant unspecific signals.
2. Tween 20 makes an exception to statement 1. Its presence in the 1st wash seems to be sufficient for blocking unspecific adsorption in subsequent layers on both surfaces. This may be a consequence of its relatively large size, which presumably implies that it remains firmly bound to the surface, unlike the other detergents. However, its larger size is due merely to a larger hydrophilic part, wherefore it is difficult to explain its stable blocking effect on the hydrophobic Nunc™ PolySorp™ surface.
3. The positively charged DTAB exhibits large unspecific signals in all cases. Probably it binds to the conjugates, thereby facilitating their unspecific adsorption.
4. Tween 20 and DTAB seem to enhance the signals when used in the 2nd wash (+--+ and +++). This may be due to the presence of detergent remnants in the substrate solutions in those cases. In a control experiment with or without detergent added to the substrate solution after direct coating of the surfaces with HRP conjugate it was indeed observed, especially with MaxiSorp™, that Tween 20 and DTAB enhanced the substrate reaction; SDS and CHAPS somewhat reduced the reaction, whereas Triton X-100 was indifferent. There is no immediate explanation to these interferences with the substrate reaction.
5. Tween 20, Triton X-100, and in particular SDS give small specific PolySorp signals (compared with CHAPS), whereas only SDS gives relatively small signals with MaxiSorp. This may be explained by differences in washing effects between the detergents, SDS being the most harsh, combined with the fact that PolySorp binds less native antibody in a stable way than

**Table 1**

Schematic illustration of the five detergents used in the experiments. Tween 20 = ikosaoxyethylene sorbitan monolaurate (Merck 822184); Triton X-100 = octylphenoxy octaethoxy ethanol (Merck 8603); SDS = sodium dodecyl sulfate (Serva 20760); DTAB = dodecyltrimethylammonium bromide (Sigma D-8638); CHAPS = 3-[(cholamidopropyl) dimethylammonio]-1-propanesulfonate (Sigma C-3023). According to other sources, the hydrophilic polyoxyethylene part of Tweens is divided into three separate arms linked to the sorbitan part, and the hydrophobic octyl part of Triton X-100 is branched.

	Hydrophobic part	Hydrophilic part
Non ionic	<b>Tween 20 (MW 1240)</b>	$\begin{array}{c} \text{CH}_2-\text{CH}-\text{O}-(\text{CH}_2\text{CH}_2\text{O})_{20}-\text{H} \\   \\ \text{O} \\   \\ \text{CH}-\text{CHOH} \\   \\ \text{CHOH} \\   \\ \text{CO}-\text{O}-\text{CH}_2 \\   \\ \text{H}_3\text{C}-\text{C}_{11}\text{H}_{23} \end{array}$
	<b>Triton X-100 (MW 646)</b>	$\begin{array}{c} \text{H}_3\text{C}-\text{C}_7\text{H}_{15}-\text{C}_6\text{H}_4-(\text{OCH}_2\text{CH}_2)_{10}-\text{OH} \end{array}$
Ionic + or -	<b>SDS (MW 265+23)</b>	$\begin{array}{c} \text{H}_3\text{C}-\text{C}_{11}\text{H}_{23}-\text{O}-\text{S}(=\text{O})_2-\text{O}^- \quad \text{Na}^+ \end{array}$
	<b>DTAB (MW 228+80)</b>	$\begin{array}{c} \text{H}_3\text{C}-\text{C}_{11}\text{H}_{23}-\text{N}^+(\text{CH}_3)_3 \quad \text{Br}^- \end{array}$
Z w i t t e r i o n i c	<b>CHAPS (MW 614)</b>	$\begin{array}{c} \text{CH}_3 \\   \\ \text{HO}-\text{C}_{27}\text{H}_{45}-\text{C}(\text{OH})(\text{CH}_3)-\text{CH}_2-\text{C}(=\text{O})-\text{N}(\text{H})-\text{CH}_2-\text{CH}_2-\text{N}^+(\text{CH}_3)_2-\text{CH}_2-\text{CH}_2-\text{SO}_3^- \end{array}$

Step	Reagent	Time	% Detergent added				
			(0)	(0)	(0)	(0)	(0)
1st layer	SaR, 5 µg/mL in PBS or None	overnight	(0)	(0)	(0)	(0)	(0)
1st wash	PBS + 0.2 M extra NaCl	3x	0	.05	.05	.05	.05
2nd layer	R:HRP, 1.3 µg/ mL in PBS or S:HRP, 1.3 µg/ mL in PBS	2 hr	0	0	.05	0	.05
2nd wash	PBS + 0.2 M extra NaCl	3x	0	0	0	.05	.05
Detergent code used in Figs. 1-3			---	+-	++	+-	+++

**Table 2**

Procedure with MicroWell plates with MaxiSorp or PolySorp surfaces using each of the five detergents in the five code alternatives (bottom row), all in one experiment. The procedure was followed by HRP reaction using H<sub>2</sub>O<sub>2</sub>/OPD substrate. SaR = swine anti-rabbit antibody (Dako Z 196) = catching antibody; R:HRP = peroxidase conjugated rabbit antibody (Dako P 128) = target conjugate; S:HRP = peroxidase conjugated swine antibody (Dako P 217) = indifferent conjugate.

does MaxiSorp<sup>1</sup>. However, a consequence of this would be: the lower the specific signal, the higher the signal if the surface has only been cleared for loosely bound antibody by 1st wash detergent (+--).

This does not seem to be the case in general, so an additional inhibitory interference with the antibody specificities, especially by SDS, may be postulated in accordance with findings by others<sup>2</sup>.

6. Without detergent (---) there seems to be no difference between the signals with specific and unspecific conjugate, nor between MaxiSorp and PolySorp.

In a control experiment using <sup>125</sup>I labelled 1st layer antibody it was found that equal amounts of antibody remained on MaxiSorp and PolySorp when no detergent was subsequently used. This can explain the equality of specific signals on MaxiSorp and PolySorp by absence of detergent, but not the equally large unspecific signals. The latter may be explained by occurrence of a second-positioned, unspecific

adsorption of conjugate in competition with specific binding.

A schematic explanation of the general detergent conditions is attempted in Fig. 2, which has given rise to the stoichiometric modelling in Fig. 3.

#### MaxiSorp after coating

Some loose binding sites have remained unoccupied, whereby an equal amount of specific sites have remained available.

After --- : By absence of detergent no loosely bound antibody has been washed off, thus some specific sites have remained masked. Available specific and unspecific binding sites have competed for target conjugate binding.

After +++ (or +-): By presence of detergent in every step all unspecifically bound antibody/conjugate has been washed/kept off, having left all specific sites available for target conjugate binding.

After +- : By presence of detergent in the 1st wash only, the loosely bound antibody has been washed off, having unmasked all specific sites, which have been

competing for target conjugate with some unspecific sites capable of conjugate binding.

After +-+ : Same as after +- -, because all unspecifically bound conjugate has been firmly bound, possibly through the enzyme (I).

#### PolySorp after coating

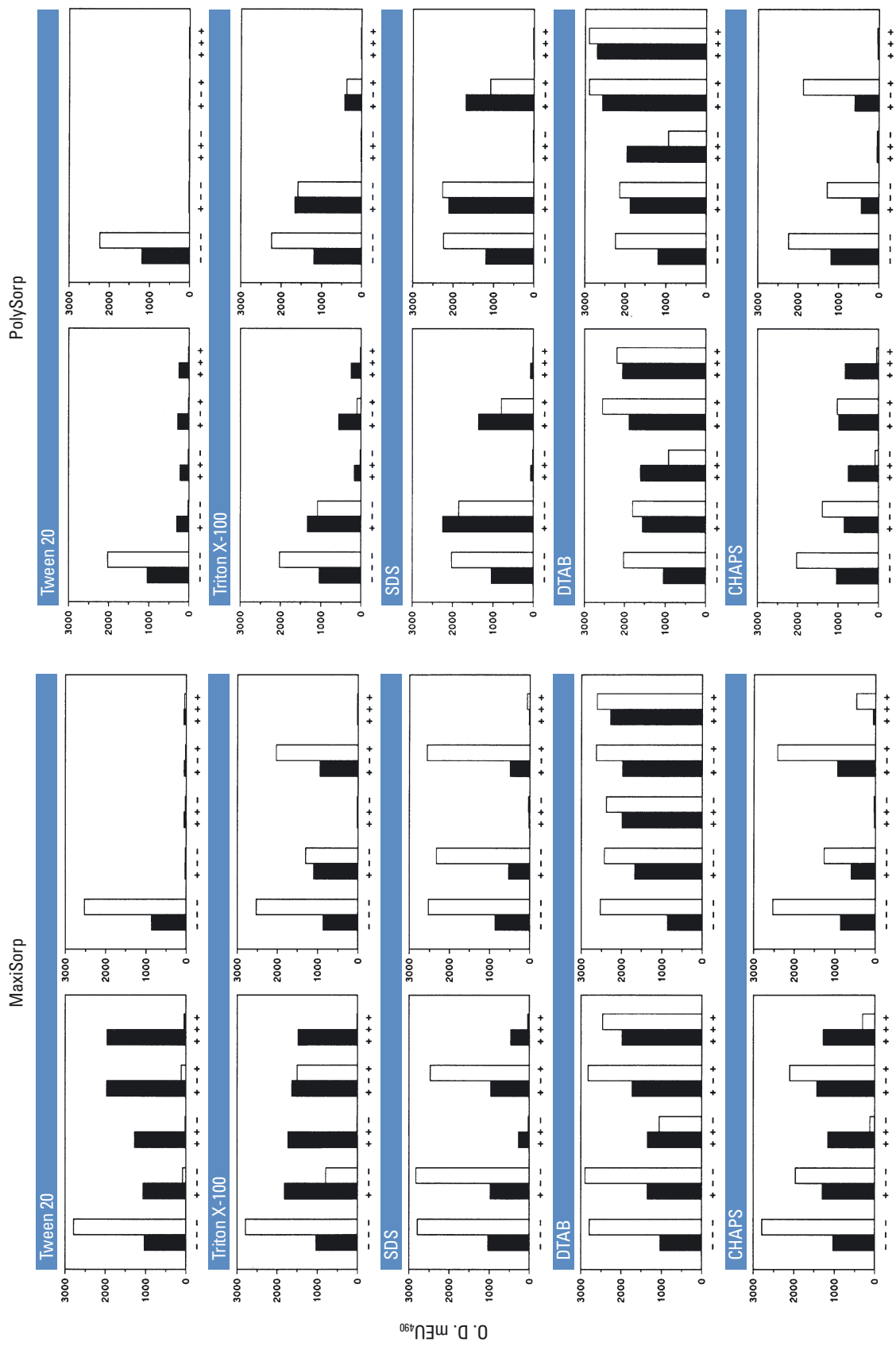
Same as MaxiSorp, except that more antibody has been loosely bound at the expense of firmly bound antibody.

After --- : Same as MaxiSorp, except that unspecifically bound conjugate has only been loosely bound, possibly through the enzyme (+).

After +++ (or +-): Same as MaxiSorp, except that more loosely bound antibody/conjugate has been washed/kept off, having left less antibody on the surface for target conjugate binding.

After +- : Same as MaxiSorp, except that more space has been available for unspecific binding of conjugate, some of which has been firmly bound, possibly through the enzyme (I).

After +-+ : Same as after +- -, except that loosely bound conjugate has been washed off by presence of detergent in the 2nd wash.



**Fig. 1** Mean results with MaxiSorp (left diagram block) and PolySorp (right diagram block) from three independent experiments, each one with mutually comparable signals obtained according to the procedure in Table 1. Left diagrams (in MaxiSorp and PolySorp block respectively) show results for target conjugate; right diagrams show results for indifferent conjugate; ■ = with 1st layer; □ = without 1st layer.

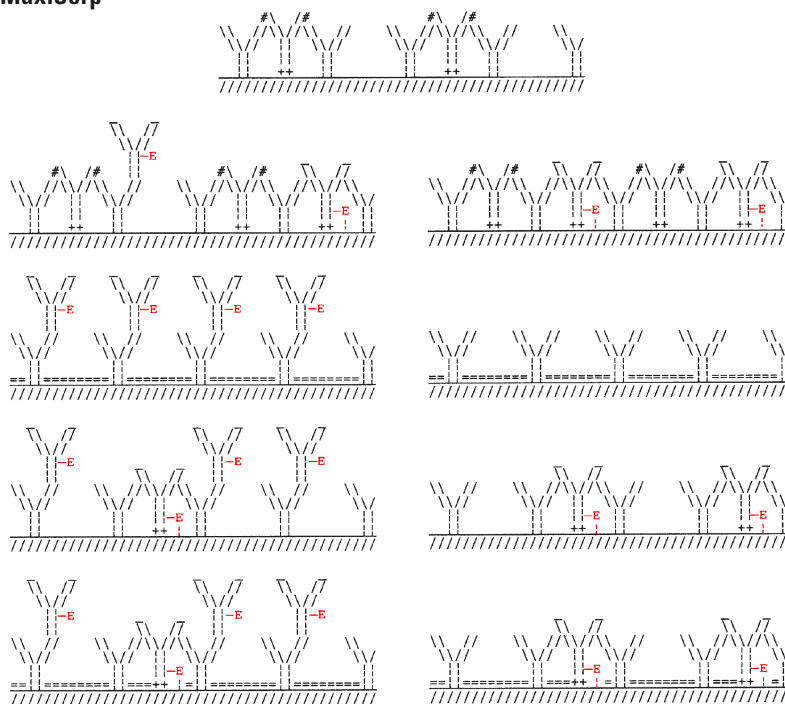
## Conclusion

From this investigation some general guidelines concerning the use of detergent in ELISA can be extracted:

1. Detergent is necessary for washing off loosely adsorbed reactant to abolish sterical hindrances caused by reactant crowding on the surface.
2. If no other blocking agent is used, detergent must be present during incubation with post-coating reactants to avoid unspecific adsorption. Tween 20 is an exception, as it performs a stable blocking once applied, like typical blocking agents such as BSA or casein.
3. Detergents with net charges like SDS and DTAB must be avoided because of their disadvantageous interferences with the assay reactants.
4. Among the investigated detergents, Triton X-100 or Tween 20 seem to be optimal for application with the MaxiSorp surface, whereas the apparently more gentle CHAPS may be the best choice with PolySorp.

This investigation does not give a complete picture of the detergent conditions with ELISA. Important aspects, such as detergent effect dependence on concentration and pH, or detergent performance in concert with typical blocking agents, must wait to be addressed at a later time.

### MaxiSorp



### PolySorp

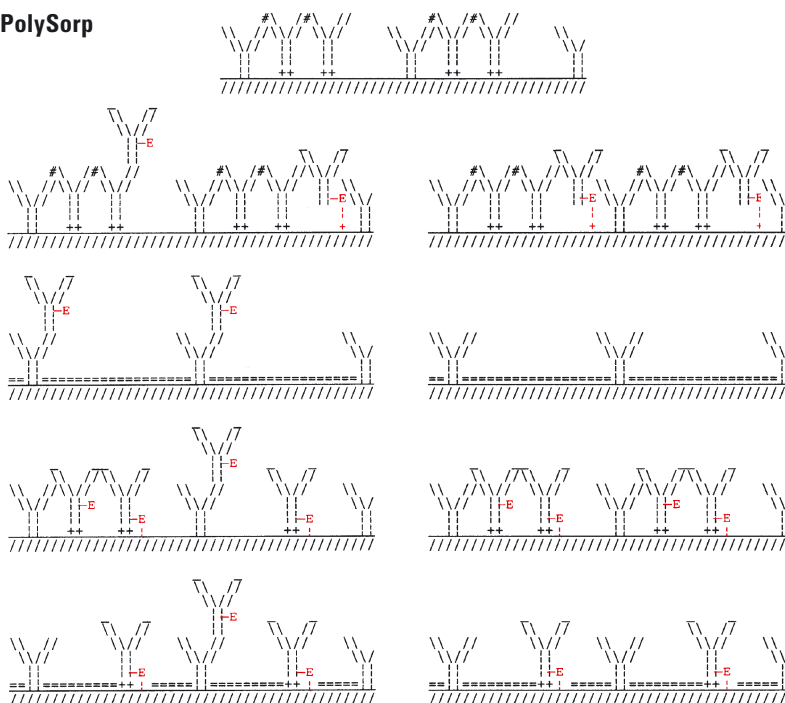
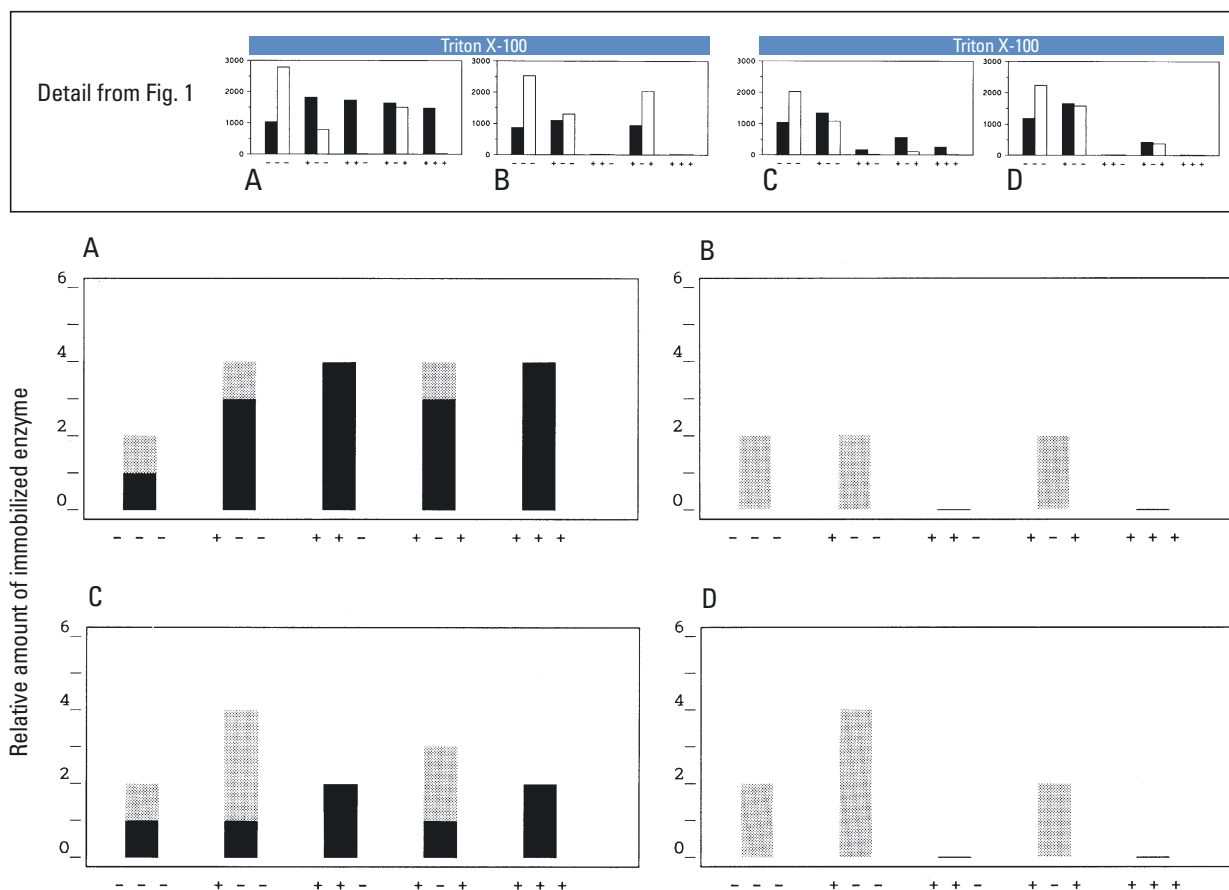


Fig. 2

Schematic explanation of the results in Fig. 1 for MaxiSorp (above) and PolySorp (below) with special reference to the Triton X-100 results. Left and right diagrams illustrate the situations with target and indifferent conjugates, respectively; Y-shapes represent antibodies; Y-E represents enzyme conjugated antibody whose non-involved specific sites are indicated by the small »closing« lines above the arms. The overall idea is that unless detergent is subsequently used (= =) some coating antibody will be loosely bound (++) in a secondary position between the firmly bound antibody and resulting in mutual sterical hindrance (#) of antibody specificities. Consequently, for spatial reasons, the implied secondary, unspecific binding sites are assumed to compete with the specific sites for target conjugate binding by absence of detergent. For simplicity, only the right arm antibody specificities are considered.



**Fig. 3** Stoichiometric model, based on counts of immobilized enzyme in Fig. 2, of the results for coated surfaces, i.e. with 1st layer, resembling most closely the results with Triton X-100 (filled columns in above detail) A & B: MaxiSorp; C & D: PolySorp; A & C: with target conjugate; B & D: with indifferent conjugate; ■ = specific part of signals; ▨ = unspecific part of signals.

## References

- Esser P. (1988).  
Principles in adsorption to polystyrene.  
Thermo Scientific Nunc Bulletin No. 6, 1-5.
- Crumpton M.J. & Parkhouse R.M.E. (1972).  
Comparison of the effects of various  
detergents on antigen-antibody  
interaction.  
FEBS Letters 22, 210-212.

[www.thermoscientific.com/oemdiagnostics](http://www.thermoscientific.com/oemdiagnostics)

© 2010 Thermo Fisher Scientific Inc. All rights reserved. "Tween" is a registered trademark of Uniqema Americas; "CHAPS" and "DTAB" are a registered trademark of Sigma-Aldrich Company; "SDS" is a registered trademark of Serva Chemical Company; and "Triton" is a registered trademark of Dow Chemical Company. All other trademarks are the property of Thermo Fisher Scientific Inc. and its subsidiaries.



# Blocking Agent and Detergent in ELISA

Peter Esser, M.Sc., Senior Scientist, Thermo Fisher Scientific

If a blocking agent is used together with detergent in ELISA, one must take into account that these reagents are competitors as far as blocking effect is concerned. Therefore they may counteract each other if not used with care.

In continuation of the investigation presented in Thermo Scientific Nunc Bulletin No. 8<sup>1</sup>, each of the three neutral detergents, Tween 20, Triton X-100, and CHAPS, was examined with each of the two blocking agents, BSA and casein, using a two-layer antibody sequence in Thermo Scientific Nunc Immuno MicroWell plates with MaxiSorp and PolySorp surfaces.

## Introduction

Agents may be used in ELISA for blocking possible excess solid surface after coating with one immuno-reactant to avoid unspecific immobilization of succeeding reactants. One reason for using a true blocking agent would be to substitute detergent

for blocking; if detergent is present during incubation with secondary reactants, it might in some way interfere with the immunologic specificities or cause unspecific immobilization of the reactants<sup>1</sup>; if detergent is present during wash after secondary reactants, possible weak immunologic affinities might be broken by the washing activity of the detergent. Another reason for using a blocking agent would be to stabilize the immobilized reactant by sterical support<sup>2</sup>. This is relevant for storage of coated surfaces, especially for competitive assays needing unsaturated coatings.

A typical blocking agent would be a neutral macromolecule, large enough to establish a stable attachment to the surface, yet small enough to find its way between immuno-reactants, e.g. antibodies. Bovine serum albumin (BSA) of MW 67,000 is commonly used as a blocking agent. Also the more heterogeneous casein is often used and may be more effective than BSA<sup>3,4</sup>.

The problem of using both detergent and blocking agent occurs during the wash after 1st layer immobilization on the surface. If detergent is used in this wash, one may risk (depending on the detergent) unstable attachment of the succeeding blocking agent. On the other hand, if detergent is avoided in this wash, one may risk that the blocking agent will be hindered from reaching the surface by loosely attached 1st layer reactant<sup>1</sup>. This implies that by later wash with detergent, spaces may be exposed for unspecific immobilization of subsequent reactants (see Fig. 1).

Therefore, blocking agent and detergent should primarily be regarded and administered as alternatives. It is the objective of this work to investigate, if and how the use of blocking agent and detergent in concert can be simplified to ensure minimal counteraction and still maintain the respective desired effects.

Step	Reagent	Time	0.05% Detergent added							
			(-)	(-)	(-)	(-)	(-)	(-)	(-)	(-)
1st layer	SaR, 5 µg/mL in PBS or None	Overnight	(-)	(-)	(-)	(-)	(-)	(-)	(-)	(-)
1st wash	PBS + 0.2 M extra NaCl	3x	-	-	-	-	+	+	+	+
Blocking	BSA, 0.5% in PBS or Casein, 0.5% in PBS	0.25 hr	(-)	(-)	(-)	(-)	(-)	(-)	(-)	(-)
2nd wash	PBS + 0.2 M extra NaCl	3x	-	+	+	-	-	+	+	-
2nd layer	R:HRP, 1.3 µg/mL in PBS or S:HRP, 1.3 µg/mL in PBS	2 hr	-	-	+	+	-	-	+	+
3rd wash	PBS + 0.2 M extra NaCl	3x	-/+	-/+	-/+	-/+	-/+	-/+	-/+	-/+
Three first position detergent code used in Fig. 2			---	-+-	-++	--+	+-	++	+++	+-+

**Table 1**

Procedure with MaxiSorp or PolySorp MicroWell surfaces. Each of the two blocking agents was tested together with each of the three detergents used in sixteen alternative combinations [last eight columns], all in one experiment. The procedure was followed by HRP reaction using H<sub>2</sub>O<sub>2</sub>/OPD substrate. SaR = swine anti-rabbit antibody (Dako Z 196) = catching antibody; R:HRP = peroxidase conjugated rabbit antibody (Dako P 128) = target conjugate; S:HRP = peroxidase conjugated swine antibody (Dako P 217) = indifferent conjugate.

## Materials and Method

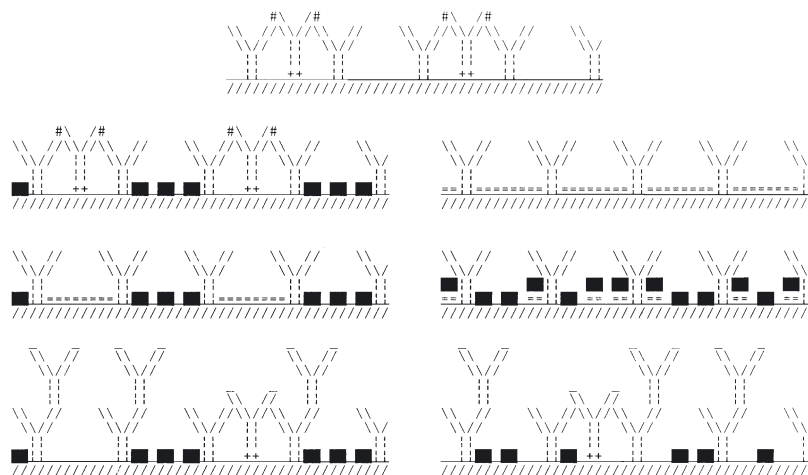
Each of the three neutral detergents, Tween 20 (Merck 822184), Triton X-100 (Merck 8603), and CHAPS (Sigma C-3023), was tested together with each of the two blocking agents, BSA (Sigma A-4503) and casein (Sigma C-5890) in a catching antibody assay according to the procedure listed in Table 1. Thermo Scientific Nunc Immuno Modules MaxiSorp F8 (Cat. No. 468667) and PolySorp F8 (Cat. No. 469078) were used.

## Results and Discussion

Preliminary experiments clearly demonstrated that addition of detergent in the blocking step destroys the effect of the blocking agent. Therefore this situation was left out of the experimental schedule.

From the results with Triton X-100 and BSA (Fig. 2 below), one makes the following observations:

1. If the detergent is used only in the 2nd wash ( $- + -$ ), or only in the 1st and the 2nd washes ( $+ + -$ ), significant unspecific signals occur. In the first situation ( $- + -$ ), probably the blocking agent has been hindered from reaching areas of the surface occupied by loosely attached 1st layer reactant. This has then been washed off by detergent in the 2nd wash, having opened spaces for unspecific attachment of later reactants (see Fig. 1 left). In the other situation ( $+ + -$ ), probably some of the blocking agent has been only loosely attached to the surface due to the preceding wash with detergent. This has resulted in removal of some blocking agent by detergent in the 2nd wash and thus opened spaces for unspecific attachment of later reactants (see Fig. 1 right).
2. The disadvantages stated above can be remedied by including detergent during conjugate incubation. Actually, all situations with detergent and conjugate present simultaneously (i.e. codes with “+” in the third position) exhibit specific signals. The unspecific signals can also be eliminated by detergent in the 3rd wash with PolySorp, but not with MaxiSorp. This can be explained by assuming that unspecific conjugate attachment is more loose (i.e. detergent sensitive) on PolySorp than on MaxiSorp.
3. Presence of detergent in the 1st wash only ( $+ - -$ ), or supplemented with detergent in the 3rd wash ( $+ - +$ ), implies specific signals. Probably the loosely attached blocking agent (cf. point 1) has been allowed to stay and exert its blocking effect on the surface due to the absence of detergent in the succeeding influential steps.
4. Complete absence of detergent ( $- - -$ ) also implies a specific signal, but on MaxiSorp it tends to be reduced. This is presumably due to sterical hindrance of 1st layer specificities by loosely attached antibody, which has not been washed off due to the absence of detergent. However, the reduction seems to vanish in the presence of detergent during the 3rd wash. Therefore the explanation may rather be that detergent remnants exert an amplifying effect on the substrate reaction; cf. the  $+ - -$  situation seems to give a somewhat reduced signal, compared to situations with later uses of detergent. This indicates an increasing amplification with decreasing detergent “distance” from the substrate reaction, thus supporting the amplification suggestion. However, this effect by Triton X-100 was not demonstrable in the previous work <sup>1</sup>, and the complexity calls for a separate investigation, which will not be covered here.



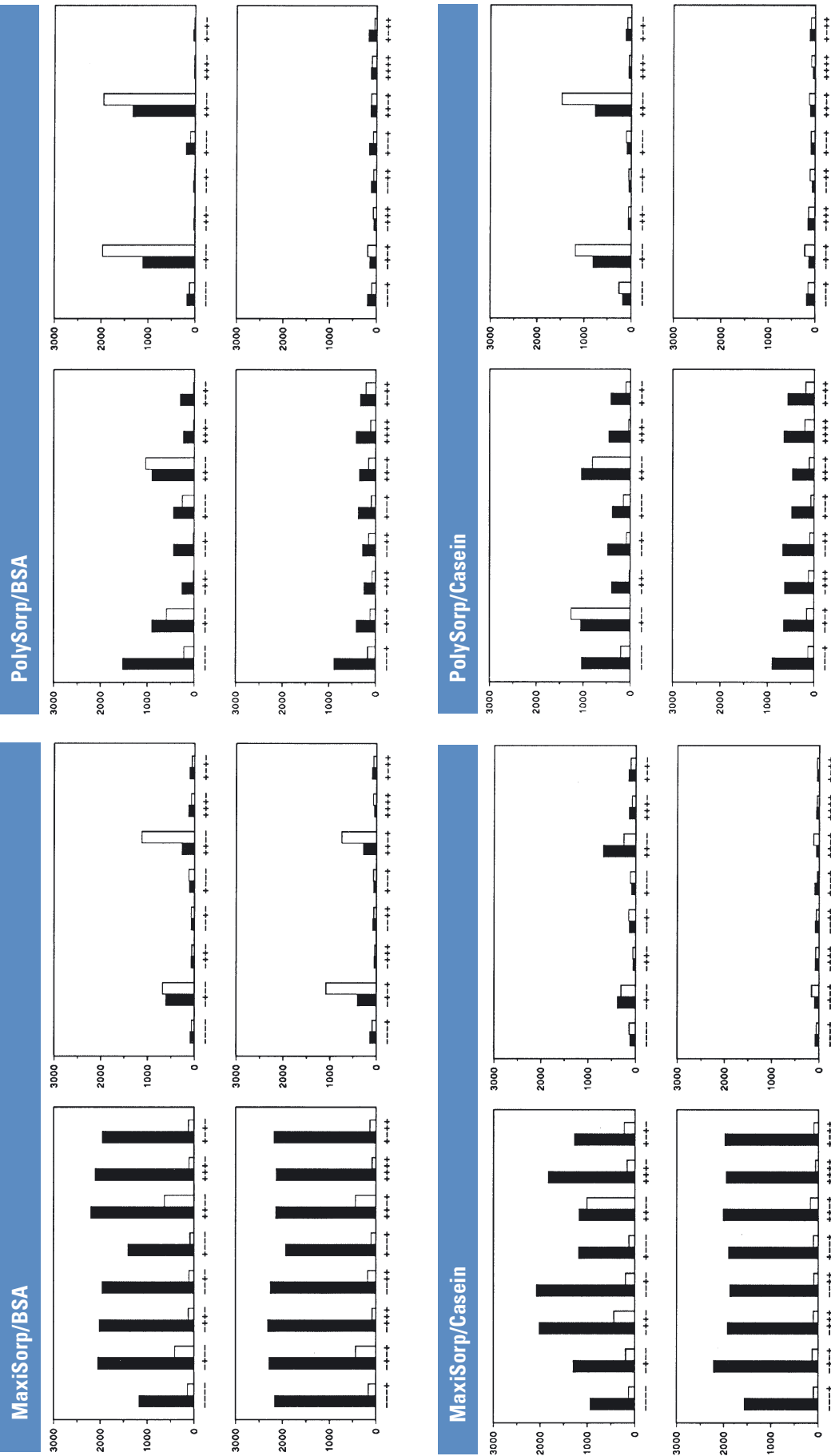
**Fig. 1**

Illustration of the presumed difficulties with use of detergent combined with blocking agent in a 2-layer sequence consisting of an immobilized capture antibody (Y-shapes) and a secondary target enzyme conjugate (Y-E). For simplicity, only the right arm antibody specificities are considered. The uninvolved specific sites of the conjugate are indicated by the small bars above the antibody arms.

**Centre above:** Surface coated with capture antibody including some loosely attached antibodies (++) which may cause sterical hindrance of some specific sites (#).

**Left:** Omission of detergent in wash after coating may let loosely attached antibody stay on the surface keeping the blocking agent (■) away from some areas [above], which by succeeding wash with detergent [middle] will be opened for unspecific attachment of target conjugate [below].

**Right:** Detergent (=) in wash after coating removes loosely attached antibody [above], but may cause labile blocking by blocking agent [middle], resulting in some unspecific attachment of target conjugate [below]. Note that the unspecifically attached conjugate may be bound firmly, possibly through the enzyme (E), i.e. it may not be washed off by detergent.



**Fig. 2** Results with Triton X-100 for MaxiSorp [left diagram blocks] and PolySorp [right diagram blocks] in concert with blocking by BSA [above] or by casein [below]. Absence or presence of detergent in the 3rd wash is presented in separate diagrams indicated by minus or plus, respectively, in the fourth position of the detergent code. Left diagrams (in the MaxiSorp and PolySorp blocks respectively) show results with target conjugate; right diagrams show results with indifferent conjugate; ■ = 1st layer present; □ = 1st layer absent. Note the unspecific signals, clearly exceeding the general backgrounds, in some -+- ( ) and +--+ ( ) situations.

O.D. mEU<sub>490</sub>

The results with casein (Fig. 2 below) very much resemble those with BSA, except that the unspecific signals can now be eliminated by detergent in the 3rd wash with both MaxiSorp and PolySorp. This indicates that casein, contrary to BSA, renders the unspecifically attached conjugate removable by detergent with both surfaces. Therefore casein seems to be a more effective blocking agent than BSA.

With Tween 20 (results not shown), regardless of the blocking agent used, no significant unspecific signals are observed in any situation. This is not surprising, since Tween 20 has been shown to exert a stable blocking effect if used just once <sup>1</sup>. In addition, the general backgrounds are reduced if the detergent is used in the 3rd wash.

With CHAPS (results not shown), like with Tween 20, no unspecific signals are observed. In this case the explanation is probably that CHAPS, contrary to the other detergents, is effectively replaced by either blocking agent (cf. Fig. 1 right). The backgrounds are somewhat higher than with the other detergents, even though they are reduced if the detergent is used in the 3rd wash. In addition, signal magnitudes are the same with both surfaces, indicating that the washing capability of CHAPS is less than that of the other detergents.

### Conclusion

The following general guidelines concerning the use of blocking agent and detergent in ELISA have been extracted from this investigation with special reference to the previous work <sup>1</sup>:

1. The optimal combination of blocking agent and detergent seems to be achieved simply by omission of detergent until wash after incubation with the last reactant. However,

detergent wash may break specific couplings in systems having weak immunologic affinities. This may be merely a question of detergent selection. The gentle CHAPS might be a suitable choice in critical systems.

2. Unspecific adsorption can be avoided if detergent is included during incubation with secondary reactant. Actually, presence of detergent in this step is an efficient substitute for a blocking step <sup>1</sup>, thus rendering a blocking step superfluous. However, the purpose of using a blocking agent may be (except to obtain coating storage stability) to avoid the co-presence of detergent and secondary reactant due to possible detergent interference with specific reactions. A simple solution to this might be just to wash after coating with Tween 20 and nothing else, since this detergent performs like a typical blocking agent <sup>1</sup>.

3. The conclusion from the previous investigation <sup>1</sup>, of using detergent in the wash succeeding coating (to wash off loosely adsorbed reactant), is obviously questionable. A desired use of detergent after coating should be limited to the wash between coating and blocking. But in this case, the blocking may not be stable, indicated by the observed blocking collapse if detergent (i.e. Triton X-100) is also used in the wash just after blocking. Again, CHAPS might fit the situation.

4. Casein is a more effective blocking agent than BSA. However, the blocking agent neutrality should always be questioned. Particularly

with casein, and especially when assaying serum for auto-immune diseases, one must take into account the risk of cross-reaction with casein antibodies remaining in the patient's serum from ingestion of milk.

In summary, the optimal way of using blocking agent with detergent is to combine a blocking step (after coating) with presence of detergent only in wash after the last reactant. The use of detergent can possibly be extended to the wash just after coating, but this seems to be more risky and demands a careful detergent choice. In this context it should be noted that different detergents may be successfully used in different steps.

This investigation reveals that the combined use of blocking agent and detergent is a matter of considerable complexity. The above statements should be taken with the proviso that the investigation is based on a simple model system which may not be representative of all ELISA systems.

### References

1. Esser P. (1990). Detergent in polystyrene ELISA. Thermo Scientific Nunc Bulletin No. 8, 1-5.
2. Jitsukawa T. et al. (1989). Increased coating efficiency of antigens and preservation of original antigenic structure after coating in ELISA. J. Immunol. Methods 116, 251-257.
3. Pratt R.P. & Roser B. (1989). Comparison of blocking agents for ELISA. Thermo Scientific Nunc Bulletin No. 7, 1-3.
4. Vogt R.F. Jr. et al. (1987). Quantitative differences among various proteins as blocking agents for ELISA microtiter plates. J. Immunol. Methods 101, 43-50.

[www.thermoscientific.com/oemdiagnostics](http://www.thermoscientific.com/oemdiagnostics)

© 2010 Thermo Fisher Scientific Inc. All rights reserved. "Tween" is a registered trademark of Uniqema Americas; "Triton" is a registered trademark of Dow Chemical; "CHAPS" is a registered trademark of Sigma-Aldrich Company; All other trademarks are the property of Thermo Fisher Scientific Inc. and its subsidiaries.

# The Surface/Volume Ratio in Solid Phase Assays

Peter Esser, M.Sc., Senior Scientist, Thermo Fisher Scientific

In a solid phase assay, e.g. ELISA, a larger surface to volume ratio implies a faster adsorption of molecules from the liquid phase, because the liquid is exposed to more surface. The primary aspect of a larger ratio is therefore that incubation times can be reduced.

In addition, a higher sensitivity may be obtained within a finite incubation time. However, using enough incubation time, a larger ratio will not increase the sensitivity, because there will normally be ample binding sites present on the liquid covered surface for eventual immobilization of all (scarce) analyte molecules.

In this work a quantitative relationship between the surface/volume ratio and adsorption rate is derived from simple adsorption kinetics modelling, verified by data simulation.

## Adsorption kinetics model

The basis of adsorptive drainage of molecules from a liquid to a solid surface is the molecules' thermal random movements by which they will eventually come within range of the various attraction forces responsible for adsorption <sup>1</sup>.

In this context adsorption forces also include biospecific affinities, as those between antibody and antigen. By an adsorbing surface is meant any surface with a number of binding sites for certain target molecules, e.g. a surface coated with a specific antibody.

If we consider IgG molecules in aqueous solution and make the following assumptions:

- a molecule that hits an unoccupied surface binding site will instantaneously and irreversibly be bound and occupy that site where

- no other molecule can be bound,
- diffusion of molecules will keep step with adsorptive depletion so that solution homogeneity is continuously maintained (see remarks below), the rate of adsorption may be expressed by a simple combination of the kinetics for a second order chemical reaction ( $A + C \rightarrow B$ ) and diffusion kinetics:  $dB_t/dt = [(A-B_t)/A] \cdot [(C-B_t)/V] \cdot [S(kD/\pi)^{1/2} \cdot t^{1/2}]$  (1)

where:

$B_t$  = number of bound molecules at time  $t$

$t$  = elapsed adsorption time = hr

$A$  = number of molecules that can be bound

$C$  = initial number of molecules in solution

$V$  = liquid volume =  $\text{cm}^3$

$S$  = adsorbing surface area =  $\text{cm}^2$

$D$  = diff. constant of IgG =  $1.44 \cdot 10^{-3} \text{ cm}^2 \cdot \text{hr}^{-1}$

$k$  = dimensionless coefficient to be determined by data simulation

In equation (1) the first two factors in square brackets, derived from common second order reaction kinetics <sup>2</sup>, express that the adsorption rate at time  $t$  is proportional to, respectively, the instantaneous fraction of the surface area available for adsorption, and the instantaneous concentration of dissolved molecules. It should be noted that the first factor, in its present form, is only valid if the molecules can be adsorbed to form a monolayer.

The last factor in square brackets, derived from common diffusion kinetics <sup>3</sup>, determines the instantaneous size of that liquid

volume in which the dissolved molecules will hit the surface by diffusion during the considered time unit (1 hr).

The second assumption above is of course more controversial, since constant homogeneity may not be a valid approximation, unless the liquid is stirred; and in this case pure diffusion transport would only take place in a thin layer next to the surface. However, exact modelling of unstirred systems, taking also back-diffusion of refused molecules into account, is rather complicated and may not be more informative than simplified modelling. Indeed, failure of data simulation by a simplified model may indirectly give significant information about factors governing the particular adsorption process.

Immediately after time zero, i.e.  $t = ]\partial t$ , eq. (1) reduces to the 'initial' adsorption rate:

$$dB_0/dt = S \cdot (C/V) \cdot (kD/\pi)^{1/2} \cdot (\partial t)^{-1/2} \quad \text{molecules/hr} \quad (2)$$

from which it plausibly appears that for a given initial concentration,  $C/V$ , the initial adsorption rate may simply be proportional to the particular surface area,  $S$ .

By integration of eq. (1), one obtains a saturation function, determining the fraction,  $E_t$ , of the surface area to which adsorption has accumulated at any time.

It appears from eqs. (4) that for a given supply/capacity ratio,  $C/A = F$ ,  $T_x$  may simply be inversely proportional to the square of the surface/volume ratio,  $P$ .

For constant  $P$ , eqs. (4a,b,c) also present  $T_x$  as a function of  $0 < F < y$ , which is depicted in Fig. 1 for  $x = 90\%$ .

$$E_t = \frac{B_t}{A} = \frac{1 - \exp\{(F-1) \cdot P \cdot 2 \cdot (kD/\pi)^{1/2} \cdot t^{1/2}\}}{1/F - \exp\{(F-1) \cdot P \cdot 2 \cdot (kD/\pi)^{1/2} \cdot t^{1/2}\}} \rightarrow \begin{cases} F & \text{for } F < 1 \\ 1 & \text{for } F \geq 1 \end{cases} \quad (3)$$

where:

$$F = C/A$$

$$P = S/V = \text{surface/volume ratio} = \text{cm}^{-1}$$

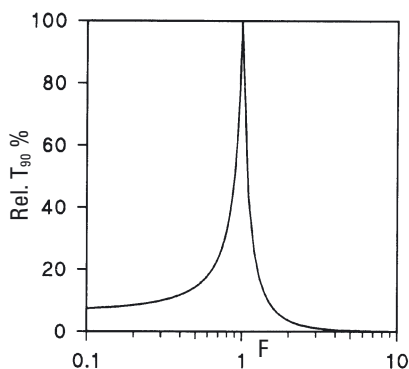
$$E_t\{F=1\} = P \cdot 2 \cdot (kD/\pi)^{1/2} \cdot t^{1/2} / [1 + P \cdot 2 \cdot (kD/\pi)^{1/2} \cdot t^{1/2}]$$

From eq. (3) one can derive the time,  $T_x$ , hr, required to obtain  $x$  % of the maximum adsorption (depending on  $F$ ):

$$T_x\{F < 1\} = P^2 \cdot (4kD/\pi)^{-1} \cdot (1-F)^{-2} \cdot [\ln\{(100-x)/F\} / (100-x)]^2 \quad (4a)$$

$$T_x\{F=1\} = P^2 \cdot (4kD/\pi)^{-1} \cdot [x/(100-x)]^2 \quad (4b)$$

$$T_x\{F > 1\} = P^2 \cdot (4kD/\pi)^{-1} \cdot (1-F)^{-2} \cdot [\ln\{(100-x)/F\} / (100-x)]^2 \quad (4c)$$



**Fig. 1**

The incubation time  $T_{90}$  in % of its maximum value, for obtaining 90% of maximum adsorption, as a function of the molecule supply/capacity ratio  $F$  according to eqs. (4). Note that  $T_{90}$  assumes its maximum value for  $F = 1$ , and approximates to a non-zero minimum value for  $F \rightarrow 0$ . See text for further explanation.

This graph has a maximum at  $F = 1$ , indicating that adsorption completion requires the longest time, if  $C$  and  $A$  are equally large, i.e. if the molecule supply just fits the surface adsorption capacity. The steepness of the curve is striking, especially that of its right branch, indicating that the surface saturation time decreases drastically at a molecule supply just slightly above the balance concentration. The graph approximates to a lower limit value, equal to 6.5% of the maximum, for  $F \rightarrow 0$ . This indicates that for arbitrarily small  $F$  values adsorption will virtually be completed within a certain, relatively short time span.

The approximate constancy of  $T_x$  for small  $F$  values renders the above stated inverse proportionality between  $T_x$  and  $P^2$  valid for a given, sufficiently small concentration (implying say  $F \leq 0.1$ ), even though  $F$  varies with variant  $P$  for constant concentration. This is a very useful implication, concerning a given

“small” concentration, meaning that if  $P$  is increased by a factor of 2, the incubation time may be reduced by a factor of 4 without reducing adsorption.

A prerequisite for the validity of these considerations is obviously that a constant value can be assigned to the coefficient  $k$ , regardless of the values of  $F$  and  $P$ .

A demand for a non-unity coefficient to the nominal  $D$  (ref. to pure water at 20°C) would not be surprising, since the operating  $D$  is depending on temperature and buffer ionic strength; but the possible influence of these parameters on  $k$  can be eliminated by just keeping them constant.

However, one could fear that  $k$  has to be changed by change of adsorption geometry, i.e. by change of  $P$ . This possibility is primarily what is to be examined by data simulation.

#### Data simulation and discussion

Thermo Scientific Nunc Immuno Modules F8 MaxiSorp (Cat. No. 468667) were incubated for

various times with IgG-HRP conjugate (Dako P128) in three series with resp. 50  $\mu\text{L}$  of 0.13  $\mu\text{g}/\text{mL}$ , 100  $\mu\text{L}$  of 0.065  $\mu\text{g}/\text{mL}$ , and 200  $\mu\text{L}$  of 0.0325  $\mu\text{g}/\text{mL}$ , followed by substrate reaction with 200  $\mu\text{L}$   $\text{H}_2\text{O}_2/\text{OPD}$  solution, amply concentrated to minimize influence by substrate diffusion. These experimental series present three different adsorption systems, characterized by the parameters given in Table 1, using the common estimate of 400  $\text{ng}/\text{cm}^2$  for Nunc™ MaxiSorp™ IgG adsorption capacity.

Since the total number of molecules is the same, and  $F$  is below unity in all three systems, signals from equal incubation times should be equally large between the systems, if not for their different  $P$  values. Consequently, any observed discrepancy would reflect differing adsorption kinetics due to the diversity of  $P$ .

For optimal data simulations (Fig. 2) by equation (3) using the proper  $F$  and  $P$  values from Table 1, a common  $k$  value = 2 was estimated. Since the final signal levels should be the same, regardless of  $P$ , due to total molecule number equality between the systems, the simulations were adjusted to a common final level estimate of 1500 mEU.

The respective  $T_{90}$  values (Table 1), calculated from eq. (4a), are not exactly comparable as a function of  $P$ , since the systems'  $F$  values are also different. However, since  $T_{90}$  (for any constant  $P$ ) is almost invariant within the present range of small  $F$  values (Fig. 1), the theoretical inverse proportionality between  $T_{90}$  and  $P^2$  approximately holds from one system to the other, as demonstrated by the uniformity of the  $T_{90} \cdot P^2$  figures in Table 1. The model's reasonably good fit to the data for constant  $k$  therefore demonstrates the validity of this claimed proportionality, at least for small  $F$  values.

Indeed, the model's good fit to the data in Fig. 2 might be due to the smallness of the  $F$  values, which implies that the adsorption

area reduction is negligible (always less than 2.6%), whereby the systems approximate the more simple first order reaction kinetics. Therefore, experimental systems were established with F values of unity order of magnitude to test the model's simulative capability and dramatic  $T_{90}$  implications in this F regime.

Thermo Scientific Nunc MicroWell plates, as above, were incubated for various times with 200  $\mu\text{L}$  1:100 mixtures of IgG-HRP conjugate (Dako P128) and pure IgG (Dako A008) in three series with total concentrations of respectively 10, 3.33, and 1.11  $\mu\text{g}/\text{mL}$ , followed by substrate reaction with 200  $\mu\text{L}$   $\text{H}_2\text{O}_2/\text{OPD}$ . These experimental series present three different systems characterized by the parameters given in Table 1.

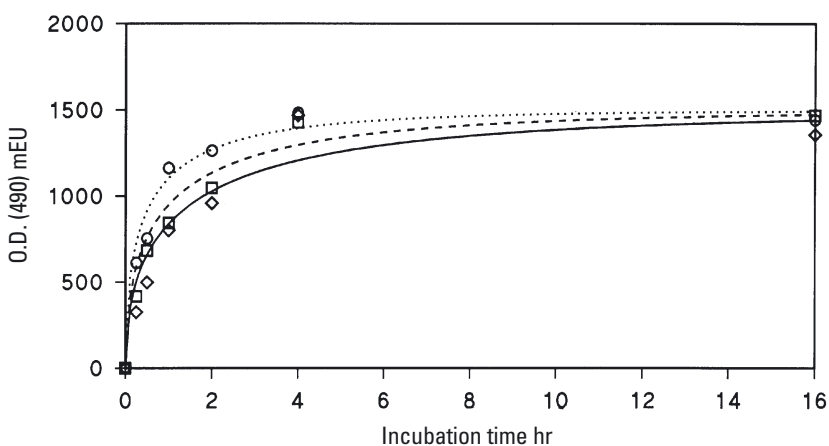
The data were simulated (Fig. 3) by equation (3) using the proper F and P values from Table 1, together with the above estimated  $k$  value =  $2\pi$ . Adjustment of the simulations to the signal units was based on a final level estimate of 400 mEU for simulation of the data having  $F = 0.36$ . This implies a common final level estimate of  $400/0.36 \approx 1110$  mEU for the two other data series, since they both have  $F > 1$ , i.e.  $E_t \rightarrow 1$  (cf. eq. (3)).

It is apparent that for fixed  $k = 2\pi$  the model fits the data reasonably well for F up to at least 1/3, but fails to fit the data for  $F \geq 1$ . Thus, for large F values there seems to be an initial excess adsorption, the more pronounced, the larger the F value, followed by some desorption during prolonged incubation. The model does not take this phenomenon into account, but it explains, by the  $T_{90}$  estimates in Table 1, the difference between the two upper data series' apparent final levels (which should be equal because  $F > 1$ ): the difference is observed, simply because complete adsorption requires an extremely long time for  $F = 1.08$  compared with  $F = 3.25$ . Thus, the data confirm the theoretical, profound variation of  $T_{90}$  when F varies around 1,

V $\text{cm}^3$	S $\text{cm}^2$	P $\text{cm}^{-1}$	Conc. $\text{g}/\text{cm}^3$	F	$T_{90}$ hr	$T_{90} \cdot P^2$ $\text{hr}/\text{cm}^2$
0.05	0.63	12.6	$0.13 \cdot 10^{-6}$	0.0258	3.0	475
0.1	0.94	9.4	$0.065 \cdot 10^{-6}$	0.0173	5.3	470
0.2	1.54	7.7	$0.0325 \cdot 10^{-6}$	0.0106	7.9	466
0.2	1.54	7.7	$1.11 \cdot 10^{-6}$	0.36	13.1	–
0.2	1.54	7.7	$3.33 \cdot 10^{-6}$	1.08	59.7	–
0.2	1.54	7.7	$10 \cdot 10^{-6}$	3.25	1.1	–

**Table 1**

Parameters for the data simulations in Fig. 2 (above figures) and Fig. 3 (below figures). See text for further explanation.



**Fig. 2**

Simulation curves of adsorption kinetics data from incubations of flat-bottomed MicroWells for various times with IgG-HRP conjugate, 50  $\mu\text{L}$  of 0.13  $\mu\text{g}/\text{mL}$  ( $\circ$ /---), 100  $\mu\text{L}$  of 0.065  $\mu\text{g}/\text{mL}$  ( $\square$ /---), and 200  $\mu\text{L}$  of 0.0325  $\mu\text{g}/\text{mL}$  ( $\diamond$ /---), according to eq. (3) using the respective F and P values from Table 1. See text for further details.

and the initial excess adsorption for the larger F values may be regarded as merely a phenomenon superimposed on basic kinetics, governed by the model. Probably the more concentrated molecules will overcrowd during their initial mass invasion of the “virgin” surface, and only after a period of molecule rearrangement and desorption of excess molecules a stable one-to-one binding between molecules and surface binding sites will be established.

Thus, it seems that for  $k = 2$  the model is basically consistent with the MicroWell™ adsorption format for any P and F values of interest. However, the possibility exists that  $k$  invariance cannot be maintained for other P transitions

than those established by changing the liquid volume in MicroWell plates. Therefore, the relevance of the inverse proportionality between incubation time and  $P^2$  was tested using a different system consisting of “startubes” ( $\otimes$ ) vs. standard tubes ( $\cup$ ).

Immuno™ StarTubes™ MaxiSorp (Cat. No. 470319) and Immuno Tubes MaxiSorp (Cat. No. 444202) were coated overnight with excess swine anti-rabbit antibody (Dako Z196), then incubated with a dilution series of rabbit antibody HRP conjugate (Dako P128), startubes for 1 hr, and standard tubes for 1, 1.5, 2.5, and 3.5 hr, followed by substrate reaction with  $\text{H}_2\text{O}_2/\text{OPD}$  solution. All liquid volumes were 350  $\mu\text{L}/$

tube, implying a  $P_{\text{S}}/P_{\text{U}}$  ratio of about 1.6<sup>4</sup>. Consequently, by using startubes instead of standard tubes, a possible reduction of the second layer incubation time by a factor of about 2.5 without reduction of signal would be expected with the smaller concentrations.

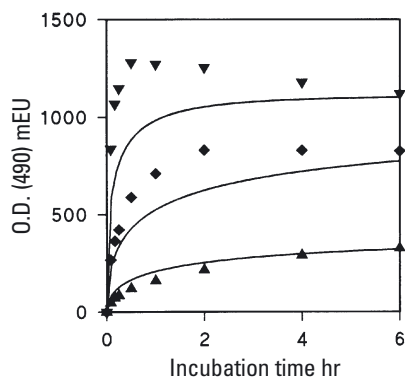
From the data in Fig. 4 it appears that at small concentrations the 1 hr startube signals lie between the 1.5 and 2.5 hr standard tube signals. This means that the incubation time can be reduced only about twice, by using startubes instead of standard tubes, rather than 2.5 times, as expected. But from the level signals at saturating concentrations, estimated to 975 mEU for startubes, and 700 mEU for standard tubes, it appears that the working surface area ratio,  $S_{\text{S}}/S_{\text{U}}$ , equal to the  $P_{\text{S}}/P_{\text{U}}$  ratio (since the volumes are equal), is  $975/700 = 1.4$ , rather than the nominal 1.6, just implying an incubation time reduction factor of about 2 instead of 2.5.

Thus, it seems to be generally consistent for obtaining a definite adsorption of molecules from small concentrations that the adsorption time is inversely proportional to the square of the surface/volume ratio, regardless of the specific geometry. This is valid also for biospecific affinity adsorption, as demonstrated by the last experiment, provided that the adsorbing densities are the same.

### Summary

From this investigation, by means of a simple adsorption kinetics model, verified by data simulation, the following general rules related to incubation time and surface/volume ratio in solid phase assays can be derived:

1. For a given concentration of molecules to be adsorbed, the initial adsorption rate is proportional to the adsorbing surface area according to eq. (2).
2. For a given molecule concentration implying sufficiently small ratios,  $F$ , between molecule supply and



**Fig. 3**

Simulation curves of adsorption kinetics data from incubations of flat-bottomed MicroWells for various times with 200  $\mu\text{L}$  1:100 mixtures of IgG-HRP conjugate and pure IgG in total concentrations of 1.11  $\mu\text{g}/\text{mL}$  ( $\blacktriangle$ ), 3.33  $\mu\text{g}/\text{mL}$  ( $\blacklozenge$ ), and 10  $\mu\text{g}/\text{mL}$  ( $\blacktriangledown$ ) according to eq. using the respective  $F$  and  $P$  values from Table 1. See text for further details.

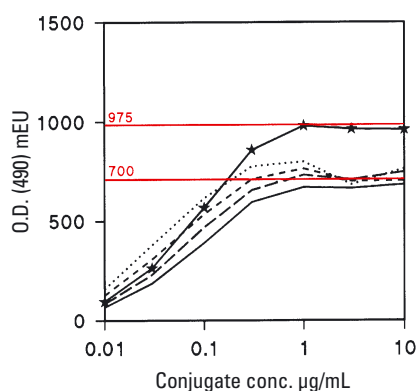
surface adsorption capacity, say  $F = 0.1$ , the incubation time  $T_x$  required to adsorb a certain percentage  $x$  of the molecules is to a good approximation inversely proportional to the square of the surface/volume ratio,  $P$ . This means that if e.g.  $P$  is increased twice, the incubation time can be reduced four times without reducing adsorption. Analytes are often consistent with small concentrations, and the approximate time required to adsorb any particular percentage of a scarce analyte can be estimated from eq. (4a) for  $F = 0$ , provided that it can potentially be adsorbed to form a monolayer.

3. Surface saturation time is extremely long if the molecule supply just fits the surface adsorption capacity, i.e. if  $F = 1$ , but it is dramatically reduced, if  $F$  is just 1.5 times larger than 1 (Fig. 1). However, in the latter case, at least by first layer

coating, a stable saturation state should be expected only after a considerable equilibration time, probably due to an initial molecule overcrowding on the surface.

Therefore, the incubation time to be saved with  $F > 1$  is questionable, and one might be better off with  $F = 1.5$  times smaller than 1, where the adsorption time is also markedly reduced, even though the surface cannot be fully saturated. In this case, one would get a better utilisation of coating molecules within a limited incubation time.

The model's simulative capability is so far limited to conditions where molecules can be adsorbed to form a monolayer. However, this will not be the case in many situations, for instance, considering a surface coated with a specific antibody, if only part of the adsorbed antibodies are active, and/or if the target molecules



**Fig. 4**

Signals for immunospecific affinity adsorption obtained by incubation of startubes for 1 hr ( $\text{—} \star \text{—}$ ) and standard tubes for 1 hr ( $\text{—}$ ), 1.5 hr ( $\text{---}$ ), 2.5 hr ( $\text{- - - -}$ ), and 3.5 hr ( $\text{- \cdot \cdot \cdot}$ ) with 350  $\mu\text{L}/\text{tube}$  of a dilution series of rabbit antibody HRP conjugate after coating with swine anti-rabbit antibody. Note that at small concentrations the 1 hr startube signals lie between the 1.5 hr and 2.5 hr standard tube signals, whereas at saturating concentrations the startube signal level (= 975 mEU) exceeds the standard tube signal level (= 700 mEU) due to the larger startube surface area. See text for further explanation.



are small compared with the antibodies. To adapt the model for such situations, the factor  $(A-B_t)/A$  in eq. (1) has to be modified by some coefficient, implying e.g. the interesting possibility of estimating the specific activity of adsorbed molecules through estimation of the coefficient by appropriate data simulation. This will be the object of further studies of adsorption kinetics to be communicated on a later occasion.

## References

1. Esser P. (1988).  
Principles in adsorption to polystyrene.  
Thermo Scientific Nunc Bulletin No. 6,1-5.
2. Atkins P.W. (1990).  
Physical Chemistry, 4th ed., 785-789.  
Oxford University Press.
3. Davies J.T. & Rideal E.K., eds. (1961).  
Interfacial Phenomena, 165-168.  
Academic Press.
4. Esser P. (1985).  
Adsorption geometry in Nunc products  
for solid phase assays.  
Thermo Scientific Nunc Bulletin No. 1,  
3-4.

# Activity of Adsorbed Antibodies

Peter Esser, M.Sc., Senior Scientist, Thermo Fisher Scientific

It is well-known that bio-macromolecules may undergo conformational changes (denaturation) during passive adsorption on synthetic surfaces and thereby lose their biological activity<sup>1</sup>.

In Thermo Scientific Nunc Bulletin No. 10<sup>2</sup> it was argued that the functional activity (i.e. the active percentage) of adsorbed capture antibodies might be estimated through mathematical model fitting to appropriate data.

In the present work the activities of polyclonal capture IgG antibodies, adsorbed on the Thermo Scientific Nunc Immuno MaxiSorp and PolySorp polystyrene surfaces, were estimated by simulation of target IgG binding data using the model modified for non-monolayer binding kinetics.

## Methods and Results

Nunc<sup>™</sup> Immuno<sup>™</sup> Plates, MaxiSorp<sup>™</sup> F96 (Cat. No. 439454), and PolySorp<sup>™</sup> F96 (Cat. No. 475094), were coated overnight with 200  $\mu\text{L}$ /well of affinity isolated swine anti-rabbit capture IgG antibody = CAB (Dako Z 400) in PBS, pH 7.2, at 5 or 0.5  $\mu\text{g}/\text{mL}$ . This established four different CAB surfaces with total antibody densities,  $Q'$  ng/ $\text{cm}^2$ , as determined by the CAB concentrations, [CAB], the surface/

volume ratio (see below), and the estimates from Thermo Scientific Nunc Bulletin No. 6<sup>3</sup> of 650 and 220 ng/ $\text{cm}^2$  for the MaxiSorp and PolySorp adsorption capacities, respectively. Thus, at [CAB] = 5  $\mu\text{g}/\text{mL}$ , the surfaces are saturated, i.e.  $Q' = 650 \text{ ng}/\text{cm}^2$  for MaxiSorp (MS-650), and  $Q' = 220 \text{ ng}/\text{cm}^2$  for PolySorp (PS-220), whereas at [CAB] = 0.5  $\mu\text{g}/\text{mL}$ , the surfaces are not saturated, i.e.  $Q' = 65 \text{ ng}/\text{cm}^2$  for both MaxiSorp (MS-65) and PolySorp (PS-65). The coatings were followed by incubation for various times with a dilution series of rabbit target IgG antibody = TAB (Dako A 008), then incubation for 1 hr with excess peroxidase conjugated swine anti-rabbit IgG antibody (Dako P 217), both in PBS with 0.05% Tween 20, and finally, substrate reaction with  $\text{H}_2\text{O}_2/\text{OPD}$ . Between the reaction steps, the wells were washed three times with PBS containing an extra 0.2 M NaCl and 0.05% Triton X-100. Using 200  $\mu\text{L}$ /well implies a covered surface area of 1.54  $\text{cm}^2$ , and a surface/volume ratio of 7.7  $\text{cm}^{-1}$ . The results are shown in Fig. 1A.

For simulation of non-monolayer TAB binding kinetics, the rate equation<sup>2</sup> has been modified by introduction of the parameter  $q$  into the first square bracket factor:

$$dB_t/dt = [(qA - B_t)/qA] \cdot [(C - B_t)/V] \cdot [S(kD/\pi)^{1/2} \cdot t^{1/2}] \quad \#1$$

which by integration gives:

$$E_t = \frac{B_t}{qA} = \frac{1 - \exp\{(F/q - 1) \cdot P \cdot 2(kD/\pi)^{1/2} \cdot t^{1/2}\}}{q/F - \exp\{(F/q - 1) \cdot P \cdot 2(kD/\pi)^{1/2} \cdot t^{1/2}\}} \rightarrow \begin{cases} F/q & \text{for } F < q \\ 1 & \text{for } F \geq q \end{cases} \quad \#2$$

where:

- $B_t$  = number of bound TAB molecules at time  $t$
- $t$  = elapsed binding time = hr
- $A$  = imaginary monolayer number of TAB molecules  $\sim 650 \text{ ng}/\text{cm}^2$
- $q$  = fraction of monolayer number of molecules that can be bound
- $C$  = initial number of TAB molecules in solution
- $V$  = liquid volume = 0.2  $\text{cm}^3$
- $S$  = covered surface area = 1.54  $\text{cm}^2$
- $D$  = diffusion constant of IgG = 1.44  $\cdot 10^{-3} \text{ cm}^2 \cdot \text{hr}^{-1}$
- $k$  = dimensionless coefficient =  $2\pi^2$
- $E_t$  = fraction of  $qA$  occupied at time  $t$
- $F = C/A$
- $P = S/V = \text{surface/volume ratio} = 7.7 \text{ cm}^{-1}$

The assumption is that if only a proportion,  $qA$ , of the potential monolayer CAB number is active, the TAB will accumulate to maximally the same proportion in the 2nd layer, thus reflecting the active CAB. The introduction of  $q$  into equation #1 is equivalent to assuming that a smaller monolayer TAB number than  $A$  is accumulating on a proportionally smaller surface. The interpretation of this is that on one hand the probability of an impinging TAB molecule hitting an available binding site is reduced, but on the other hand every hitting molecule will contribute proportionally more to saturation, thus the saturation rate will be proportionally increased.

Hence, the proportions of active CAB in the first layer to the total potential monolayer number were estimated by the respective  $q$  values

giving the optimal TAB binding curve fittings by equation #2.

The parameters obtained by these simulations are included in Table 1A, where the F values, common to the four CAb surfaces, were determined using the previous estimate of 650 ng/cm<sup>2</sup> <sup>3</sup> for the densest monolayer packing of IgG. The simulations are shown in Fig. 1B.

## Discussion

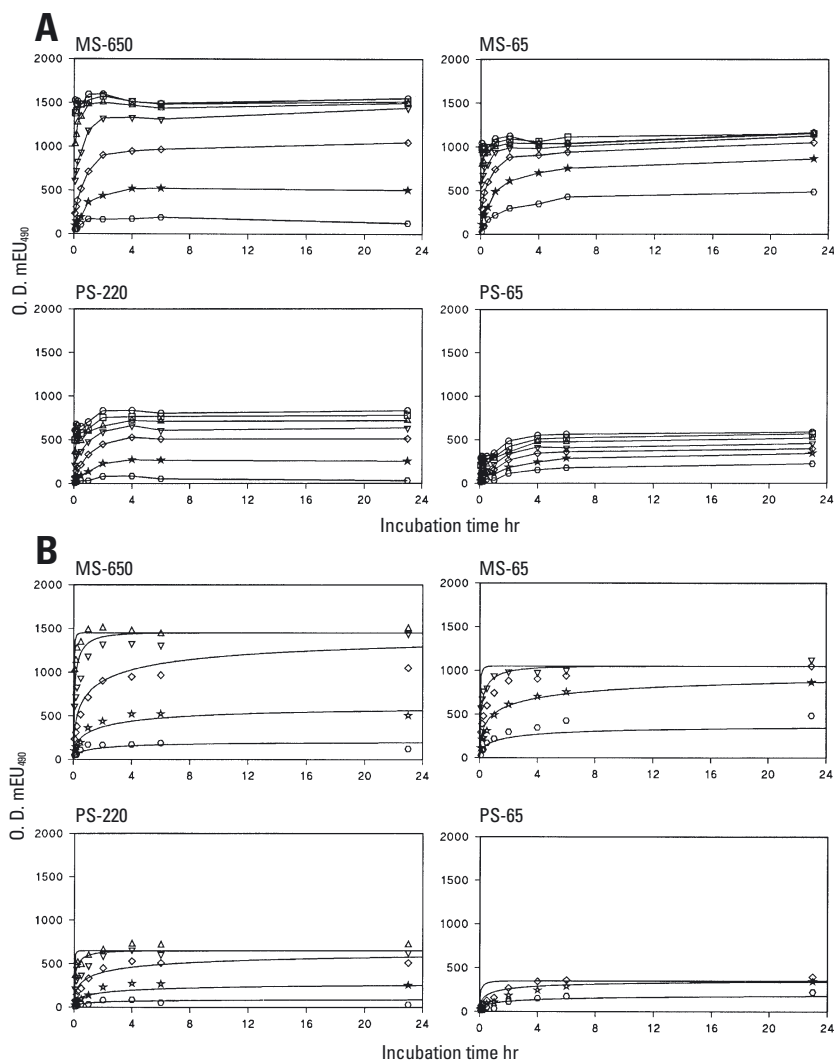
The estimated *q* values were converted into percentages of active CAb in Table 1B (ACD%) using the MaxiSorp and PolySorp adsorption capacities of 650 and 220 ng/cm<sup>2</sup>, respectively. The active percentages are surprisingly low. For saturated MaxiSorp (MS-650) the value is only 2%, which is somewhat lower than the analogous estimate of 5-10% by others 1, whereas for saturated PolySorp (PS-220) the value is 6%. However, for non-saturated MaxiSorp (MS-65) the active percentage is increased to 8%, whereas for non-saturated PolySorp (PS-65) it remains almost unchanged (5%). This may be explained by the different IgG bedding patterns, assumed previously <sup>3</sup>, on the two surfaces. On MS-650 the molecules are standing in tight palisades, whereas on PS-220 they have settled in a more loose pattern, implying that sterical hindrance is prevalent on

the former, but eased on the latter. However, on MS-65 and PS-65 there is ample unoccupied surface, wherefore sterical hindrance is eased in both cases.

Consequently, the active percentage is much higher (four times) on MaxiSorp at the lowered CAb surface density, but almost unchanged on PolySorp. From the fractional densities, *q*, of active molecules, equivalent to the mass densities, *Q* ng/cm<sup>2</sup>, calculated in Table 1B, it appears that MS-650 and PS-220 have the same densities of active molecules. This must, however, be seen as a coincidental peculiarity, consistent with the fact that the optimal simulations of the TAB binding kinetics on these surfaces demanded the same model parameters (except the same maximum signals, see below). Thus, the PS-220 simulation curves

can be produced by multiplying the MS-650 curves by the quotient between the respective maximum signals: 650/1450. On the other hand, it appears that at the same non-saturating total densities on the two surfaces, the active density is almost twice as high on MS-65 as on PS-65. This seems to confirm the previously proposed theory 3, that on MaxiSorp more CAb molecules will be favorably oriented than on PolySorp. The surface scenarios corresponding to these considerations are illustrated in Fig. 3 using the molecular density-distance relationship exposed in Fig. 2.

More surprising and important than the observed low CAb activities are the differences in relative signal magnitudes calculated per bound TAB molecule (RTS in Table 1B). Thus, it appears that for both MaxiSorp



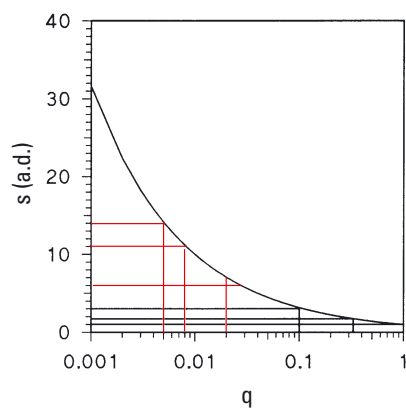
**Fig. 1**

A: Binding kinetics data from incubations for various times of a 1:3 target IgG dilution series, 10.0 μg/mL (○), 3.33 μg/mL (□), 1.11 μg/mL (●), 0.370 μg/mL (▽), 0.123 μg/mL (◇), 0.0411 μg/mL (☆), and 0.0137 μg/mL (○), in flat-bottomed MaxiSorp and PolySorp MicroWell plates saturated with capture IgG (resp. MS-650 and PS-220), and non-saturated (resp. MS-65 and PS-65). The bound target IgG was detected by subsequent incubation with excess anti-target peroxidase conjugate, and substrate reaction with H<sub>2</sub>O<sub>2</sub>/OPD. The data are the mean results from three independent experiments, each one with mutually comparable signals.

All signals were subtracted by respective backgrounds from blinds without target. B: Simulations of the data in A using eq. #2 with the parameters given in Table 1A. See text for further explanation.

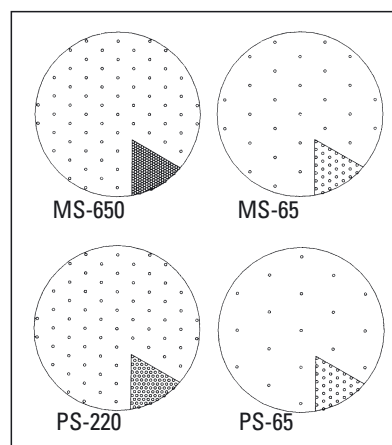
and PolySorp the RTS is doubled by changing from the saturated to the non-saturated surface, and furthermore, the RTS is generally doubled by changing from PolySorp to MaxiSorp. Although the factor 2 seems to occur everywhere in this complex, attempts to explain this by the possibility that the binding capacity of an active CAb molecule may vary between one and two target molecules have been unsuccessful. It should be noted that this possibility has been ignored in all other considerations, assuming that active CAb molecules bind the same amount of target, regardless of the surface in question. At first, it seems most probable that these differences are due to the detection system, assuming that the conjugate access to the bound TAb molecules and/or the conjugate enzyme expression may vary from one surface to the other. The higher signals with non-saturated surfaces might be due to a better conjugate access to the TAb molecules, which are probably surrounded by more free space at sub-monolayer CAb densities, whereas the higher signals with MaxiSorp could result from a better conjugate bedding in favor of enzyme expression. Whatever the true explanations are, there seems to be a double advantage in using non-saturated instead of saturated MaxiSorp, since not only a far better utilisation of the CAb is achieved, but also a better sensitivity in the sandwich assay. Unfortunately, adsorbed molecules would generally not be stable for a prolonged time on non-saturated surfaces, especially if the surface is dried (for storage). However, in the light of the situation with PolySorp, this disadvantage can probably be remedied by co-adsorption of an appropriate amount of indifferent, supporting molecules, e.g. albumin<sup>4</sup>.

From the empirical data in Fig. 1A it appears that with MaxiSorp all target concentrations above a certain (saturating) value yield the same maximum binding level, indicating that the amount of active CAb on this surface is



**Fig. 2**

Relationship between surface molecule density,  $q$ , in fraction of monolayer density, and minimum distance,  $s$ , in average IgG diameters (a.d.), based on the approximation that the molecules are globular and distributed in a hexagonal pattern, implying  $s = (1/q)^{1/2}$  a.d. If the IgG Stokes radius of 5 nm is used for the average IgG radius, then 1 a.d. = 10 nm. The red line interpolations give the  $s$  values corresponding to the active density  $q$  values in Table 1A; the black line interpolations give the  $s'$  values corresponding to the total density  $q'$  values of 650/650 = 1 for MS-650, 220/650 = 0.33 for PS-220, and 65/650 = 0.1 for MS-65 and PS-65, using the figure 650 ng/cm<sup>2</sup> for the densest monolayer packing of IgG. The interpolations have been used in Fig. 3.



**Fig. 3**

Schematic illustration of the densities of active capture IgG (small circles) compared with the total densities (in sections) on approx. 25·10<sup>-10</sup> cm<sup>2</sup> (large circles) of the four capture IgG surfaces. The molecule diameters and distances are drawn to the same scale according to the interpolations in Fig. 2. Note that at the different saturating total densities, i.e. MS-650 ( $s' = 1$  a.d.) vs. PS-220 ( $s' = 3^{1/2}$  a.d.), the active densities are equal ( $s = 7$  a.d.), whereas at the equal non-saturating total densities ( $s' = 3$  a.d.) the active densities are different, i.e. MS-65 ( $s = 11$  a.d.) vs. PS-65 ( $s = 14$  a.d.). See Fig. 2 and text for further explanation.

<b>A</b>		MS-650		MS-65		PS-220		PS-65	
MXS mEU		1450		1050		650		350	
$q$		0.02		0.008		0.02		0.005	
[TAb] µg/mL	F	F/q	q/F	F/q	q/F	F/q	q/F	F/q	q/F
10.0	2.00	–	–	–	–	–	–	–	–
3.33	0.666	–	–	–	–	–	–	–	–
1.11	0.222	11.1	0.0901	–	–	11.1	0.0901	–	–
0.370	0.0740	3.70	0.270	9.25	0.108	3.70	0.270	–	–
0.123	0.0247	1.23	0.810	3.09	0.324	1.23	0.810	4.94	0.202
0.0411	0.00822	0.411	2.43	1.03	0.973	0.411	2.43	1.64	0.608
0.0137	0.00274	0.137	7.30	0.343	2.92	0.137	7.30	0.548	1.82
<b>B</b>									
ACD	%	2		8		6		5	
	Q ng/cm <sup>2</sup>	13		5		13		3	
RTS		2		4		1		2	
$s$ (a.d.)		7		11		7		14	

**Table 1**

A: Parameters estimated for the optimal simulations in Fig. 1B of the kinetics data in Fig. 1A of TAb (target IgG) binding on the four CAb (capture IgG) coated surfaces: MS-650 = saturated MaxiSorp, MS-65 = non-saturated MaxiSorp, PS-220 = saturated PolySorp, PS-65 = non-saturated PolySorp; MXS = maximum signal;  $q$  = active fraction of the densest monolayer packing (650 ng/cm<sup>2</sup>); [TAb] = TAb concentration;  $F = [TAb]/(0.650 \cdot P)$ .  
B: Derivatives from the data simulations in Fig. 1B; ACD% = active CAb density in % of total CAb density = active percentage = 100· $q$ ·650/(650, 220, or 65)%;  $Q$  = active CAb density in mass =  $q$ ·650 ng/cm<sup>2</sup>; RTS = relative TAb signal = MXS/(Q·MXSPS-220/QPS-220);  $s$  = average minimum distance between active CAb molecules in average IgG diameters (a.d.), estimated by interpolation in Fig. 2. See text for further explanation.

independent of the amount of target (as basically anticipated). On the contrary, with PolySorp every concentration has its own level, suggesting that more and more CAb is activated with increasing amounts of target. This may be explained by the different CAb adsorption mechanisms, assumed previously<sup>3</sup>, for the two surfaces. Thus, the MaxiSorp adsorption, including hydrogen bonds, presents a more stable orientation of the capture IgG molecules, whereas the purely hydrophobic PolySorp adsorption presents a more labile orientation, susceptible to some activating alteration by a “pull” from (abundant) target molecules. The fact that the PolySorp CAb surfaces at the higher target concentrations present binding rates with marked initial delays compared to the model kinetics (Fig. 1AB) supports this theory, since such molecular rearrangements prior to binding would probably take additional time. It also makes sense, therefore, that the activation and delays seem more pronounced with the non-saturated PolySorp, since the capture molecules would probably be more free to rearrange under these conditions.

This maximum level lability obviously endows the  $q$  estimations for PolySorp with considerable uncertainties implying that the derived PolySorp characteristics and their comparison with those of MaxiSorp must be taken with due reservations.

### Summary

Analytical simulations of the binding kinetics of rabbit target IgG (TAb) from a sandwich assay utilizing affinity isolated anti-rabbit capture IgG (CAb) have revealed some useful indications concerning the functional activity of CAb adsorbed to the Immuno MaxiSorp or PolySorp surfaces:

1. The active CAb densities are equal on monolayer-saturated MaxiSorp and PolySorp surfaces, which translate

into only 2% active CAb on MaxiSorp, but 6% on PolySorp, due to the different adsorption capacities of 650 and 220 ng/cm<sup>2</sup>, estimated for MaxiSorp and PolySorp respectively<sup>3</sup>. This corresponds to an active CAb mass density of about 13 ng/cm<sup>2</sup> (or 0.085 pmole/cm<sup>2</sup>), meaning that with 200  $\mu$ L volumes in a Thermo Scientific Nunc MicroWell, implying 1.54 cm<sup>2</sup> covered surface, the attainable maximum signal will be reached with a TAb concentration of  $13 \times 1.54 \times 5 = 100$  ng/mL (or with 0.65 pmole of an analyte) on both surfaces, assuming that only one binding site per active CAb is functional.

2. By use of non-saturated surfaces (65 ng/cm<sup>2</sup>), i.e. 0.12  $\times$  saturated MaxiSorp and 0.32  $\times$  saturated PolySorp, the active percentage is increased 4 times to 8% (corresponding to 5 ng/cm<sup>2</sup>) on MaxiSorp, but remains almost unchanged at 5% (corresponding to 3 ng/cm<sup>2</sup>) on PolySorp. This suggests that on saturated MaxiSorp, contrary to PolySorp, there exists a heavy sterical hindrance, which is relaxed by dilution, but probably also a high stability of the tightly packed molecules. Thus, it seems that with MaxiSorp a much better utilisation of CAb can be achieved, if the surface is not saturated. However, this might create (storage) stability problems, which calls for an optimization study of the use of indifferent, stabilizing molecules (quality and quantity) for co-adsorption with the CAb.

3. The sandwich assay sensitivities are about twice as high on non-saturated as on saturated MaxiSorp or PolySorp surfaces, perhaps due to a better conjugate access to the target molecules on non-saturated surfaces. However, the phenomenon has later been approached with another explanation based on steric hindrance<sup>5</sup>. In addition,

the sensitivities are about twice as high on MaxiSorp as on PolySorp, possibly due to a better enzyme expression on MaxiSorp. Thus, compared with the other surfaces, the non-saturated MaxiSorp possesses the double advantage of a higher target detection sensitivity in addition to a better capture IgG utilization, at least for the present assay configuration. This points out the importance of including an optimization of the 1st layer coating in assay construction, and of investigating the conditions about non-saturated surfaces in general.

4. Because the active CAb percentage is higher on MaxiSorp than on PolySorp at equal levels of non-saturation, it also follows that more CAb molecules must be favourably oriented on MaxiSorp, which confirms the adsorption theory previously proposed<sup>3</sup>. The data also suggest that the CAb orientation is more stable on MaxiSorp, since on PolySorp it appears to be dependent on the concentration of added TAb.

In conclusion, the investigation described here indicates that a small active percentage of CAb is an inherent consequence of CAb immobilization by passive adsorption, and the percentage will be uniformly low for polystyrene surfaces of comparable quality among the various commercial manufacturers<sup>1</sup>. However, it should be noted that even though affinity isolated CAb has been utilized, the present active percentages hardly reflect the inactivating effect of immobilization only, since some activity has no doubt been lost during affinity purification<sup>5</sup>. The relevance of selecting the dedicated MaxiSorp surface for CAb immobilization has been confirmed.

## References

1. Butler, J.E., Ni L., Nessler R., Joshi K.S., Suter M., Rosenberg B., Chang, J., Brown W.R. & Cantarero L.A. (1992).  
The physical and functional behaviour of capture antibodies adsorbed on polystyrene.  
J. Immunol. Methods 150, 77-90.
2. Esser P. (1991).  
The surface/volume ratio in solid phase assays.  
Thermo Scientific Nunc Bulletin No. 10, 3-6.
3. Esser P. (1988).  
Principles in adsorption to polystyrene.  
Thermo Scientific Nunc Bulletin No. 6, 1-5.
4. Jitsukawa T., Nakajima S., Sugawara I. & Watanabe H. (1989).  
Increased coating efficiency of antigens and preservation of original antigenic structure after coating in ELISA.  
J. Immunol. Methods 116, 251-257.
5. Esser P. (1994).  
Comparison of affinity-isolated and non-isolated antibodies used as capture antibodies in ELISA.  
Thermo Scientific Nunc Bulletin No. 12, 7-9.
6. Butler J.E., Ni L., Brown W.R., Rosenberg B., Chang J. & Voss E.W. Jr. (1993).  
The immunochemistry of sandwich ELISA. VI. Greater than ninety percent of monoclonal and seventy-five percent of polyclonal anti-fluorescyl capture antibodies (CAbs) are denatured by passive adsorption.  
Mol. Immunol.

[www.thermoscientific.com/oemdiagnostics](http://www.thermoscientific.com/oemdiagnostics)

© 2010 Thermo Fisher Scientific Inc. All rights reserved. "Triton" is a registered trademark of Dow Chemical Company and "Dako" is a registered trademark of Dako Denmark A/S. All other trademarks are the property of Thermo Fisher Scientific Inc. and its subsidiaries.

# Effects of Enlarged Surface / Volume Ratio in Solid Phase Assays

## Documented on Basis of Thermo Scientific Nunc StarWell Module

Peter Esser, M.Sc., Senior Scientist, Thermo Fisher Scientific

Thermo Scientific Nunc C8 StarWell Module consists of MicroWell reaction wells equipped with eight inside fins. As a result, the liquid covered surface area is increased by a factor ranging from 1.27 to 1.52, depending on the liquid volume (50  $\mu$ L), when compared to standard, flat-bottom F-wells.

In a solid phase assay, e.g. ELISA, a larger surface to volume ratio implies a faster adsorption (immobilization) of molecules from the liquid phase.

According to adsorption kinetics modelling 1, incubation times can be reduced by a factor equal to the square of the surface/volume increase factor, without reducing adsorption. Consequently, by using Nunc™ StarWell™ instead of F-well, incubation times can be reduced by a factor ranging from 1.6 to 2.3, depending on the liquid volume.

This article documents the StarWell versus F-well geometry and performance.

### StarWell Geometry

The involved StarWell dimensions of interest are presented with the essential design in Fig. 1.

The key to StarWell geometry is the liquid height vs. volume relationship. However, the StarWell liquid heights cannot be determined by explicit calculation from the volumes. Therefore, the experimental StarWell to F-well OD relationship in Fig. 2 was utilized in conjunction with the calculated F-well liquid heights in Fig. 3, assuming that the geometric

heights are proportional to the OD readings.

In Fig. 3, the plot of the calculated <sup>2</sup> F-well liquid heights ( $H^{\square}$ ) vs. the respective volumes ( $V$ ) was approximated by the line:

$$H^{\square} = 0.0282V + 0.2 \text{ mm} \quad \#1$$

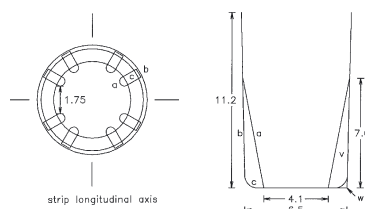
In Fig. 2, the plot of the experimental StarWell to F-well OD ratios ( $OD^*/OD^{\square}$ ) vs. the respective volumes in log-scale was found to be approximately linear by the equation:

$$OD^*/OD^{\square} = -0.22\log V + 1.55 \quad \#2$$

That is, for a given liquid volume, the StarWell liquid height is larger than the F-well liquid height by this factor due to the liquid displaced by the StarWell fins.

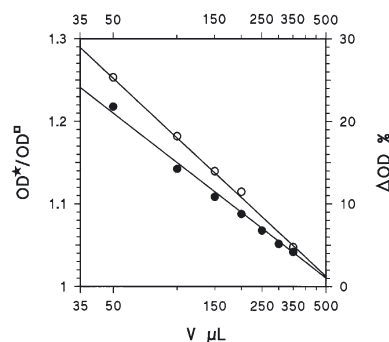
Consequently, the StarWell liquid height ( $H^*$ ) is determined by the product of #1 and #2:

$$H^* = (0.0282V + 0.2)2(-0.22\log V + 1.55) \text{ mm} \quad \#3$$



**Fig. 1** Inner design and dimensions (in mm) of StarWell, seen from above (left), and in profile (right).

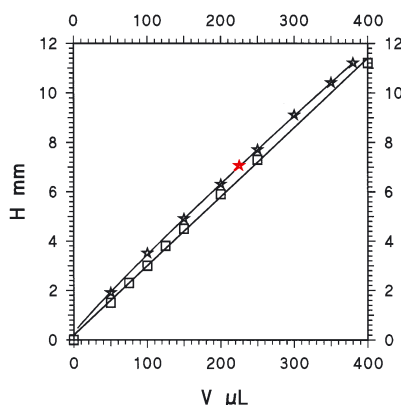
The fin front sides (a) are assumed to compensate for the parts of the "cylindrical" well surface occupied by the rear sides (b), whereas the parts of the well bottom occupied by the fin feet (c) remain uncompensated. Hence, if an estimated 0.06 cm<sup>2</sup> total feet area is taken from the flat bottom area of 0.33 cm<sup>2</sup>, the fin net surface area is determined purely by the triangular fin sides (v) subtracted by the small, rounded corner "wings" (w), i.e. in total:  $162(v-w) = 0.65 \text{ cm}^2$ . Note that the free reading window between the fins fulfils the need for a minimum of a 4 mm diameter. The larger (bottom) distances of 1.75 mm between the fins along and across the longitudinal axis of the strip allow for access of common 1.6 mm instrumentation needles, aligned in these directions (e.g. Thermo Scientific Nunc Immuno Wash 8 and 12, Cat. Nos. 470173 and 45492).



**Fig. 2** StarWell to F-well OD ratio ( $OD^*/OD^{\square}$ ), and corresponding increment ( $\Delta OD$ ), due to the StarWell fins' elevation of liquid heights, vs. volume ( $V$ ). The measurements were made in "virgin" wells with converted peroxidase substrate solution, containing no detergent ( $\bullet$ ), or containing detergent ( $\circ$ ). A downward liquid surface curvature was formed by presence of detergent, but not by absence of detergent. The semi-logarithmic plots were approximated by the straight lines according to the ratio equations #2 and #11, respectively. The application of #2, representing no curvature formation, is obviously the most relevant for geometric liquid height estimation. See text and Fig. 7 for further explanation.

yielding the total fin height = 7 mm when  $V \approx 225 \mu\text{L}$ , i.e. the volume just covering the fins. This equation was utilized to calculate the  $H^*$  values in Figs. 3 and 4, and in Table 1.

By fixing the StarWell bottom area ( $S_{\text{bot}}^*$ ) at  $0.27 \text{ cm}^2$  (Fig. 1), the fin surfaces' net area contributions are determined by their triangular sides, whose sum area ( $S_{\text{fin}}^*$ ) at a given liquid height can be expressed by their total sum area =  $0.65 \text{ cm}^2$ ,



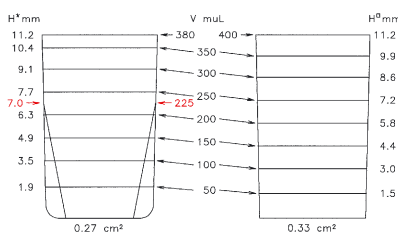
**Fig. 3** Liquid height (H) vs. liquid volume (V), for StarWell (\*), and for F-well (□). The  $H^{\square}$  calculations from ref. 2 were approximated by the straight line according to #1, and the  $H^*$  curve and selected values were calculated from #3. The red signed point corresponds to  $H^* = 7.0 \text{ mm}$  for  $V = 225 \mu\text{L}$ , the volume just covering the StarWell fins (Fig. 4).

their total height = 7 mm, and the given liquid height ( $H^*$ ):

$$S_{\text{fin}}^* = 0.652[10/7+(7-H^*)/10]2H^*/10 \text{ cm}^2 \quad \#4$$

yielding the maximum  $S_{\text{fin}}^* = 0.65 \text{ cm}^2$  when  $H^* = 7 \text{ mm}$ , corresponding to  $V = 225 \mu\text{L}$ . Thus, for V up to  $225 \mu\text{L}$ , the fin surfaces contribute with the area determined by #4, and for V above  $225 \mu\text{L}$ , their contribution is constant =  $0.65 \text{ cm}^2$ .

The remaining StarWell surface area is determined by the covered



**Fig. 4** Liquid heights (H) for selected liquid volumes (V), and bottom surface areas, for StarWell (left), and for F-well (right). The StarWell and F-well heights were calculated from #3 and #1, respectively, except the common total height, which is the measured well depth average. Note that the total StarWell liquid volume is less than the total F-well volume by  $20 \mu\text{L}$ , representing the StarWell fins' total liquid displacement.

cylindrical part of an F-well filled to the given height ( $H^*$ ).

In Fig. 5, the plot of the calculated  $S^{\square}$  F-well surface areas ( $S^{\square}$ ) vs. the respective volumes was approximated by the line:

$$S^{\square} = 0.0062V + 0.33 \text{ cm}^2 \quad \#5$$

By subtraction of the F-well bottom area =  $0.33 \text{ cm}^2$  and insertion of  $V = (H^{\square} - 0.2)/0.028$ , derived from #1, this line transforms approximately to the analogous line:

$$S^{\square} - 0.33 = 0.2142H^{\square} \text{ cm}^2 \quad \#6$$

determining the cylindrical area of an F-well by the liquid height.

Consequently, the "cylindrical" area of a StarWell ( $S_{\text{cyl}}^*$ ) is determined by replacing  $S^{\square} - 0.33$  by  $S_{\text{cyl}}^*$ , and  $H^{\square}$  by  $H^*$  (determined by #3), in #6:

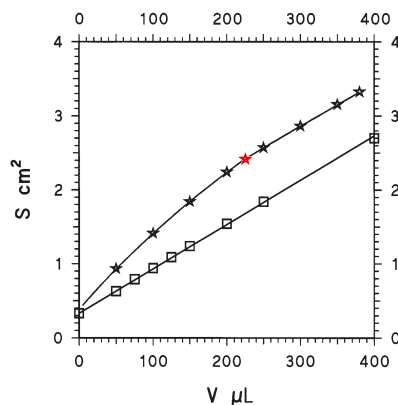
$$S_{\text{cyl}}^* = 0.2142H^* \text{ cm}^2 \quad \#7$$

The total area ( $S^*$ ) of the liquid covered StarWell surface is finally determined by the sum of  $S_{\text{bots}}^*$ ,  $S_{\text{cyl}}^*$  and  $S_{\text{fin}}^*$  (cf. #4):

$$S_{\leq 225}^* = 0.27 + 0.2142H^* + 0.65T[10/7+(7-H^*)/10]TH^*/10 \text{ cm}^2 \quad \#8a$$

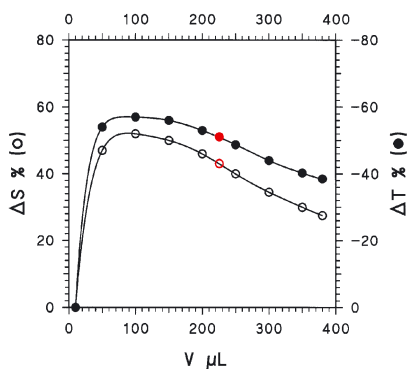
V $\mu\text{L}$	H* mm	S* $\text{cm}^2$	S*/V $\text{P}^* \text{ cm}^{-1}$	$\Delta S_f \Delta P$ %	$\Delta T$ %	$\Delta OD$ %	P* x K <sub>IgG</sub> $\mu\text{g}/\text{ml}$	
							MS	PS
50	1.9	0.93	18.6	47	-54	25.2	12.1	4.1
100	3.5	1.41	14.1	52	-57	18.0	9.2	3.1
150	4.9	1.84	12.3	50	-56	13.8	8.0	2.7
200	6.3	2.24	11.2	46	-53	10.8	7.3	2.5
225	7.0	2.42	10.8	43	-51	9.5	7.0	2.4
250	7.7	2.57	10.3	40	-49	8.4	6.7	2.3
300	9.1	2.86	9.5	34	-44	6.5	6.2	2.1
350	10.4	3.15	9.0	29	-40	4.9	5.9	2.0
380	11.2	3.32	8.7	27	-38	4.1	5.7	1.9

**Table 1** StarWell parameters for selected liquid volumes (V). The figures written in red correspond to  $V = 225 \mu\text{L}$ , the volume just covering the StarWell fins.  $H^*$  = liquid height (#3).  $S^*$  = liquid covered surface area (#8a,b).  $\Delta S_f$  = StarWell to F-well surface increment (#9).  $P^* = S^*/V$  = surface/volume ratio.  $\Delta P$  = StarWell to F-well surface/volume increment =  $\Delta S$  for equal volumes.  $\Delta T$  = possible minimum incubation time reduction (#10).  $\Delta OD$  = StarWell to F-well OD reading increment due to the liquid height elevation (#12).  $P^* \times 2K_{\text{IgG}}$  = surface saturating IgG concentrations for MaxiSorp (MS) and PolySorp (PS) surface qualities, where  $K_{\text{IgG}}$  stands for the MS and PS IgG adsorption capacities of  $0.65$  and  $0.22 \mu\text{g}/\text{cm}^2$ , respectively. For intermediate values is referred to the respective equations, or to interpolations in the respective figures. Note that the reading volume will be larger than the test volume, if an additional volume of enzyme inactivating solution is used.



**Fig. 5** Liquid covered surface (S) vs. liquid volume (V) for StarWell (\*), and for F-well (□). The  $S^{\square}$  calculations from ref. 2 were approximated by the straight line according to #5. The  $S^*$  curve and selected values were calculated from #8a,b by insertion of #3. The red signed point corresponds to the liquid covered StarWell surface area for  $V = 225 \mu\text{L}$ , the liquid volume just covering the StarWell fins.





**Fig. 6** StarWell to F-well increment ( $\Delta S$ ) of the liquid covered surface area, and minimum incubation time reduction ( $\Delta T$ ), vs. liquid volume ( $V$ ). The selected values were calculated from #9 and #10, respectively, on the basis of #8a,b and #5, and the curves were visually fitted. The red signed points correspond to the respective values for  $V = 225 \mu\text{L}$ , the liquid volume just covering the StarWell fins. Note that the curves have numerical maxima at a volume around  $100 \mu\text{L}$ , consistent with the fact that the invariable bottom areas count more and more in the total areas with decreasing volume. Eventually,  $\Delta S$  and  $\Delta T$  change sign when the volume approximates zero, due to the larger F-well than StarWell bottom surface area, i.e.,  $0.33 \text{ cm}^2$  and  $0.27 \text{ cm}^2$ , respectively (Fig. 1).

$$S^*_{\leq 225} = 0.27 + 0.214TH^* + 0.65 \text{ cm}^2 \quad \#8b$$

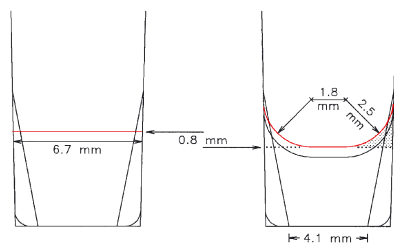
where  $S^*_{\leq 225}$  is valid for  $H^* \leq 7 \text{ mm}$  (or  $\leq 225 \mu\text{L}$ ), and  $S^*_{\leq 225}$  is valid for  $H^* \leq 7 \text{ mm}$  (or  $V \leq 225 \mu\text{L}$ ). By insertion of  $H^*$ , determined by #3, these equations determine  $S^*$  by the volume, and were utilized as such to calculate the  $S^*$  values in Fig. 5 and Table 1.

Further, the StarWell to F-well area increment ( $\Delta S$  %), equal to the surface to volume increment ( $\Delta P$  %) for equal volumes, and the possible (minimum) incubation time reduction ( $\Delta T$  %), (cf. StarWell Performance below), are determined by the ratio between #8a,b and #5 for discrete volumes:

$$\Delta S = 100T(S^*/S^{\square}-1) \% \quad \#9$$

$$\Delta T = -100T[1-1(S^*/S^{\square})^2] \% \quad \#10$$

These equations were utilized to calculate the  $\Delta S$  and  $\Delta T$  values in Fig. 6 and Table 1.



**Fig. 7** Geometric liquid heights (left), and liquid heights determined by formation of a liquid surface curvature (right), estimated according to the text calculations, for  $150 \mu\text{L}$  liquid volume in StarWell (red surface lines), and in F-well (black surface lines). The hatched area represents the assumed curvature profile enclosing the volume corresponding to the liquid height difference of  $0.8 \text{ mm}$ , when rotated  $360^\circ$  along the well circumference. Note that the plane reading area diameter is reduced from  $4.1 \text{ mm}$  (of the well bottom reading window) to about  $1.8 \text{ mm}$  of the liquid surface due to the curvature formation. See text and Fig. 2 for further explanation.

### Geometry Discussion

The geometric liquid heights may not be identical with the real heights due to formation of a liquid surface curvature (Fig. 2). This has implications for the real liquid covered surface areas and for the reading liquid heights. See Fig. 7.

The formation of a liquid surface curvature depends on the liquid composition, especially the presence of detergent, as well as on the well surface character. With a standard  $0.05\%$  detergent content in the liquid, or after a standard, three layer IgG sandwich procedure, a liquid surface curvature is formed. Therefore, the data in Fig. 2, obtained by presence of detergent ( $OD^*/OD^{\square}_{det}$ ), may represent the most likely StarWell to F-well OD increase that would be experienced in the majority of cases. These data were approximated by the equation:

$$OD^*/OD^{\square}_{det} = -0.242 \log V + 1.66 \quad \#11$$

corresponding to the increment:

$$\Delta OD = (-0.2422 \log V + 1.66 - 1) 2100 \% \quad \#12$$

Thus, equation #12 was utilized to calculate the OD values in Table 1.

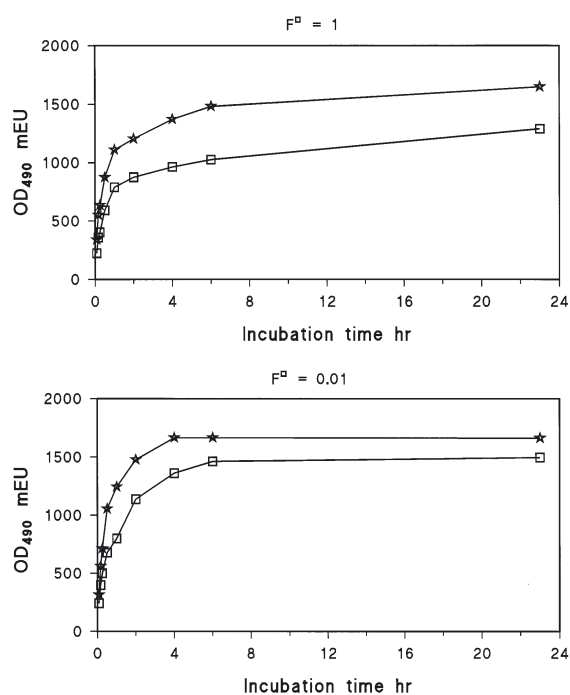
The liquid surface curvature was estimated considering  $150 \mu\text{L}$  liquid volume, at which the geometric heights are  $4.9$  and  $4.4 \text{ mm}$  for StarWell and F-well, respectively (Fig. 4). With a liquid surface curvature, the reading heights are lower than these geometric heights by a distance,  $d$ , determined by the  $OD^*/OD^{\square}_{det}$  value =  $1.138$ , calculated from #11 for  $V = 150 \mu\text{L}$ :  $(4.4-d)21.138 = 4.9-d$ , implying  $d \approx 0.8 \text{ mm}$ . By enclosing the corresponding volume difference,  $0.82\pi 23.35^2 \mu\text{L}$ , in a well-inscribed rotation body with a profile area,  $r^2X(1-\pi/4) \text{ mm}^2$  (Fig. 7), the curvature estimate resulted from the calculated radius,  $r \approx 2.5 \text{ mm}$ , in that profile. This leaves a plane reading area diameter of only  $1.8 \text{ mm}$ , giving occasion for a general consideration of the reading beam widths and center positions.

### StarWell Performance

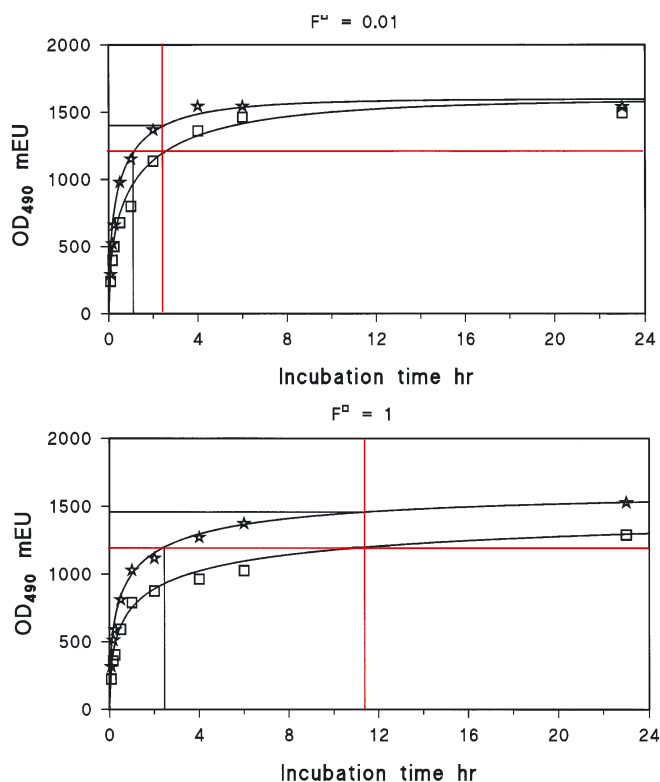
For simplicity, the demonstration of StarWell vs. F well performance was based on one-layer adsorption experiments.

StarWells (\*) and F-wells (□) of Thermo Scientific Nunc MaxiSorp surface quality (Cat. Nos. 441653 and 468667) were incubated for increasing times with  $150 \mu\text{L}/\text{well}$  of peroxidase conjugated IgG = IgG:HRP (Dako P 128),  $0.05 \mu\text{g}/\text{mL}$ , or  $1 \times \text{IgG:HRP} + 99 \times \text{IgG}$  (Dako Z 181),  $5 \mu\text{g}/\text{mL}$ , both in carbonate buffer, pH 9.6. After adsorption, the wells were washed three times with PBS containing an extra  $0.2 \text{ M NaCl}$  and  $0.05\%$  Triton X-100, pH 7.2. This was followed by substrate reaction with  $150 \mu\text{L}/\text{well}$  of  $\text{H}_2\text{O}_2/\text{OPD}$  in phosphate citrate buffer, pH 5.0, subsequently stopped with  $110 \mu\text{L}/\text{well}$  of  $2 \text{ N H}_2\text{SO}_4$ , resulting in  $260 \mu\text{L}$  reading volumes.

All reactions were performed at room temperature. The OD readings are presented in Fig. 8.



**Fig. 8**  
IgG adsorption kinetics data from incubation of MaxiSorp StarWell (\*) and MaxiSorp F-well (□) with 150  $\mu$ L/well of IgG solutions with concentrations corresponding to 1% F-well surface saturation, i.e.  $F^{\square} = 0.01$  (above), and to 100% F-well saturation, i.e.  $F^{\square} = 1$  (below). See text for further explanation.



**Fig. 9**  
Simulations of the data in Fig. 8 by the model ADEs (#14a,b) for  $F^{\square}$ ;  $F^* = 0.01$ ; 0.00667 (above), and for  $F^{\square}$ ;  $F^* = 1$ ; 0.667 (below). The model adsorption densities ( $E_i$ ) were converted to ODs by multiplication with the common maximum signal estimate of 1600 mEU, divided by the respective  $F$  values. The StarWell data were corrected for the liquid height elevations according to #11 for 260  $\mu$ L reading volumes. As an example, the levels of 75% adsorption of supplied molecules (red horizontal lines) were used for comparison of the StarWell vs. F-well performance. Between the line of equal adsorption percentage (75%) and equal incubation time (red vertical line) in each diagram, the respective StarWell curves exhibit regimes, demarcated by the black lines, where both time reduction and adsorption increase can be obtained. Note that the StarWell adsorption acceleration is much larger at the high molecular supplies than at the low supplies. See text and Figs. 10 and 11 for further explanation.

According to the estimated MaxiSorp™ IgG adsorption capacity of 650 ng/cm<sup>2</sup> <sup>3</sup>, the IgG concentrations utilized correspond to 1% and 100% F-well surface saturation, i.e.  $F^{\square} = 0.01$  and 1, respectively. Using 150  $\mu$ L reagent volumes, the corresponding StarWell values are  $F^* = 0.00667$  and 0.667, respectively, since the StarWell surface increase factor is 1.50 (Table 1). [F generally denotes the ratio between the number of supplied molecules and the number of molecules that the surface can adsorb - not to be confused with the designation “F-well” for the standard, flat-bottom MicroWell.] Further, the F-well and StarWell surface/volume ratios are  $P^{\square} = 8.3 \text{ cm}^{-1} \cdot \text{L}^{-1}$  and  $P^* = 8.3215 \text{ cm}^{-1} \cdot \text{L}^{-1}$ , respectively.

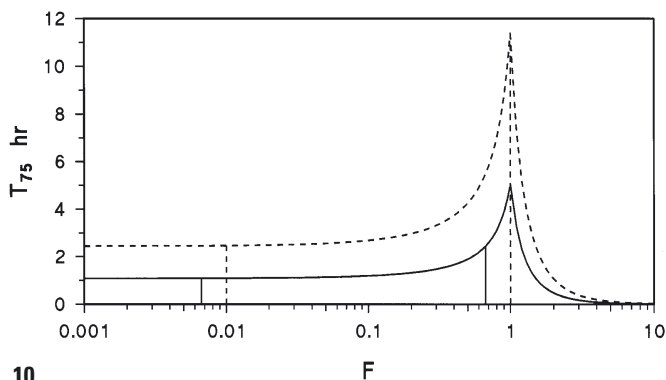
To match the StarWell readings with the F-well readings for a comparative adsorption analysis, the StarWell readings were corrected for the elevated liquid heights by division with the  $OD^*/OD^{\square}_{det}$  value = 1.08, calculated from #11 for  $V = 260 \mu\text{L}$ .

The corrected readings were simulated in Fig. 9 by the model Adsorption Density Equations (ADE), #14a,b in Appendix, showing correlation between real and theoretical adsorption kinetics.

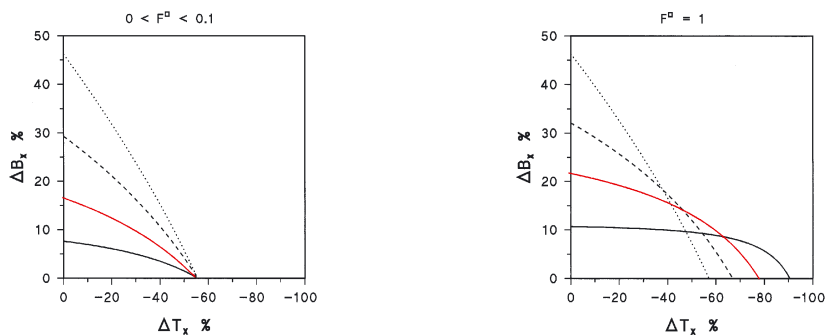
As an example, the levels of 75% adsorption of supplied molecules were used for further comparison of the StarWell vs. F-well adsorption performance (Fig. 9).

In Fig. 10, the model Adsorption Time Equations (ATE), #15a,b,c in Appendix, were depicted for 75% adsorption of the supplied molecules with StarWell and with F-well, respectively. The graphs illustrate the time reductions obtainable by utilization of StarWell instead of F-well in accordance with the interpolations in Fig. 9.

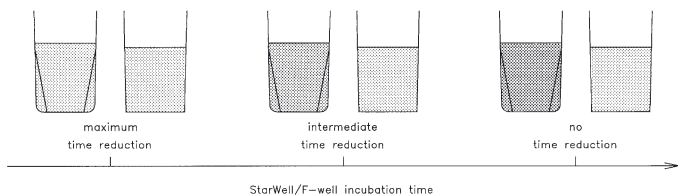
At concentrations corresponding to  $\leq 1/10$  F-well surface saturation, i.e.  $0 < F^{\square} \leq 0.1$ , the time reduction is almost constant by a factor equal to the



**Fig. 10**  
Graphic presentation of the model ATEs (#15a,b,c) for 75% adsorption of the supplied molecules (Fig. 9), i.e. the 75% adsorption time ( $T_{75}$ ) vs. the ratio ( $F$ ) between the number of supplied molecules and the number of molecules that the surface can adsorb, for StarWell (—), and for F-well (---). For  $F^* = F^\square$  (implying different StarWell and F-well concentrations of supplied molecules), the  $T_{75}^\square/T_{75}^*$  ratio is constant =  $1.50^2 = 2.25$  in the whole  $F$  regime,  $0 < F < \infty$ . For equal concentrations (implying  $F^* = 0.667 \times F^\square$ ), the  $T_{75}^\square/T_{75}^*$  ratio is approximately constant  $\approx 2.3$  for  $0 < F^\square \leq 0.1$ , and increasingly larger for  $0.1 < F^\square \leq 1$  with a maximum = 4.7 (calculated from #15a,b) for  $F^\square = 1$ . The solid and dashed vertical lines represent, respectively, the  $T_{75}^*$  and  $T_{75}^\square$  times for the actual  $F$  values. Note that these times are, respectively, the same as the interpolated times in Fig. 9. See text for further explanation.



**Fig. 11**  
Graphic presentation of the model AIEs (#16a,b), i.e. StarWell to F-well adsorption increment ( $\Delta B_x$ ) vs. time reduction ( $\Delta T_x$ ), corresponding to the data simulations in Fig. 9, for F-well adsorption percentages,  $x = 10\%$  (···),  $50\%$  (---),  $75\%$  (---) and  $90\%$  (----). For  $0 < F^\square \leq 0.1$  (above),  $\Delta B_x$  increases with decreasing  $x$ , whereas  $\Delta T_x$  is approximately constant for any  $x$ . For  $F^\square = 1$  (below),  $\Delta B_x$  increases further with decreasing  $x$ , and  $\Delta T_x$  now increases with increasing  $x$ . For  $0.1 < F^\square < 1$ , there will be a gradual transition from the upper to the lower diagram curves. Note that between the extremes of maximum  $\Delta T_x$  (for  $\Delta B_x = 0$ ) and maximum  $\Delta B_x$  (for  $\Delta T_x = 0$ ), intermediate  $\Delta T_x$  and  $\Delta B_x$  can be obtained.



**Fig. 12**  
Summarizing illustration, for 250  $\mu\text{L}$  reading volume, of the advantages with StarWell, in relation to F-well incubated for less than the time required to immobilize “all” the supplied molecules (for  $F^\square \leq 1$ ). At “maximum” incubation time reduction with StarWell, i.e. the reduction determined by the surface to volume ratio increase, the same amount of molecules will be immobilized, resulting in the same concentration of signal molecules, in both wells (left). At no time reduction with StarWell, a “maximum” immobilization enhancement will occur, resulting in a larger concentration of signal molecules (right). At an intermediate time reduction, an intermediate immobilization enhancement will occur, resulting in an intermediate concentration of signal molecules (middle). Note that the reading column height enlargement with StarWell will add to the OD reading in any case.

square of the surface to volume ratio increase. The constancy is due to the fact that in this  $F$  regime plenty of unoccupied sites remain available on the surfaces.

At higher concentrations, the time reduction is increasingly larger with a maximum at the concentration just matching the F-well surface saturation, i.e.  $F^\square = 1$ . This can be explained by considering that it will take additional time for the last molecules to find the last unoccupied spaces on the surface.

At still higher concentrations, i.e.  $F^\square > 1$ , the situation is eventually reversed. That is, more time is required with StarWell than with F-well to adsorb e.g. 75% of the supplied molecules. However, in this  $F$  regime adsorption times become very short in any case.

In Fig. 11, the model StarWell to F-well Adsorption Increment Equations (AIE), #16a,b in Appendix, expressing the adsorption increment as a function of the time reduction, were depicted for various F-well adsorption percentages. The graphs illustrate that the StarWell adsorption increment increases with decreasing F-well adsorption percentage and with increasing  $F^\square$ , in accordance with the ADE curves in Fig. 9.

**Performance Discussion**

The StarWell to F-well performance relationship holds for immobilization of any reactant in a solid phase bioassay sequence <sup>1</sup>, because, when other things are equal, it results purely from the larger StarWell probability that a molecule will hit the surface due to the larger surface to volume ratio (i.e. the liquid is exposed to more surface).

The primary performance aspect of StarWell is incubation time saving. This can be converted to an immobilization increase by renouncing all, or part of, the possible time reduction, as illustrated in Fig. 11. Therefore, some increase of sensitivity could be gained within a finite incubation time.

However, using enough incubation time, virtually all (scarce) analyte molecules in a certain liquid volume will eventually be immobilized in both wells, since there will normally be ample binding sites present on both well surfaces. This can be illustrated by the analyzed system, regarding the IgG as the analyte to be “captured” by the adsorbing surface sites.

For concentrations corresponding to, for example,  $F^{\square} \leq 0.01$ , the F-well incubation time required to obtain 99% adsorption is almost constant  $\approx 6$  hr, calculated from #15a (Appendix) for  $F^{\square} = 0$ . Thus, using this incubation time, practically no additional adsorption will be obtained with StarWell; however, the same adsorption could have been obtained in about half the time, i.e.  $\approx 3$  hr.

A true sensitivity increase can be obtained with StarWell only when the analyte binding molecules are so poor that they are a limiting factor to analyte immobilization. Such poor binding characteristics could be observed in any solid phase system.

It should be noted that a prerequisite for maintenance of the StarWell effects on a second layer analyte immobilization is that the surface coating densities in StarWell and F-well are equal, implying a proportionally higher StarWell coating concentration. Thus, it can be derived from the model <sup>1</sup> that the analyte immobilization times will just balance by using the same coating concentration ( $\leq$  the F-well saturating concentration) in both wells, implying a proportionally lower StarWell coating density.

If a certain sub-saturating coating density is desirable for some reason (cf. the following article), rather than a saturating density, an inherent delay of analyte immobilization could be remedied, to some extent at least, by using StarWell instead of F-well.

In addition to faster immobilization of liquid phase molecules, the vertical MicroWell reading configuration results in larger OD readings in StarWell than in F-well. This is due to the fins' elevation of liquid heights (cf. StarWell Geometry). If, for instance, the height dependent StarWell to F-well OD increment

is 10%, there will, for this reason alone, be 10% more distance between the signal and the background readings with StarWell. This effect would obviously be the more pronounced as the reading volume is reduced (Table 1).

The advantages of StarWell compared to F-well, comprising immobilization time reduction, immobilization enhancement, and reading column height enlargement, are summarized qualitatively in Fig. 12.

## References

- Esser P. (1992).  
The surface/volume ratio in solid phase assays.  
Thermo Scientific Nunc Bulletin No. 10, 3-6.
- Esser P. (1985).  
Adsorption geometry in Nunc products for solid phase assays.  
Thermo Scientific Nunc Bulletin No. 1, 3-4.
- Esser P. (1988).  
Principles in adsorption to polystyrene.  
Thermo Scientific Nunc Bulletin No. 6, 1-5.

## Appendix

The adsorption kinetics model <sup>1</sup> originates in a combination of diffusion kinetics with the kinetics for a second order chemical reaction (A+C ⇌ B), regarding the adsorbing surface sites as one reactant (A), the liquid phase molecules as the other reactant (C), and the bound molecules as the reaction product (B), to form the Adsorption Rate Equation (ARE), (cf. symbol legend below):

$$dB_t/dt = [(A-B_t)/A] \cdot [(C-B_t)/V] \cdot S \cdot (k \cdot D/\pi)^{1/2} \cdot t^{-1/2} \quad \#13$$

which by integration gives the Adsorption Density Equations (ADE), expressing the fraction,  $E_t$ , of the surface adsorption capacity adsorbed at time  $t$ :

$$E_t\{F \neq 1\} = \frac{B_t}{A} = \frac{1 - \exp\{(F-1) \cdot P \cdot (4 \cdot k \cdot D/\pi)^{1/2} \cdot t^{1/2}\}}{1/F - \exp\{(F-1) \cdot P \cdot (4 \cdot k \cdot D/\pi)^{1/2} \cdot t^{1/2}\}} \rightarrow \begin{cases} F \text{ for } F < 1 \\ 1 \text{ for } F > 1 \end{cases} \quad \#14a$$

$$E_t\{F=1\} = P \cdot (4 \cdot k \cdot D/\pi)^{1/2} \cdot t^{1/2} / [P \cdot (4 \cdot k \cdot D/\pi)^{1/2} \cdot t^{1/2}] \rightarrow 1 \quad \#14b$$

From equations #14a,b, one can derive the Adsorption Time Equations (ATE), expressing the time,  $T_x$ , required to adsorb  $x\%$  of the supplied molecules (for  $F \leq 1$ ), or  $x\%$  of the surface adsorption capacity (for  $F > 1$ ):

$$T_x\{F < 1\} = P^2 \cdot (4 \cdot k \cdot D/\pi)^{-1} \cdot (1-F)^{-2} \cdot [\ln\{(100-x \cdot F)/(100-x)\}]^2 \text{ hr} \quad \#15a$$

#15b

$$T_x\{F > 1\} = P^2 \cdot (4 \cdot k \cdot D/\pi)^{-1} \cdot (1-F)^{-2} \cdot [\ln\{(100-x/F)/(100-x)\}]^2 \text{ hr} \quad \#15c$$

From equations #15a, b, one can derive the Adsorption Increment Equations (AIE), expressing e.g. the StarWell to F-well adsorption increment,  $\Delta B_x$ , when the F-well adsorption is  $x\%$  of the supplied molecules:

$$\Delta B_x\{F^\square < 1\} = [100 \cdot \frac{1 - \{(100-x \cdot F^\square)/(100-x)\} \cdot \{(1 - |\Delta T_x|/100)^{1/2} \cdot (p - F^\square)/(1 - F^\square)\}}{F^\square - \{(100-x \cdot F^\square)/(100-x)\} \cdot \{(1 - |\Delta T_x|/100)^{1/2} \cdot (p - F^\square)/(1 - F^\square)\}} - x] \cdot 100/x \% \quad \#16a$$

$$\Delta B_x\{F^\square = 1\} = [100 \cdot \frac{1 - \exp\{(1 - |\Delta T_x|/100)^{1/2} \cdot (p-1) \cdot x / (100-x)\}}{1/p - \exp\{(1 - |\Delta T_x|/100)^{1/2} \cdot (p-1) \cdot x / (100-x)\}} - x] \cdot 100/x \% \quad \#16b$$

The used symbols translate as follows:

A = number of molecules that the surface can adsorb

$B_t$  = number of molecules adsorbed at time  $t$

$\Delta B$  = StarWell to F-well adsorption increment = %

C = number of supplied molecules

D = diffusion constant of IgG =  $1.44 \cdot 10^{-3} \text{ cm}^2 \cdot \text{hr}^{-1}$

$E_t$  = fraction of A adsorbed at time  $t$

F = C/A

$F^\square$  = F-well F value

k = dimensionless coefficient =  $2\pi$

P =  $S/V = \text{cm}^{-1}$

p =  $P^*/P^\square$

S = liquid covered surface area =  $\text{cm}^2$

t = elapsed adsorption time = hr

$\Delta T$  = StarWell to F-well adsorption time reduction = %

V = liquid volume =  $\text{cm}^3$

[www.thermoscientific.com/oemdiagnostics](http://www.thermoscientific.com/oemdiagnostics)

© 2010 Thermo Fisher Scientific Inc. All rights reserved. "Dako" is a registered trademark of Dako Denmark A/S, and "Triton" is a registered trademark of Dow Chemical Company. All other trademarks are the property of Thermo Fisher Scientific Inc. and its subsidiaries.

# Comparison of Affinity-Isolated and Non-Isolated Antibodies Used as Capture Antibodies in ELISA

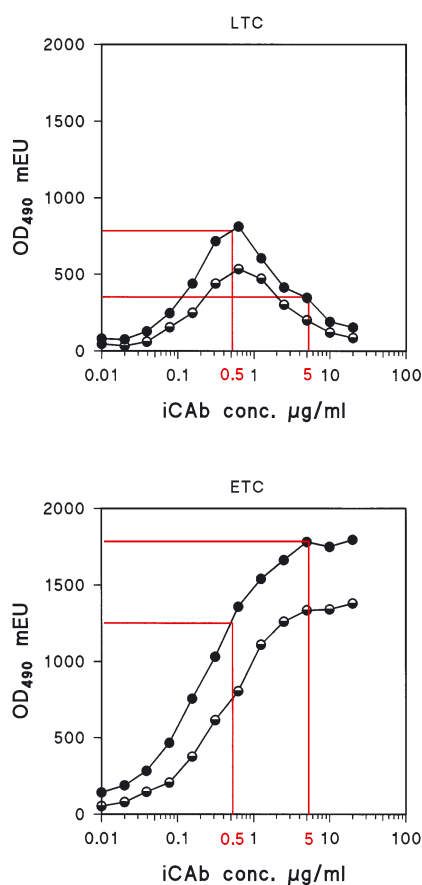
In Thermo Scientific Nunc Bulletin No. 11<sup>1</sup> it was discussed that the higher ELISA sensitivity found with a non-saturated capture antibody (CAb) surface compared to a saturated CAb surface, using affinity isolated, polyclonal CAb, might be due to a density dependent difference in the detection molecules' access to the analyte (target) molecules.

Recent findings from the comparison of non-isolated CAb and affinity isolated CAb suggest that this phenomenon is due to steric hindrance of the CAb at high surface densities.

In addition, this work proposes that the affinity isolated CAb is more sensitive to density dependent steric hindrance than the non-isolated CAb.

## Materials & Methods

Thermo Scientific Nunc Immuno Plates F96 MaxiSorp (Cat. No. 439454) were coated overnight with a 1:2 dilution series of affinity isolated, polyclonal swine anti-rabbit (SaR) capture IgG antibodies = iCAb (Dako Z 400) in PBS, pH 7.2. Coating was followed by overnight incubation with rabbit target IgG antibodies = TAb (Dako A 008) in PBS with 0.05% Tween 20, in concentrations of either 20 ng/mL (low TAb concentration, LTC), or 10 µg/mL (excess TAb concentration, ETC). The captured target antibodies were detected by a 1 hour incubation with an excess of either SaR peroxidase conjugate (Dako P 217), or 1 part conjugate attenuated with 2 parts SaR (Dako Z 196), in PBS with 0.05% Tween 20, and subsequent substrate reaction with H<sub>2</sub>O<sub>2</sub>/OPD in phosphate citrate buffer, pH 5.0, stopped with 2N H<sub>2</sub>SO<sub>4</sub>,



**Fig. 1**

Signals of captured target antibodies (TAB) in MaxiSorp F-wells coated with increasing concentrations of affinity isolated capture antibodies (iCAb), at low TAB concentration, LTC (above), or at excess TAB concentration, ETC (below), using unattenuated (●), or attenuated (◐) conjugate. The OD values represent the total readings minus the respective background readings from wells without target molecules.

The red line interpolations correspond to the conditions in the previous work<sup>1</sup>, using 1/10 saturating (0.5 µg/mL) and 1/1 saturating (5 µg/mL) iCAb concentrations, and unattenuated conjugate. Note that the LTC signals are higher in an interval of non-saturating iCAb concentrations than at saturating concentrations, and that the results are, qualitatively, independent of conjugate attenuation. See text for further explanation.

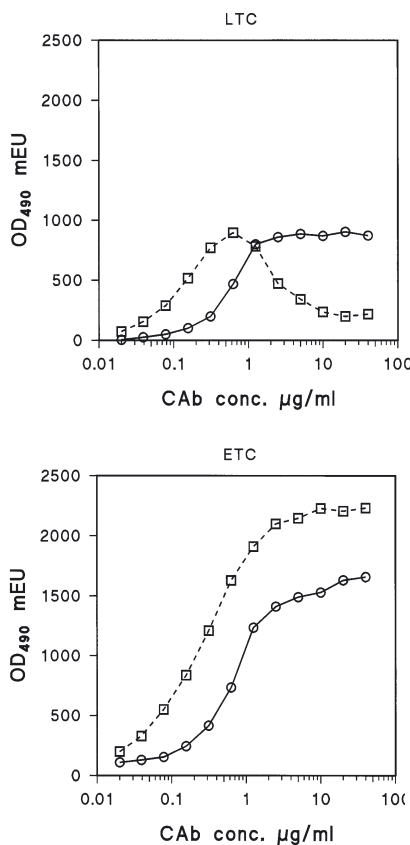
150 µL/well. All other reaction volumes were 200 µL/well. The Dako reagents used here and in the previous investigation<sup>1</sup> were from the same supplied ampoules. Between the reaction steps, the wells were washed three times with PBS containing an extra 0.2 M NaCl and 0.05% Triton X-100. All reactions were performed at room temperature. Unspecific adsorption of target or detection molecules was diminished by the overall use of detergent<sup>2</sup>. The results are presented in Fig. 1.

For proper comparison of affinity isolated (iCAb) and non-isolated (nCAb) capture antibodies, the above experiment was repeated (with unattenuated conjugate only) using, in parallel, iCAb and nCAb from the same SaR serum preparation (that is corresponding lots of Dako Z 400 and Z 196, respectively, obtained by courtesy of Dr. P. Kaastrup, Dako). The results are presented in Fig. 2.

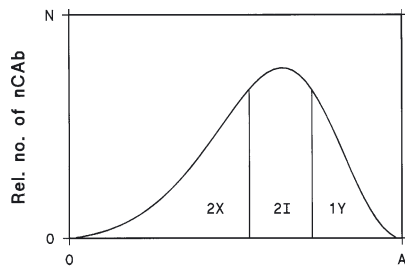
## Results

The results in Fig. 1 show that for the low TAB concentration (LTC), an “internal” maximum signal is obtained at an iCAb coating concentration close to 0.5 µg/mL, corresponding to 1/10 surface saturation in the Nunc<sup>™</sup> MaxiSorp<sup>™</sup> F-well using 200 µL coating liquid<sup>1</sup>. This is not the case for the excess TAB concentration (ETC), where a “terminal” maximum signal plateau is obtained at saturating iCAb coating concentrations, i.e. 5 µg/mL and above. These findings are seen to be independent of conjugate attenuation.

The results in Fig. 2 show that for the LTC, the nCAb curve does not share the peculiar signal peak



**Fig. 2**  
Signals of captured target antibodies (TAB) in MaxiSorp F-wells coated with increasing concentrations of affinity isolated capture antibodies, iCAB (□ - - □), or non-isolated capture antibodies, nCAB (○ - - ○), at low TAB concentration, LTC (above), or at excess TAB concentration, ETC (below), using unattenuated conjugate. The OD values are the total minus background means from three independent experiments. Note that the LTC maximum signal occurrence at a non-saturating CAb concentration is a phenomenon connected with iCAB only. See Fig. 1 and text for further explanation.



**Fig. 3**  
Empirical model of the target affinity profile of the nCAB preparation used, assuming a 1Y:2I:2X relationship between the numbers of IgG antibodies having high affinity (Y), medium affinity (I), and low or no affinity (X). The iCAB preparation is assumed to consist of I-antibodies only.

with the iCAB curve. Rather it climbs to a terminal maximum signal plateau, like both curves do for the ETC.

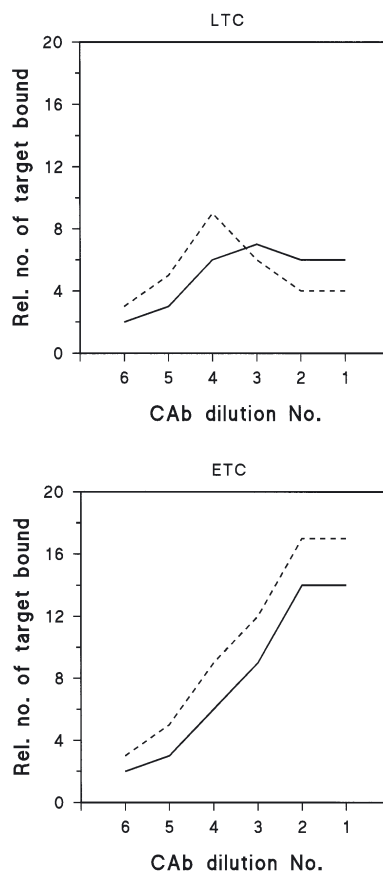
**Discussion**

In Fig. 1, the qualitatively identical pictures with both conjugate reagents (see Materials & Methods) suggest that the results are free from possible substrate reaction inconsistencies. The common leveling-off of the ETC curves at an iCAB coating concentration of 5 µg/mL suggests that the MaxiSorp surface area utilized is just saturated at this concentration, consistent with the estimated MaxiSorp IgG binding capacity of 650 ng/cm<sup>2</sup> 1,3.

In Fig. 2, similar nCAB and iCAB performance pictures would have been expected, not only for the ETC, but also for the LTC, according to the previous explanation of the internal LTC maximum signal ref. 1. This explanation states that the detection (conjugate) molecules have a better access to the target molecules on a non-saturated CAb surface than on a saturated surface due to the spaced CAb molecules on the non-saturated surface. In that case, the lack of a corresponding internal ETC maximum signal could be explained by assuming that the poorer conjugate access with increasing CAb density is compensated by capture of more TAB.

An alternative explanation of the observed internal LTC maximum signal by density dependent steric hindrance of the CAb did not seem to fit with the lack of an internal ETC maximum signal. Likewise, even though a higher active percentage of CAb molecules was estimated to be present on the non-saturated surface, the real number of active molecules remained higher on the saturated surface 1.

The present results, demonstrating different iCAB and nCAB performances for the LTC, suggest that the phenomenon



**Fig. 5**  
Graphic presentation of the numbers of firmly bound target molecules from the model surface scenarios in Fig. 4, for increasing densities of iCAB (---), or nCAB (—), at low target concentration (above), or at excess target concentration (below). Note the qualitative resemblance between these model curves and the data curves in Fig. 2.

may in fact be related to density dependent first layer CAb activity, dependent on the CAb character, rather than to density dependent conjugate abundance. Therefore, the explanation by steric hindrance was reconsidered - under the following assumptions (Figs. 3 and 4):

1. The nCAB preparation consists of three types of IgG antibodies, one having high target affinity (Y), another having medium affinity (I), and a third having low or no affinity (X).
2. The iCAB preparation consists primarily of I-antibodies from the nCAB preparation. This seems plausible since most of the X-antibodies may have passed unhindered through the affinity isolation column during application of the nCAB





and been discarded with the primary eluate, whereas most of the Y-antibodies may not have been eluted under the necessarily gentle, non-denaturing conditions.

3. I- and X-antibodies are more sensitive to density dependent steric hindrance than Y-antibodies. The idea is that steric hindrance is a graduated phenomenon: the higher the antibody's affinity is, the less impaired is its target binding strength by neighboring molecules.
4. The more sterically hindered anti-bodies will compete with the less hindered antibodies for capture of target molecules, but the more hindered antibodies will tend to lose the target molecules by subsequent washing.

The validity of these assumptions is demonstrated by the simplified approach outlined in Figs. 3 and 4, since the resulting model curves in Fig. 5 have the essential characteristics in common with the data curves in Fig. 2.

### Summary

This investigation demonstrated that, when used as first layer capture antibodies in ELISA, affinity isolated polyclonal antibodies (iCAb) present maximum assay sensitivity at an iCAb density close to 1/10 surface saturation. Non-isolated antibodies (nCAb) present maximum sensitivity (of the same magnitude) at the nCAb density equalling surface saturation. This was explained by density dependent steric hindrance, to which iCAb was assumed to be more sensitive than nCAb.

However, it was necessary to make additional, supporting assumptions. The most essential (and controversial) support assumption states that the more sterically hindered antibodies "i" will compete with the less hindered antibodies for capture of target molecules, and that some, preferably i-bound target molecules will be detached by subsequent washing.

The difference between the iCAb and nCAb performances should be considered in assay construction. Probably, when using nCAb, a surface saturating coating would be optimal, whereas, when using iCAb, a non-saturating

coating would be optimal. The particular optimum iCAb density should be determined a priori by adjusting the coating concentration to obtain maximum signal for an appropriately low concentration of target molecules.

In conclusion, the iCAb application presents the advantages of coating antibody uniformity and economy. However, it also has the disadvantages of only moderate antibody affinity and possible adsorptive denaturation in the absence of space-filling support molecules <sup>1</sup>.

The interesting question of how monoclonal antibodies would perform as immobilized capture antibodies in comparison with the polyclonal iCAb and nCAb remains to be addressed.

### References

1. Esser P. (1993).  
Activity of adsorbed antibodies.  
Thermo Scientific Nunc Bulletin No. 11, 3-6.
2. Esser P. (1990).  
Detergent in polystyrene ELISA  
Thermo Scientific Nunc Bulletin No. 8, 1-6.
3. Esser P. (1988).  
Principles in adsorption to polystyrene.  
Thermo Scientific Nunc Bulletin No. 6, 1-5.

# Stability of Thermo Scientific Nunc Immuno MaxiSorp Surfaces

*Svend Erik Rasmussen, M.Sc., Senior Scientist, Thermo Fisher Scientific*

Thermo Scientific Nunc Immuno MaxiSorp products are the result of extensive research in order to produce surfaces with a high and uniform immunoglobulin binding capacity.

However, the elaborate adsorption qualities of Nunc™ MaxiSorp™ surfaces may change if the product is handled incorrectly, e.g. by exposure to UV light or high temperatures.

This report describes the temperature influence on Nunc Immuno™ MaxiSorp products stored for various periods of time.

## Materials and Methods

Immuno Plates MaxiSorp F96 from one batch were used in all experiments, except in the batch to batch variation analysis. After exposing the plates to different temperatures for various periods of time, the surface stability was tested using the binding uniformity test (described in Thermo Scientific Nunc Bulletin No. 4). In short, a mixture of enzyme-conjugated and unconjugated antibodies in carbonate buffer, pH 9.6, was added to each well (200 µL/well). After incubation overnight, each well was washed 3 times with PBS containing 0.05% Triton X-100.

Color development by substrate reaction was read on an Immuno Reader NJ 2000. The mean, standard deviation, and CV were calculated using in-house software on an IBM-AT computer.

Storage at the following temperatures was used to simulate various storage/transport conditions: +60°C, +37°C, +4°C, room temperature (+20°C), -70°C, and outdoor temperature variations.

## Results

Plates produced in a five year period were compared in order to make sure that storage at room temperature did not change the binding properties of the MaxiSorp surfaces. The results from this batch to batch comparison are shown in Fig. 1. Seven different batches were tested, and only a slight variation in the binding capacity was observed.

This means that under standard storage conditions at room temperature, MaxiSorp products can be kept in stock for at least 4 years without affecting the surface binding capacity.

All other results are expressed as a percentage of values obtained simultaneously from plates kept at room temperature.

Transport during winter in cold climates may lead to exposure to extremely low temperatures for short periods of time, e.g. during air transport. In Fig. 2 are shown the results of plates stored at -70°C. Plates were stored for up to one month, and as indicated in the figure, no significant change occurred when compared with plates stored at room temperature.

In hot climates the products may be exposed to temperatures well above +40°C for short or long time periods. The effect of exposure to high temperatures was demonstrated by storing plates at +60°C (results are shown in Fig. 2). The signal level decreased by 30% after three days of storage, but remained thereafter constant for the rest of the observation period (42 days).

Plates stored at room temperature, +4°C, +37°C, and plates stored outdoor (packed in

a plastic bag) were followed for more than one year. The results are shown in Fig. 3.

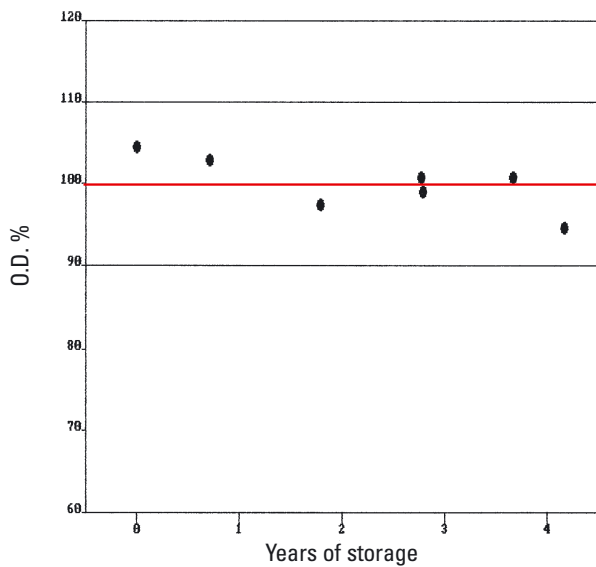
There was no significant difference between the results obtained for plates stored at +4°C, at room temperature, or outdoor. However, after being stored at +37°C for 150 days, the plates showed a 10% decrease in signal as compared to those stored at room temperature. But after this period no further decrease could be observed for up to one year of storage.

## Conclusion

From these experiments it can be concluded that Immuno MaxiSorp surfaces can be stored for at least one year at temperatures below +37°C without changing their high adsorption properties. Storage at +37°C will reduce the signal level by 10% during the first 150 days, but after that no further decrease can be observed.

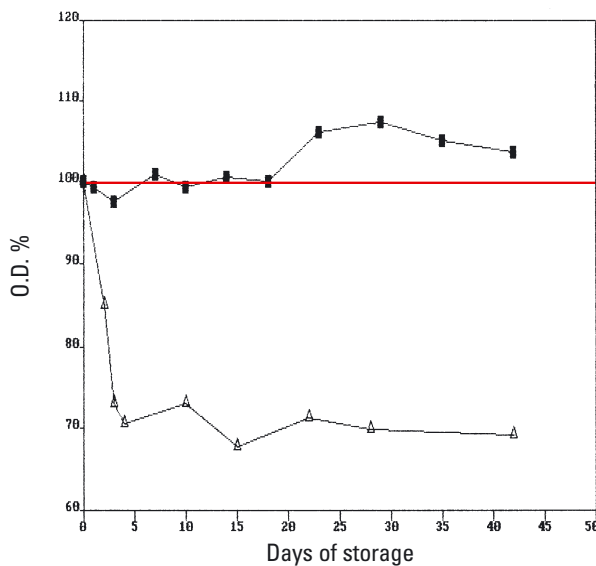
Storage at high temperatures, even for short periods, should be avoided as the signal level decreases rapidly at +60°C. However, like plates stored at +37°C, the decrease in signal level will not continue, but will stop at a temperature specific level. For plates stored at +60°C, the signal level decreases to 70% of the value for plates stored at room temperature.

It should be noted that these studies were performed exclusively with IgG. The adsorption of other molecules might respond differently to storage temperature.



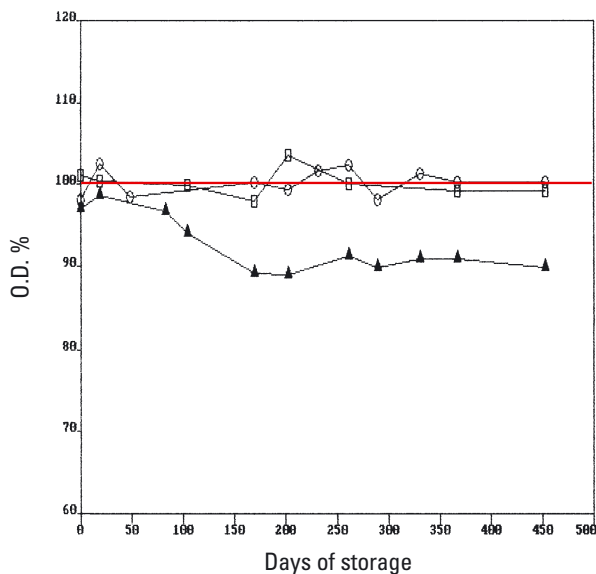
**Fig. 1**

Simultaneous adsorption performances of individual plate batches (●) produced fin a 5 year period and stored under standard conditions at room temperature. The values are given in percent of their common mean (red line). Note that the values stay between +/-5% from the mean during storage for more than 4 years.



**Fig. 2**

Adsorption by plates stored at -70°C (△) and at +60°C (■) in percent of adsorption by plates kept at room temperature (red line). Whereas cold storage implies no change, storage at +60°C quickly reduces adsorption to a constant level at about 70% of the initial value.



**Fig. 3**

Adsorption by plates stored at +4°C (□), outdoor (V), and at +37°C (▲) in percent of adsorption by plates kept at room temperature (red line). Whereas storage at +4°C or outdoors implies no change, storage at +37°C slowly reduces adsorption to a constant level at about 90% of the initial value.

[www.thermoscientific.com/oemdiagnostics](http://www.thermoscientific.com/oemdiagnostics)

© 2010 Thermo Fisher Scientific Inc. All rights reserved. "Triton" is a registered trademark of Dow Chemical Company. All other trademarks are the property of Thermo Fisher Scientific Inc. and its subsidiaries.

# Thermo Scientific Nunc FluoroNunc Modules and Plates

## - The principle behind Q.C. procedure

In order to obtain reliable results from assays based on fluorescence detection, it is of utmost importance to have a low uniform background fluorescence from the reaction vessel, as well as the highest possible positive signal. The Thermo Scientific Nunc FluoroNunc products have been developed to fulfil these requirements.

The Nunc™ FluoroNunc™ product group consists of plates and modules in transparent, white or black surface types, each type matching the different needs required by the different techniques. Transparent plates are intended for use in applications where the lowest background fluorescence is needed and a “read-through” detection system is used, e.g. in some time resolved fluorescence instruments.

White plates give the highest possible reflection of the fluorescent signal with a low background fluorescence. These plates are superb for most applications where the type of reading used is epifluorescence. Black plates give the lowest possible background fluorescence, minimizing the backscatter light generated by using epifluorescence. For read through instruments black or white plates are available with optically clear bottoms.

### Materials

The antibodies were from DAKO (Denmark), and 0.05 M carbonate buffer pH 9.6 was used as coating buffer.

Antibody mixture: Rabbit anti-sheep (1:5000) and peroxidase conjugated rabbit anti-human AFP (1:40.000).

PBS (pH 7.2, 0.5 M) + 0.05% Triton X-100 + 0.2 M NaCl (PBS Wash) was used for washing.

3-(p-HydroxyPhenyl) Propionic Acid (HPPA) 20 mm in 0.1 M Tris-HCl pH 8.5 + 0.036% H<sub>2</sub>O<sub>2</sub> was used as fluorescent substrate. Reagents were from Sigma unless otherwise stated.

### Test method

The test principle is based on the competition between labeled and unlabeled antibodies for binding sites on the surface. The concentration of antibody is fixed at 4 µg/mL (surface saturation conditions). The concentration of labeled antibody is adjusted in order to detect a reasonable signal after substrate reaction. The same procedure is used for all FluoroNunc products.

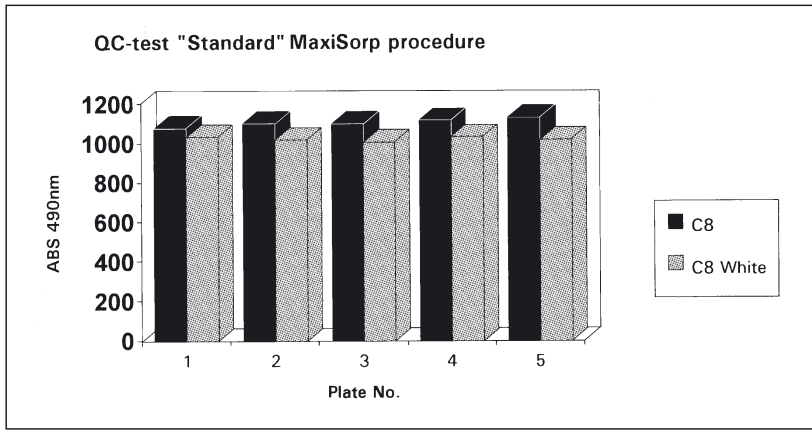
The plates are coated (150 µL antibody mixture/well) overnight at RT, covered and placed in the dark, then washed three times using PBS Wash followed by a substrate reaction, 150 µL/well. The reaction is stopped by adding 50 µL/well 1 N NaOH. The results are read in a fluorescence reader, i.e. Fluoroscan II.

In order to assure compatibility with the existing Thermo Scientific Nunc MaxiSorp product, we have made a non-fluorescent QC control test similar to the one used for FluoroNunc MaxiSorp™ certification. This test is based on

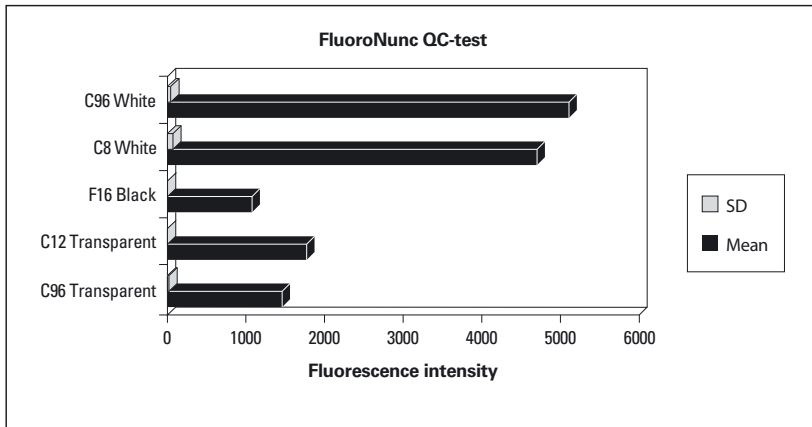
the same principle as indicated above except for using peroxidase/OPD as substrate/chromogen (see Thermo Scientific Nunc Bulletin No. 4, Aspects of Thermo Scientific Nunc MaxiSorp MicroWell Certification, for more details).

### Results

Comparison of standard MaxiSorp Plates (Fig. 1) and FluoroNunc plates (Fig. 2) using the standard MaxiSorp non-fluorescence method. Five plates were tested, and the mean and SD of each plate (96 wells) calculated. As can be seen from Fig. 1, similar results are obtained for the two products, i.e. the surface quality of FluoroNunc MaxiSorp is comparable to the standard MaxiSorp surface quality for antibody adsorption.



**Fig. 1.**  
 QC-test "Standard" MaxiSorp procedure  
 Five frames of standard Immuno Module C8, MaxiSorp (Transparent) were compared to five frames of FluoroNunc Immuno Module, White C8, MaxiSorp. The converted substrate/OPD were, for all plates, transferred to wells of Immuno Plate F96 for reading in Immuno reader NJ-2000. Each bar indicates mean value for each plate.



**Fig. 2.**  
 QC-test "Fluorescence" procedure  
 FluoroNunc Immuno Modules and Plates: White C8, MaxiSorp; White C96, MaxiSorp; Transparent C96, MaxiSorp; Transparent C12, MaxiSorp and Black F16, MaxiSorp, five plates of each, were compared using the Fluorescence procedure. The bars represent the mean and SD values for each product type.

[www.thermoscientific.com/oemdiagnostics](http://www.thermoscientific.com/oemdiagnostics)

© 2010 Thermo Fisher Scientific Inc. All rights reserved. "Dako" is a registered trademark of Dako Denmark A/S; and "Triton" is a registered trademark of Dow Chemical Company. All other trademarks are the property of Thermo Fisher Scientific Inc. and its subsidiaries.

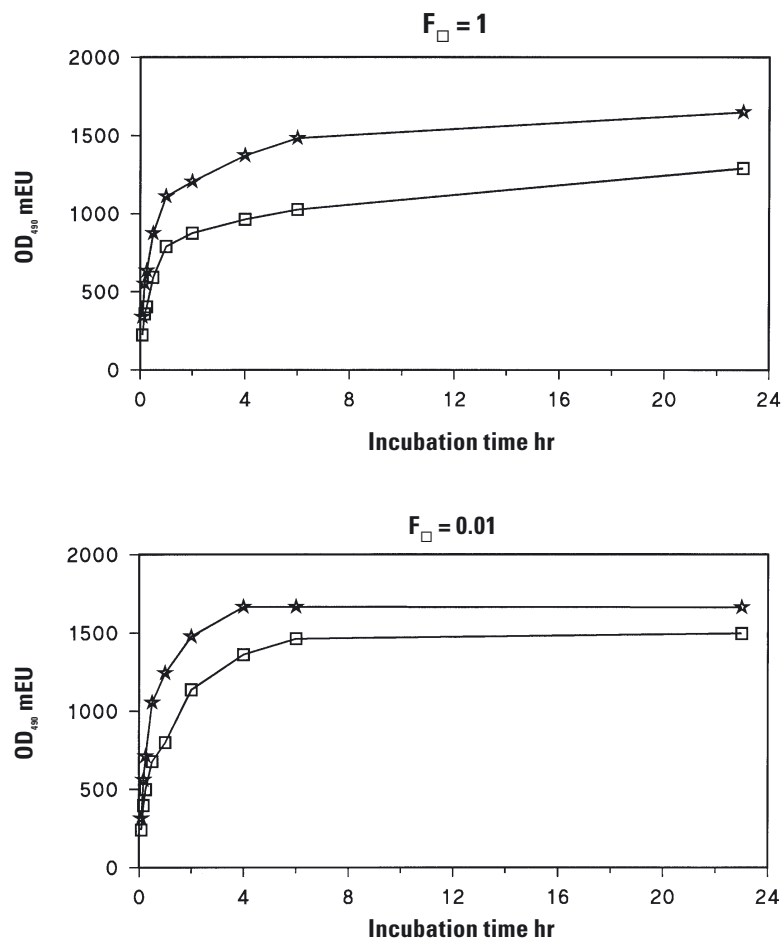
# Performance of Thermo Scientific Nunc Immuno C8 StarWell

The Thermo Scientific Nunc Immuno Module C8 StarWell, MaxiSorp or PolySorp surfaces, consists of MicroWells containing eight inner fins. As a result, the surface area is increased by a factor of approximately 1.5 when compared to standard, flat-bottom F-wells using reactant volumes ranging from 50 to 200  $\mu\text{L}$ .

In a solid phase assay, e.g. ELISA, a larger surface/volume ratio implies a faster adsorption of molecules from the liquid phase. Thus, the primary advantage of a larger surface/volume ratio is that assay time can be reduced.

Nunc™ StarWell™ incubation times may be reduced by a factor of approximately 2.25. According to adsorption kinetics modelling<sup>1</sup>, incubation times can be reduced by a factor equal to the square of the surface/volume increase factor, without reducing adsorption.

This Tech Note demonstrates StarWell vs. standard F-well performances for first layer, passive IgG adsorption according to the model<sup>1</sup>. The performance relationship holds for immobilization of any reactant in a solid phase bioassay sequence<sup>1</sup>.



**Fig. 1.**

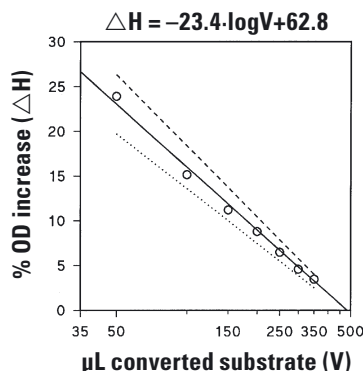
**Data of IgG adsorption kinetics with MaxiSorp StarWell (★) and standard well (□) using IgG:HRP conjugate (Dako P 128) and IgG (Dako Z 181) diluted in carbonate buffer, pH 9.6.**

In one case, 150  $\mu\text{L}$ /well of IgG:HRP conjugate was used in a dilution corresponding to 1% surface saturation of a standard well, i.e.  $F_{\square} = 0.01$  (left). In another case, 150  $\mu\text{L}$ /well of IgG + IgG:HRP (= 99+1) was used in a dilution corresponding to 100% standard well saturation, i.e.  $F_{\square} = 1$  (right).  $F$  generally denotes the ratio between the number of supplied molecules and the number of molecules that can be adsorbed. The MaxiSorp IgG adsorption capacity has been estimated to 650  $\text{ng}/\text{cm}^2$ , and at 150  $\mu\text{L}$  liquid volumes the StarWell and standard well surface/volume ratios are 1.5 x 8.3 and 8.3  $\text{cm}^{-1}$  respectively<sup>3</sup>. After adsorption, the wells were washed 3 times with PBS + 0.2 M extra NaCl + 0.05% Triton X-100, pH 7.2. This was followed by substrate reaction with 150  $\mu\text{L}$   $\text{H}_2\text{O}_2$ /OPD in phosphate-citrate buffer, pH 5.0, and addition of 110  $\mu\text{L}$  2N  $\text{H}_2\text{SO}_4$  stopping solution, implying 260  $\mu\text{L}$  reading volumes.

**Fig. 2.**  
**Relationship between OD increase and liquid volume with StarWell due to the fins' elevation of liquid heights.**

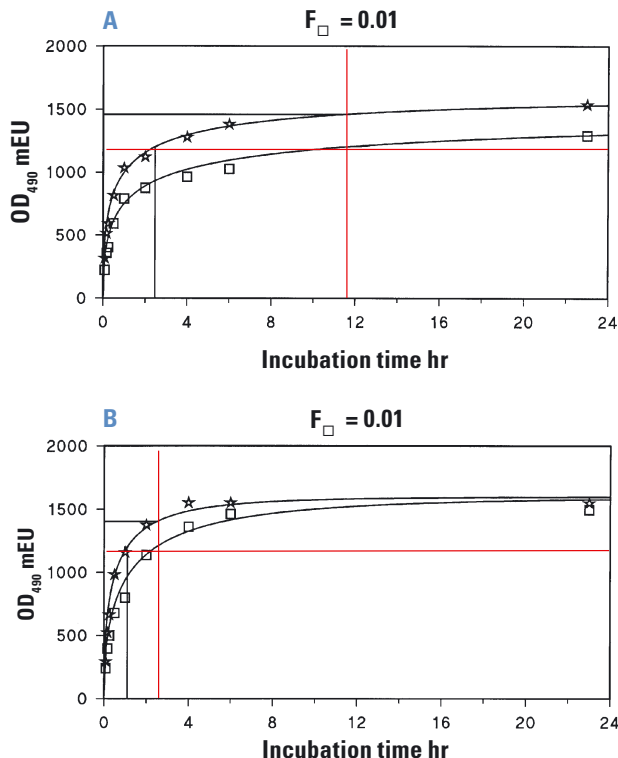
This relationship is empirically found to be approximately linear in a semilogarithmic plot. The dashed regression line represents the relationship with MaxiSorp, and the dotted line the relationship with PolySorp. The solid line and the equation represent the average data (O). In the hydrophobic PolySorp wells, the liquid stands higher than in the hydrophilic MaxiSorp wells due to the downward liquid surface curvature

in MaxiSorp. This gives rise to a higher MaxiSorp elevation percentage. Actual percentages are determined by multiplying or dividing the average calculation by 1.15 for MaxiSorp or PolySorp respectively. In the present case, using MaxiSorp and reading volumes of 260  $\mu\text{L}$ , the elevation is approximately 7%. The StarWell readings must therefore be reduced by 7% to match the standard well readings for a comparative analysis of the respective adsorption performances (Figs. 3-5).



**Fig. 3.**  
**Simulations of the Fig. 1 data, adjusted according to Fig. 2, by the adsorption kinetics model<sup>1</sup>, showing correlation between real and theoretical kinetics.**

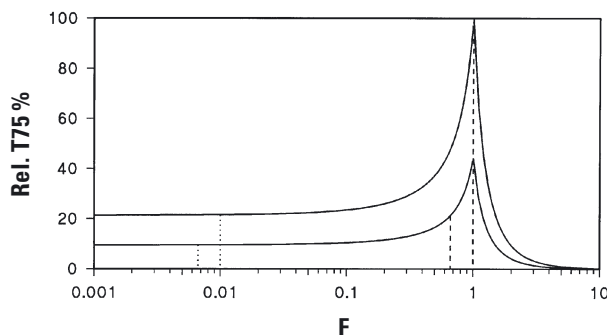
At molecular supplies corresponding to  $F_{\square} = 1$  (Fig. 3A), the StarWell adsorption acceleration is much larger than at molecular supplies corresponding to  $F_{\square} = 0.01$  (Fig. 3B). The reason for this is explained in Fig. 4. As an example, the levels of 75% adsorption of supplied molecules (red horizontal lines) are used for comparison of the StarWell vs. standard well performances. Between the lines of equal adsorption percentage (75%) and equal incubation time (red vertical lines), the StarWell curves exhibit regimes, elaborated in Fig. 5, where both time reduction and adsorption increase can be obtained.



**Fig. 4.**  
**Model derived incubation times,  $T_{75}$ , for 75% adsorption of supplied molecules, as functions of F, in percent of the standard well  $T_{75}$  value at  $F = 1$ , with StarWell (lower curve) and standard well (upper curve).**

The curves are almost constant for F values up to 0.1, because in this F regime, plenty of unoccupied sites are available on the surface. At  $F = 1$ , the curves assume maximum values, because the surfaces approximate saturation during adsorption; therefore, it will take a longer time for the last molecules to find the last unoccupied sites. In the present cases, where the molecular supplies correspond to  $F_{\square} = 0.01$  and 1, the corresponding StarWell values are 1.5 times smaller due to the 1.5 times

larger surface area, i.e.  $F_{\star} = 0.0067$  and 0.67, respectively. Therefore, a relatively larger StarWell adsorption acceleration is obtained at the high F values (dashed lines) than at the low F values (dotted lines) – in accordance with the data in Fig. 3. Thus,

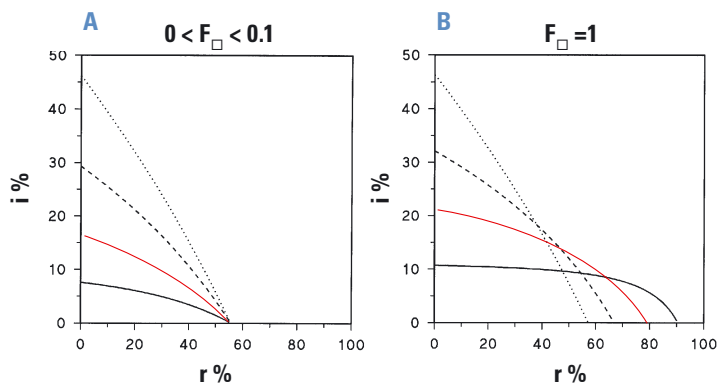


the claimed incubation time reduction factor of 2.25 is valid for  $F_{\square}$  values up to approximately 0.1. For  $F_{\square}$  values ranging from 0.1 to 1, the factor will be larger.

**Fig. 5.**

**Model derived adsorption increase (i) vs. incubation time reduction (r) with StarWell compared to standard well for 10% (···), 50% (---), 75% (—) and 90% (—) adsorption of supplied molecules.**

For  $F_{\square}$  values up to 0.1 (Fig. 5A) the maximum time reduction is approximately constant for any adsorption level. At  $F_{\square} = 1$  (Fig. 5B) the maximum time reduction increases with increasing adsorption level (Fig. 3). For  $F_{\square}$  values ranging from 0.1 to 1, a gradual transition from the left to the right diagram curves will occur. Between the extremes of maximum r (i = 0) and maximum i (r = 0), intermediate r and i values can be obtained with StarWell.



## References

- Esser P. (1992).  
The surface/volume ratio in solid phase assays.  
Thermo Scientific Nunc Bulletin No. 10.
- Esser P. (1988).  
Principles in adsorption to polystyrene.  
Thermo Scientific Nunc Bulletin No. 6.
- Esser P. (1985).  
Adsorption geometry in Thermo Scientific Nunc Immuno products.  
Thermo Scientific Nunc Bulletin No. 1.

[www.thermoscientific.com/oemdiagnostics](http://www.thermoscientific.com/oemdiagnostics)

© 2010 Thermo Fisher Scientific Inc. All rights reserved. "Dako" is a registered trademark of Dako Denmark A/S. All other trademarks are the property of Thermo Fisher Scientific Inc. and its subsidiaries.



# Thermo Scientific Nunc FluoroNunc Plates and Modules:

## A Solid Phase for Fluorescent Immuno Assays

This Tech Note describes the use of white Thermo Scientific Nunc FluoroNunc C96 plates and white C8 modules in a fluorescence immuno assay.

The use of fluorescence techniques in solid phase diagnostic assays is attracting increasing attention due to the higher sensitivity which can potentially be obtained. Sensitivity, however, is not only a question of the right detection system, but is also dependent on the performance of the solid phase used.

The Nunc™ FluoroNunc™ plates and modules have been developed in a transparent version for use in time resolved fluorescence assays where the plate background is minimized. The black version minimizes light scattering, while the white version is used for high sensitivity in traditional fluorescence assays (Tech Note No. 6).

All the FluoroNunc products can be obtained with Thermo Scientific Nunc PolySorp or MaxiSorp surface which provides the binding properties needed to make the most sensitive and reliable assay.

To demonstrate the use of white FluoroNunc plates and modules we have designed a sandwich assay for detection of IgG.

### Materials and Method

Solid phase: FluoroNunc Plate, White C96 MaxiSorp™.

Antibodies: Pig anti-rabbit, Rabbit anti-sheep, Pig anti-rabbit alkaline phosphatase conjugate.

Buffers: Carbonate buffer

0.05M pH 9.6. Phosphate buffered saline 0.15M pH 7.2 (PBS). Assay buffer: PBS with 0.05% Tween 20. Wash buffer: PBS with 0.2 M NaCl and 0.05% Triton X100.

Substrate: 0.1 mm 4-methyl-umbelliferylphosphate in diethanolamine buffer pH 9.8.

Miscellaneous: Bovine serum albumin.

Stop solution: 3 M  $K_2HPO_4$ , 150  $\mu$ L carbonate buffer containing 5  $\mu$ g/mL PaR antibody was added to each well. The wells were sealed with adhesive foil.

The plates were coated overnight at room temperature. Then the plates were washed once with demineralized water. Blocking solution (400  $\mu$ L PBS with 0.5% BSA) was added to all the wells and the plates incubated for 10 minutes at room temperature. The wells were completely aspirated, and a 1:2 dilution series of RaS, 150  $\mu$ L/well, was performed in the plates (starting in column 2 at a concentration of 420 ng/mL). Assay buffer was added to column 1. The plates were incubated for 2 hours at room temperature, then washed 5 times with wash buffer using Thermo Scientific Nunc Immuno Washer.

Conjugate in assay buffer, 150  $\mu$ L/well, was added to all wells in dilution 1:500 or 1:5000, and the plates incubated for 2 hours at room temperature. After the plates had been washed 5 times with wash buffer the substrate reaction was initiated by adding 150  $\mu$ L/well of substrate. The reaction was stopped after 15, 30 or 45 minutes, by adding stop solution.

The fluorescent results were read on a fluorescence reader and the data collected on computer using in house software.

### Results

The results of this test are shown in Fig. 1 and graphically in Fig. 2.

As can be seen the best sensitivity was obtained using conjugate in a dilution of 1:500 and a substrate reaction time of 30 minutes. No improvement in sensitivity was observed when the substrate reaction time was increased to 45 minutes. Data analysis, using background (Bg) signal plus 2 SD as cut off value showed that a detection of 20-40 pg/mL RaS antibody could be clearly obtained in this test.

### Discussion

The successful performance of solid phase fluorescent technique is dependent on the solid phase used just as much as on a reliable detection system. The result of this test has shown that a sensitive fluorescent assay can be obtained on FluoroNunc white plates and modules. Furthermore, these products have the same quality of surface performance as all Immuno™ products. Existing chromogenic tests designed on PolySorp™ or MaxiSorp surfaces can therefore easily be transferred to fluorescence tests by using FluoroNunc plates or modules and simply changing the substrate to a fluorescent substrate offering an increased assay sensitivity.

**Fig. 1**  
Results of fluorescence assay

**15 min; 1:500**

ng/mL IgG	0.01	0.02	0.04	0.08	0.16	0.31	0.625	1.25	Bg
Mean	26.77	25.41	38.98	54.39	82.12	148.2	274.3	551.3	8.91
SD	11.11	5.253	13.45	14.24	7.941	6.554	16.32	28.32	4.77
2 SD	22.22	10.506	26.9	28.48	15.882	13.108	32.64	56.64	9.548
Mean + 2 SD	48.99	35.916	65.88	82.87	98.002	161.308	306.94	607.94	18.459
Mean - 2 SD	4.55	14.904	12.08	25.91	66.238	135.092	241.66	494.66	

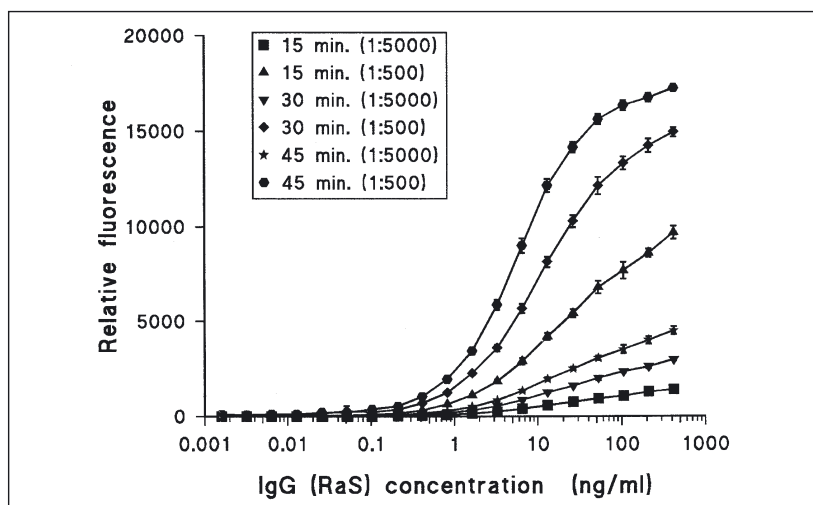
**30 min; 1:500**

ng/mL IgG	0.01	0.02	0.04	0.08	0.16	0.31	0.625	1.25	Bg
Mean	41.03	53.07	76.4	116.7	179.2	315.6	614.2	1145	21.21
SD	10.44	9.865	12.42	29.56	9.282	22.68	20.56	59.57	5.594
2 SD	20.88	19.73	24.84	59.12	18.564	45.36	41.12	119.14	11.188
Mean + 2 SD	61.91	72.8	101.24	175.82	197.764	360.96	655.32	1264.14	32.398
Mean - 2 SD	20.15	33.34	51.56	57.58	160.636	270.24	573.08	1025.86	

**45 min; 1:500**

ng/mL IgG	0.01	0.02	0.04	0.08	0.16	0.31	0.625	1.25	Bg
Mean	66.38	84.29	131	194.5	298.6	542	1018	1949	56.28
SD	18.35	21.22	38.62	50.23	17.88	40.8	39.1	75.32	16.54
2 SD	36.7	42.44	77.24	100.46	35.76	81.6	78.2	150.64	33.08
Mean + 2 SD	103.08	126.73	208.24	294.96	334.36	623.6	1096.2	2099.64	89.36
Mean - 2 SD	29.68	41.85	53.76	94.04	262.84	460.4	939.8	1798.36	

**Fig. 2**  
Graphical representation



[www.thermoscientific.com/oemdiagnostics](http://www.thermoscientific.com/oemdiagnostics)

© 2010 Thermo Fisher Scientific Inc. All rights reserved. "Tween" is a registered trademark of Uniqema Americas; and "Triton" is a registered trademark of Dow Chemical Company. All other trademarks are the property of Thermo Fisher Scientific Inc. and its subsidiaries.

# In Situ Screening of Bacterial Colonies - Protocols

Patrick Eldin, Faculté de Pharmacie, Montpellier, France

Positive clones are selected after plasmid cloning. This is often done by DNA probe hybridization in situ to plasmid DNA containing E.coli cells. The following protocol can be used for most plasmid cloning events in E.coli cells.

## I - Protocol for DNA screening of bacterial colonies

Transformation is performed as usual.

### A. Dot Blot of bacterial clones

1. Colonies are plated on LB Agar medium (petri dishes) with the correct antibiotic.
2. Following an overnight incubation at 37°C individual colonies are picked (with a tooth pick) and inoculated into single wells of a Thermo Scientific Nunc MicroWell Plate 96F pre-filled with LB-medium containing the appropriate antibiotic.
3. Following an overnight incubation at 37°C, a disposable TSP 96 Pin Replicator is used to replicate all individual colonies from one plate to a nylon hybridization filter (e.g. Thermo Scientific Nunc Pall Biotodyne B Nylon Membrane) (Fig. 1). Allow filter to air-dry.  
At this stage, add one tenth volume of glycerol to each well of the 96 Nunc™ MicroWell™ plate overnight culture to allow the storage of the colonies at -80°C.
4. The air-dried nylon filter is then placed (colonies facing up) on a Thermo Scientific Nunc OmniTray previously filled with LB Agar containing appropriate

antibiotic. Incubate overnight 37°C to allow the cells to grow on the filter.

### B. Bacterial Lysis on filter

1. The alkaline lysis is performed as follows:
  - 1.0 mL of the lysis solution (0.5 N NaOH) is placed in an OmniTray™. The filter is placed on top of the lysis solution with the colony side up. Incubate at room temperature for 10 minutes. The solution diffuses through the filter and lyses the cells during the incubation.
  - The same incubation is repeated with a fresh lysis solution.
2. At the end of the second 10 minutes incubation the filter is neutralized using 1 mL of Tris 1M pH 5.4.  
Repeat this treatment twice.
3. The filter is air-dried and the DNA fixed or cross-linked on the filter, depending on the type of filter used.

The filter is now ready to be processed for hybridization with a labeled DNA probe (cDNA or oligonucleotide, radioactive or non-radioactive). When radioactive labeling with <sup>32</sup>P is used the auto-radiogram is developed (e.g. Kodak XAR film) after appropriate exposure with intensifying screen at -80°C. It is easy to identify a positive clone and to carry out further analysis starting with the corresponding frozen clones as the individual colonies are well aligned and discrete.

### Additional applications

The protocol for DNA screening is used for selection of modified plasmids, but other systems can be applied as well.

At the end of the coding sequence of human  $\beta$ -myosin heavy chain ( $\beta$ -mhc) segment, a specific immuno TAG (NH<sub>2</sub>-YEEEEYYEEE COOH) was introduced against which there is a monoclonal antibody. In this way, a specific detection of the corresponding protein product after transfection in muscle cells is accomplished. After insertion of a 34 bp segment, encoding the TAG at the 3'-end of the  $\beta$ -mhc coding sequence in an expression plasmid, colonies were screened for correct insertion of the radio-labeled TAG oligonucleotides.

Results for one MicroWell plate 96F with two positive controls in the bottom (Fig. 2).

## II - Protocol for in situ immunoscreening of bacterial colonies

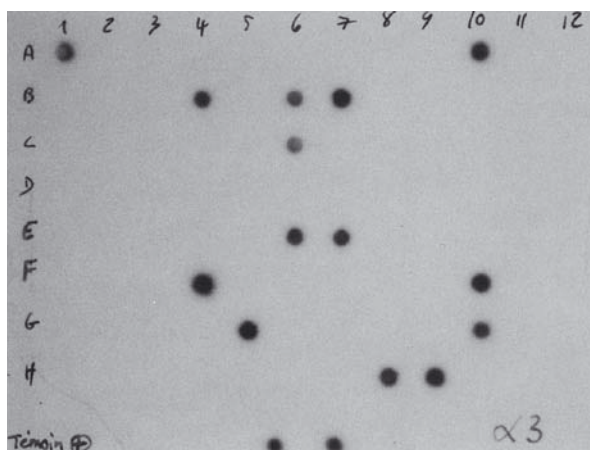
When an inducible expression vector is used, the same colonies can be screened with monoclonal or polyclonal antibodies with slight modifications of the bacterial lysis.

### A. Dot Blot of bacterial clones

Procedure is the same as for in situ DNA screening previously presented, except in this case an inducible expression vector is used (e.g. a temperature inducible expression vector such as the pEX vectors).



**Fig. 1** - By using the disposable TSP 96 Pin Replicator all individual colonies of a plate are replicated on a nylon hybridization filter (e.g. Pall Biotodyne B Nylon Membrane).



**Fig. 2** - DNA screening for selection of modified plasmids. Positive clones are A1,10; B4, 6, 7; C6; E6, 7; F4, 10; G5, 10; H8, 9. At the bottom two positive controls are shown.

### B. Induction of recombinant protein expression on filters

Induction of expression must be made on the filter (after step I.A.4 above) by adding the specific inducer (IPTG for example) or by switching temperature from 30°C to 42°C if you use a pEX vector, dependent on the promoter used for expression.

### C. Bacterial Lysis on filter

1. The lysis is performed by placing the filter containing bacterial colonies face up (Nitrocellulose Millipore HATF) on three sheets of Whatman 3 mm paper previously soaked in 5% SDS followed by heating in a microwave oven for one minute at full power (approximately 650 W).

2. SDS is then removed by an electro-transfer in Tris 20 mm, Glycine 160 mm, in a 2x2 Whatman sheet sandwich, at 50 volts for 30 min. Place the colony side facing the negative electrode.
3. Blockage of non-specific binding is performed by overnight incubation at 4°C in TBS-Tween containing 1% BSA and DNase I grade II at 10 mg/mL. The filter can then be treated in an ordinary Western blot procedure (e.g. primary antibody incubation, washings, secondary antibody coupled to alkaline phosphatase or peroxidase incubation and visualization with the adapted substrates for color development).

### Buffers

TBS-Tween: 10 mm Tris-HCl, pH 8.0, 150 mm NaCl, 0.05% Tween 20.

AP: 100 mm Tris-HCl, pH 9.5, 100 mm NaCl, 5 mm MgCl<sub>2</sub>.

NBT/BCIP substrate: for 10 mL solution add 66 µL of NBT solution (Nitro Blue Tetrazolium at 75 mg/mL in 70% dimethyl formamide) and 33 µL of BCIP solution (5-bromo-4-chloro-3-indolyl phosphate, at 50 mg/mL in 100% dimethyl formamide) to 10 mL of AP buffer.

# High Sensitivity Detection of Antigens using Immuno PCR

Christof M. Niemeyer, Michael Adler and Dietmar Blohm

Universität Bremen, Abteilung Biotechnologie und Molekulare Genetik Bremen, Germany

The detection of nucleic acids can be achieved at levels of a few molecules using the polymerase chain reaction (PCR). In contrast, the analysis of proteins using conventional methods, such as enzyme-linked immuno-sorbent assay (ELISA), hardly surpasses sensitivity levels below  $1 \times 10^{-18}$  mol of the antigen. By combining the enormous amplification power of PCR with antibody-based immuno-assays, Immuno PCR (I-PCR) allows the detection of proteins at a level of a few hundred molecules<sup>1</sup>. In this Tech Note, a sandwich I-PCR (Fig. 1)<sup>2</sup> and the analysis of the I-PCR amplicons in a Thermo Scientific Nunc MicroWell format are described.

The successful establishment of I-PCR as a routine method is dependent on using a reaction vessel in a Nunc™ MicroWell™ plate format, with high protein binding capacity and sufficient thermal stability to allow both initial immuno-reactions and subsequent thermal cycling.

A standardised protocol for reagent preparation and a rapid and reliable method for the analysis

and quantification of the amplified DNA are also required.

## Methods

Preparation of MicroWell plates antibody coated plates are prepared using heat stable Thermo Scientific Nunc TopYield Strips. Add 30 µL of a capture antibody diluted at 20 µg/mL to each well.

Incubate overnight at 4°C. Wash three times with Buffer B (10 mm Tris, pH 7.3, containing 150 mm NaCl) and block overnight at 4°C with 150 µL of Buffer C (Buffer B containing 4.5% skim milk powder, 0.2% NaN<sub>3</sub>, 5 mm EDTA and 1 mg/mL hering sperm DNA). Wash four times with Buffer D (Buffer B containing 0.05% Tween 20 and 5 mm EDTA). Streptavidin coated plates are used for the enzyme-based detection of I-PCR amplicons.

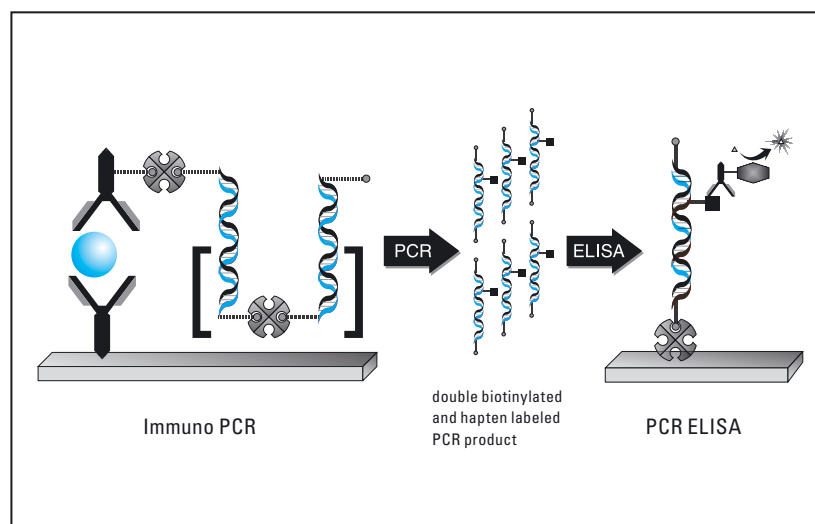
## Preparation of DNA Streptavidin Reagents

A bis-biotinylated DNA reporter fragment is prepared from M13mp18 DNA template by PCR using biotinylated primers. Conjugates of recombinant STV and the bis-biotinylated DNA

fragment are prepared by adding 2 pmol of STV in 1 µL Buffer E (10 mm Tris-HCl, pH 7.3, 5 mm EDTA) to 13 µL of Buffer E, and subsequently, 1 pmol of the bis-biotinylated DNA in 1 µL Buffer E. The mixture is incubated for 15 minutes at room temperature.

## Immuno PCR

The antigen-capture step of the sandwich I-PCR is carried out with 1:3-1:10 serial dilutions of the antigen containing sample. 30 µL of the diluted samples are added to the wells of the antibody coated TopYield™ Strips and incubated for one hour at room temperature. Wash three times with Buffer D. Add 30 µL of the biotinylated detection antibody (3.5 mg/mL in Buffer F). Add 30 µL oligomeric DNA streptavidin (5 pm in Buffer F). Incubate for 30 minutes. Wash six times with Buffer D and twice with Buffer B. PCR is carried out directly in the TopYield Strips in 29 cycles. PCR reaction mix contains 11-digoxigenin-dUTP to allow quantification of the I-PCR amplicons using the MicroWell assay described below.



**Fig. 1.**

Immuno PCR detection of an antigen with subsequent quantitative analysis of product yields by PCR ELISA. Capture antibodies are immobilized on MicroWell plates to bind the antigen selectively. Sequential coupling of a biotinylated detection antibody, streptavidin, and a biotinylated DNA marker assemble a signal generating immunocomplex. Signal amplification by PCR using a biotinylated primer and a digoxigenin labeled nucleotide generates doubly labeled amplicon which can be quantified in a PCR ELISA. The PCR products are immobilized on streptavidin coated plates and analysed by anti-digoxigenin IgG-alkaline phosphatase conjugate with either chromogenic or fluorogenic substrates.

### Analysis of I-PCR Amplicons

I-PCR amplicons can be detected by gel-electrophoresis, or in a MicroWell plate format. The latter is advantageous, since it allows for quantification of a large number of samples, and also further enhances the sensitivity of I-PCR. I-PCR products are diluted 1:80 for colorimetric detection, or 1:800 for fluorescence detection with Buffer D, and 50  $\mu$ L are added to the streptavidin coated MicroWell plate. Incubate for 45 minutes at room temperature. Wash five times with Buffer D. Add 50  $\mu$ L of a 1:5000 dilution of anti-Digoxigenin IgG-alkaline phosphatase conjugate in Buffer D. Incubate for 45 minutes at room temperature. Wash three times with Buffer D and three times with Buffer B.

For colorimetric detection, add 200  $\mu$ L of 1 M diethanolamine, pH 9.8, and 0.5 mM  $MgCl_2$  containing 10 mM p-nitrophenyl phosphate. The reaction is quenched after 60 minutes at 37°C by adding EDTA. Read the result at 405 nm.

For fluorescence detection, AttoPhos substrate may be used, prepared according to manufacturer's instructions. The plates are incubated 30 minutes at 37°C and analysed on a

fluorescence reader with 440 nm excitation and 550 nm emission wavelengths.

### Results

A comparative study with a mouse IgG as model antigen using either a sandwich ELISA or sandwich I-PCR is shown in Fig. 2. As can be seen a 1:1000 enhancement in sensitivity is obtained from the employment of I-PCR instead of the ELISA technique.

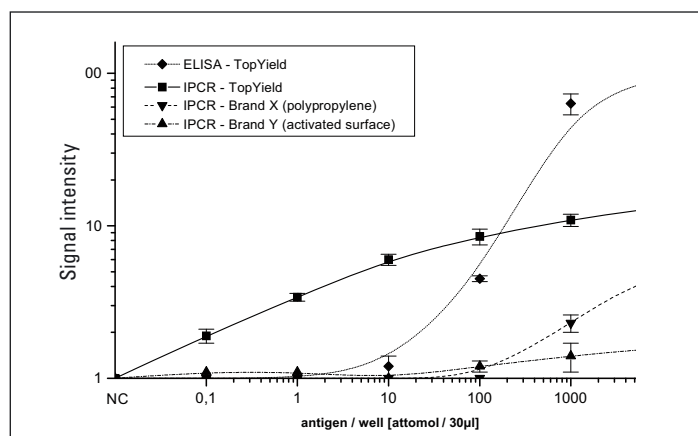
The signal intensities of I-PCR are linearly dependent on the amount of antigen, and the dynamic range of the assay often exceeds five orders of magnitude.

The influence of the MicroWell plate used in the I-PCR is also evident from the curves in Fig. 2. TopYield Strips are compared with two other temperature resistant reaction vessels. Brand X, made of polyethylene, was coated with capture antibody as described above. Brand Y, containing a chemically activated surface capable of binding antibodies covalently as well as other proteins, was coated with capture antibody according to manufacturer's instructions. A sandwich- I-PCR was carried out for the detection of the mouse IgG antigen. Using

TopYield, a sensitivity of less than 0.1 amol of antigen is seen in the I-PCR while the protein binding capacity of Brand X is not sufficient for an immuno-assay. The use of Brand Y plates leads to a limited sensitivity of about 100 amol of antigen.

### References

1. Sano T, Smith CL and Cantor CR.  
Immuno-PCR: Very sensitive antigen detection by means of specific antibody-DNA conjugates.  
*Science* (1992), 258, 120-122.
2. Niemeyer CM, Adler M and Blohm D.  
Fluorometric Polymerase Chain Reaction (PCR) Enzyme-Linked Immunosorbent Assay for Quantification of Immuno-PCR Products in Microplates.  
*Anal. Biochem.* (1997), 246, 140-145.
3. Niemeyer CM, Adler M, Pignataro B, Lenhart S, Gao S, Chi L, Fuchs H and Blohm D.  
Self-Assembly of DNA-Streptavidin Nanostructures and their Use as Reagents in Immuno-PCR. *Nucleic Acids Res.* (1999), 27, 4553-4561.



**Fig. 2.**

Detection of IgG using a direct immuno PCR assay with a subsequent AttoPhos PCR ELISA.

Detection of mouse and rabbit IgG was carried out from 1:10 serial dilutions of antigen in the range of 150 pg (1 fmol) to 1.5 fg (0.01 amol). The error bars indicate the maximum deviation observed for independent immuno PCR detections of the antigens.

www.thermoscientific.com

© 2011 Thermo Fisher Scientific Inc. All rights reserved. "AttoPhos" is a registered trademark of Roche Applied Science. All other trademarks are the property of Thermo Fisher Scientific Inc. and its subsidiaries.

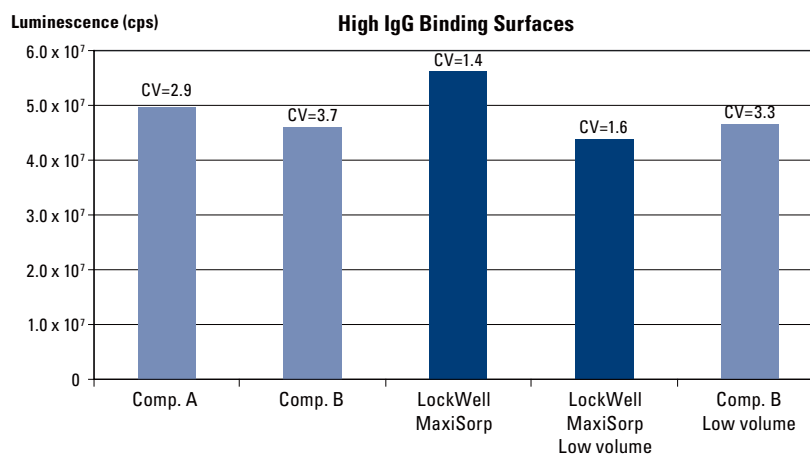
# Thermo Scientific Nunc C8 White LockWell LumiNunc MaxiSorp and PolySorp for Luminescence Detection

The new white Thermo Scientific Nunc LockWell is available with Thermo Scientific Nunc MaxiSorp and PolySorp surfaces. The format is constructed as a breakable module with letters and notches on each well for easy identification and a maximum volume of 350  $\mu\text{L}$ /well. The format makes the modules suitable for all commonly used automated equipment. The white LockWell™ modules are densely pigmented to obtain high reflection and minimize crosstalk. MaxiSorp is optimized for binding of IgG (antibodies), and PolySorp for binding more hydrophobic molecules.

The purpose of this study is to compare the performance of the white LockWell modules with similar products from other large suppliers: Competitor A, B and B low volume (total volume of 205  $\mu\text{L}$ /well). Plate uniformity and binding capability are measured by detection of immobilized horseradish peroxidase (HRP) from coating with a mixture of rabbit IgG and HRP conjugated rabbit anti-mouse IgG.

Three plates of each type were tested on three independent days.

The highest binding capability and lowest relative standard deviation between high binding surfaces was found to be LockWell MaxiSorp using coating volumes of 150  $\mu\text{L}$ /well (Fig. 1). Comparing the LockWell format to Competitor B low volume, using a coating volume of 100  $\mu\text{L}$ /well, a very low relative standard deviation is still achieved with LockWell. Also, when using the LockWell for



**Fig. 1.**

Luminescence signal (antibody binding capability) measured after performing antibody binding assay on different high binding surfaces. Coating volume of Competitor A, B and MaxiSorp modules was 150  $\mu\text{L}$ /well, and coating volume of MaxiSorp and competitor B low volume was 100  $\mu\text{L}$ /well. Mean CV for tested module plates is indicated above the respective binding capability column.

low volume coatings, the binding capability is comparable to the Competitor B low volume. The binding capability of the LockWell MaxiSorp surface can easily be increased by using a higher coating volume.

## Assay

Coating overnight at room temperature with antibody mixture (100  $\mu\text{L}$ /well using low volume or 150  $\mu\text{L}$ /well using standard 96 format).

Wash 3X with washing buffer.

Addition of luminol substrate (100  $\mu\text{L}$ /well using low volume or 150  $\mu\text{L}$ /well using standard 96 format).

Immediately after adding of substrate, the luminescence intensity is measured on EnVision 2101 using optimized ultra-sensitive luminescence protocols, reading time 0.1 sec.

## Reagents

Antibody mixture consisting of 65 ng/mL HRP conjugated rabbit anti-mouse IgG P0260 and 10  $\mu\text{g}$ /mL Rabbit IgG X0903, diluted in 0.05 M sodium carbonate buffer, pH 9.6.

Washing buffer: 0.15 M PBS, pH 7.2, with 0.05% detergent (Triton X for high binding surfaces and Tween 20 for medium binding surfaces).

Luminol stock solution: 0.32 M 3-(p-aminophthalhydrazide) and 0.36 M 4-iodophenol dissolved in dimethyl sulfoxide.

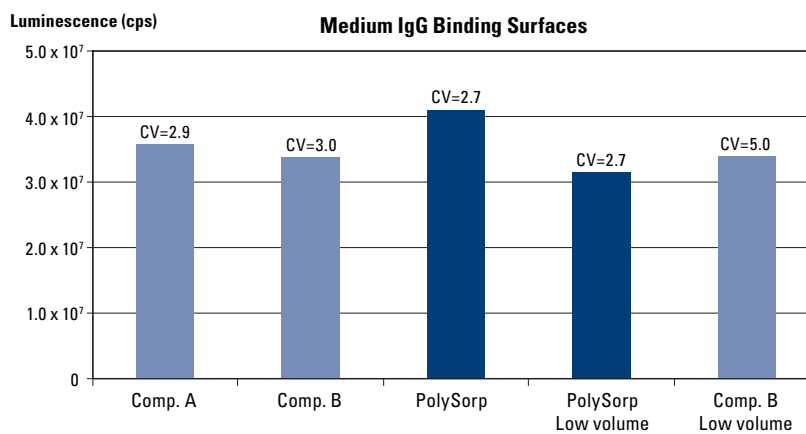
Dilute both luminol stock solution and a 0.3 % hydrogen peroxide solution 1:250 in 0.1 M TRIS buffer, pH 8.5.

The highest binding capability between medium binding surfaces was found to be LockWell PolySorp using coating volumes of 150  $\mu\text{L}$ /well (Fig. 2), while

the relative standard deviations are comparable. Comparing the LockWell format to Competitor B low volume, a very low relative standard deviation is achieved using a coating volume of 100  $\mu$ L/well. The binding capability when using the LockWell for low volume coatings is comparable to the Competitor B low volume. The binding capability of the LockWell PolySorp surface can easily be increased by using a higher coating volume.

### Conclusion

Data show high binding capability and high uniformity using luminescence detection on white Thermo Scientific Nunc C8 LockWell LumiNunc, demonstrated for different coating volumes by IgG binding assay on both the MaxiSorp and PolySorp surfaces.



**Fig. 2.**

Luminescence signal (antibody binding capability) measured after performing antibody binding assay on different medium binding surfaces. Coating volume of Competitor A, B and PolySorp modules was 150  $\mu$ L/well, and coating volume of PolySorp and competitor B low volume was 100  $\mu$ L/well. Mean CV for tested module plates is shown above respective binding capability column.



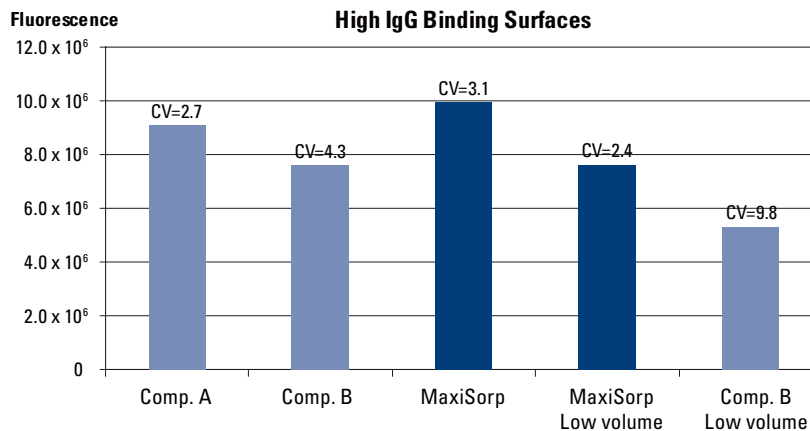
# C8 Black Thermo Scientific Nunc LockWell FluoroNunc MaxiSorp and PolySorp for Fluorescence Detection

The new black Thermo Scientific Nunc LockWell format with MaxiSorp and PolySorp wells have a recommended maximum volume of 350  $\mu\text{L}$ . These breakable strips have letters and notches on each well for easy identification of individual wells. The strips are suitable for all commonly used automated equipment. The dense pigmentation of black Nunc LockWell™ modules minimizes background fluorescence.

MaxiSorp™ is optimized for binding IgG (antibodies) and PolySorp™ for binding more hydrophobic molecules.

In this study we compare the performance of the black LockWell modules with similar products from other large suppliers: Competitors A, B and B low volume (total volume of 205  $\mu\text{L}$ /well). Plate uniformity and binding capability are determined by monitoring the reaction of immobilized horseradish peroxidase (HRP) from coating with a mixture of rabbit IgG and HRP conjugated rabbit anti-mouse IgG. Three of each plate type were tested on three different days.

When comparing high binding surfaces, the highest binding capability and lowest relative standard deviation was found to be LockWell MaxiSorp and Competitor A (using coating volumes of 150  $\mu\text{L}$ /well) (Fig. 1). Comparing the LockWell format to Competitor B low volume (using a coating volume of 100  $\mu\text{L}$ /well) a very low relative standard deviation and high binding capability was



**Fig. 1.**

Fluorescence intensity (antibody binding capability) measured after performing antibody binding assay on different medium binding surfaces. Coating volume of Competitor A, B and MaxiSorp modules was 150  $\mu\text{L}$ /well, and coating volume of PolySorp and competitor B low volume was 100  $\mu\text{L}$ /well. Mean CV for tested module plates is shown above the respective binding capability column.

found for the LockWell format.

The binding capability of the LockWell MaxiSorp surface can easily be increased using a higher coating volume.

## Assay

- Coating overnight at room temperature with antibody mixture (100  $\mu\text{L}$ /well using low volume or 150  $\mu\text{L}$ /well using standard 96 format).
- Wash three times with washing buffer.
- Addition of HPPA substrate (100  $\mu\text{L}$ /well using low volume or 150  $\mu\text{L}$ /well using standard 96 format).
- Addition of 50  $\mu\text{L}$ /well sodium hydroxide after 14 minutes. The fluorescence was measured on EnVision 2101 using optimized fluorescence protocols with filter sets 340/405 and 485/535 nm.

## Reagents

Antibody mixture consisting of 65 ng/mL HRP conjugated rabbit anti-mouse IgG and 10  $\mu\text{g}$ /mL rabbit IgG, diluted in 0.05 M sodium carbonate buffer, pH 9.6.

Washing buffer: 0.15 M PBS, pH 7.2, with 0.05% detergent (Triton X for high binding surfaces and Tween 20 for medium binding surfaces).

Freshly prepared HPPA substrate: 2.5 mm 3-(p-hydroxyphenyl) propionic acid dissolved in 0.1 M TRIS buffer, pH 8.5, and 1.5  $\mu\text{L}$  30% hydrogen peroxide is added to 100 mL substrate.

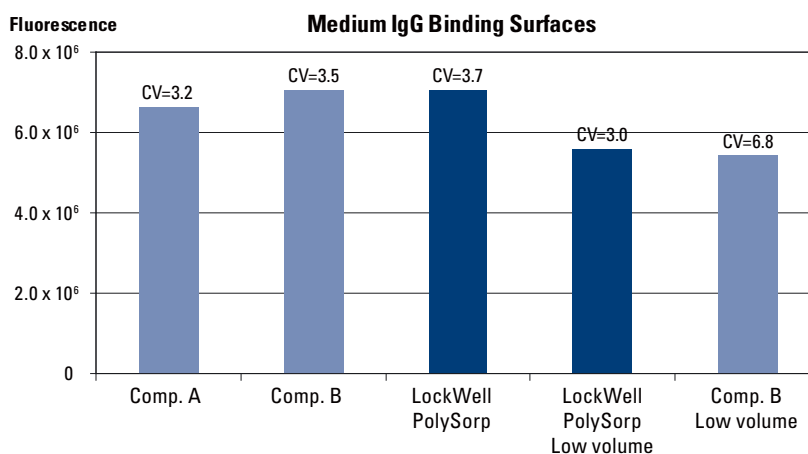
Binding capability and relative standard deviations between medium binding surfaces was found to be comparable, using coating volumes of 150  $\mu\text{L}$ /well (Fig. 2). Comparing the LockWell

format to Competitor B low volume, a very low relative standard deviation is achieved using a coating volume at 100  $\mu\text{L}/\text{well}$ . The binding capability when using the LockWell for low volume coatings is comparable to the Competitor B low volume. The binding capability of the LockWell PolySorp surface can easily be increased using a higher coating volume.

Fluorescence background measurements were performed using excitation and emission filter sets 485/535 and 340/405 nm. The data are not shown, as it was found relatively low for all products, regardless of the surface type and format.

### Conclusion

Data show high binding capability and high uniformity using fluorescence detection on black C8 LockWell FluoroNunc™, demonstrated for different coating volumes by IgG binding assay on both the MaxiSorp and PolySorp surfaces.



**Fig. 2.**

Fluorescence intensity (antibody binding capability) measured after performing antibody binding assay on different high medium surfaces. Coating volume of Competitor A, B and PolySorp modules was 150  $\mu\text{L}/\text{well}$ , and coating volume of PolySorp and competitor B low volume was 100  $\mu\text{L}/\text{well}$ . Mean CV for tested module plates is shown above each relevant binding capability column.

# Binding of Low Density Lipoprotein Particles to Human Aortic Proteoglycans in Enhanced Binding Thermo Scientific Microtiter Microplates

Mia Sneek, Petri T. Kovanen and Katariina Öörni, Wihuri Research Institute, Finland  
Irmgard Suominen, Thermo Fisher Scientific

## Abstract

Binding of low density lipoprotein (LDL) to proteoglycans and modification of LDL are key processes in atherogenesis. In this application note we describe a method for studying LDL binding to proteoglycan in microplate-format.

## Introduction

Accumulation of cholesterol in the inner layer of the arterial wall, the intima, leads to the development of atherosclerotic lesions, the lesional cholesterol being mostly derived from circulating low density lipoprotein (LDL) particles. Once LDL particles have entered the subendothelial space they are entrapped by the extracellular matrix, particularly by intimal proteoglycans, which form an organized, negatively charged, tight network. The retention of LDL particles by proteoglycans is considered to have key role in the development of atherosclerosis. In this application note we describe a method for studying the binding of LDL particles to human aortic proteoglycans.

## Materials and methods

### Isolation and modifications of LDL

Human LDL ( $d = 1.019\text{--}1.050$  g/mL) was isolated from plasma of healthy volunteers by sequential ultracentrifugation in the presence of 3mM EDTA<sup>1,2</sup>. The amounts of LDL are expressed in terms of their protein concentrations, which were determined by the method of Lowry et al.<sup>3</sup> with bovine serum albumin as a standard.

### Preparation and characterization of aortic proteoglycans

Proteoglycans from the intima-media of human aortas were obtained at autopsy within 24 hours of accidental death and were prepared essentially by the method of Hurt-Camejo et al.<sup>4</sup>, as described previously<sup>5</sup>. Glycosaminoglycans were quantified by the method of Bartold and Page<sup>6</sup>, and the amounts of proteoglycans are expressed in terms of their glycosaminoglycan content.

### Binding of LDL to human aortic proteoglycans

The wells of Thermo Scientific polystyrene 96 well microplates (enhanced binding) were coated with 100 $\mu$ L of human aortic proteoglycans (50 $\mu$ g/mL in phosphate-buffered saline) by incubation at 4°C overnight. Wells were blocked with 3% BSA, 1% fat-free milk powder, and 0.05% Tween 20 surfactant in phosphate-buffered saline for 1 hour at 37°C. Wells without proteoglycans served as controls.

100 $\mu$ L of LDL (0.02-0.2mg/mL) in a buffer containing 1% BSA, 140mM NaCl, 2mM CaCl<sub>2</sub>, 2mM MgCl<sub>2</sub> and 20mM MES (pH 5.5) was incubated in the wells for 1 hour at 37°C, unbound LDL was removed, the wells were washed with MES buffered 50mM saline, and the amounts of bound LDL were determined using the Amplex Red cholesterol kit. The amount of bound LDL is expressed as  $\mu$ g of LDL protein/well, which was calculated from the amounts of cholesterol (2.7nmol of cholesterol/ $\mu$ g of LDL protein).

## Results and Discussion

The binding of LDL to human aortic proteoglycans was examined in microtiter well assays at pH 5.5. For this purpose, the wells were coated with the proteoglycans with BSA-coated wells serving as controls. LDL was incubated in the proteoglycan or BSA-coated wells, the unbound LDL was removed, and the amount of bound LDL was measured. As shown in Fig. 1, LDL binds to aortic proteoglycans in the microplate assay. Results shown are the average  $\pm$  SD of incubations performed in quadruplicate. For some data points, the sizes of symbols are larger than the error bars. A saturation level is observed at a concentration of 20 $\mu$ g LDL/well.

## Conclusions

The assay described here is suitable for studying binding of LDL to human aortic proteoglycans. The assay can be used for determining the effect of micro-environmental factors (like pH) or modifications of LDL on binding to proteoglycans.

## Abbreviations

LDL: low density lipoprotein  
BSA: bovine serum albumin  
MES: 4-morpholineethanesulfonic acid

## References

This application note is based on:  
Sneck M, Kovanen PT and Öörni K.  
Decrease in pH strongly enhances  
binding of native, proteolyzed,  
lipolyzed and oxidized low density  
lipoprotein particles to human  
aortic proteoglycans.

J Biol Chem 2005;280,  
37449–37454.

1. Mahley RW, Weisgraber KH and  
Innerarity TL.

Interaction of plasma  
lipoproteins containing  
apolipoproteins B and E  
with heparin and cell surface  
receptors.

Biochim. Biophys. Acta  
1979;575, 81–91.

2. Radding CM and Steinberg D.  
Studies on the synthesis and  
secretion of serum lipoproteins  
by rat liver slices.

J. Clin. Invest. 1960;39,  
1560–1569.

3. Lowry OH, Rosebrough NJ,  
Farr AL and Randall RJ.  
Protein measurement with the  
Folin phenol reagent.

J. Biol. Chem. 1951;193,  
265–275.

4. Hurt-Camejo E, Camejo G,  
Rosengren B, Lopez F, Wiklund  
O and Bondjers G.

Differential uptake of  
proteoglycan-selected  
subfractions of low density  
lipoprotein by human  
macrophages.

J. Lipid Res. 1990;31,  
1387–1398.

5. Öörni K, Pentikäinen MO,

Annala A and Kovanen P.

Oxidation of low density  
lipoprotein particles decreases  
their ability to bind to  
human aortic proteoglycans.

Dependence on oxidative  
modification of the lysine  
residues.

J. Biol. Chem. 1997;272,  
21303–21311.

6. Bartold PM and Page RC .

A microdetermination method  
for assaying glycosaminoglycans  
and proteoglycans.

Anal. Biochem. 1985;150,  
320–324.

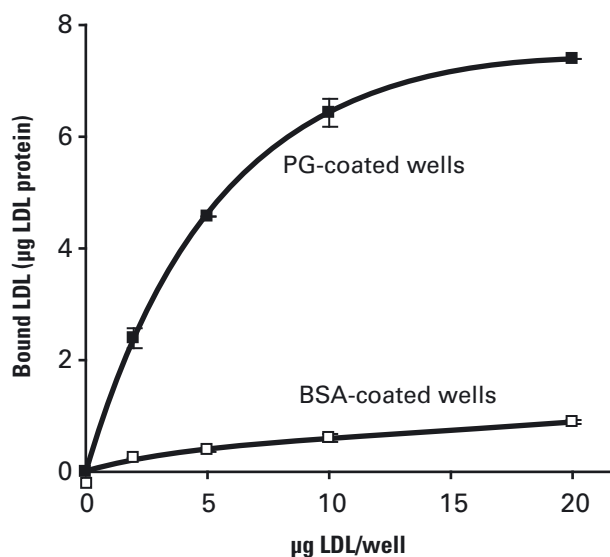
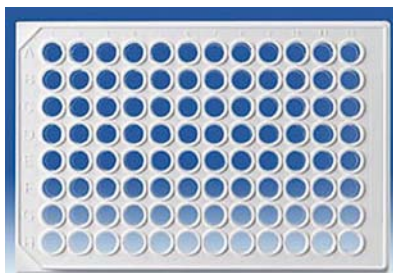


Fig.1. Saturation curves of native LDL in proteoglycan (PG)- and BSA-coated wells.

# Chemi-luminescent Alkaline Phosphatase Detection in White Clear Bottom Microplates

Monica Kyyhkynen, M.Sc., Thermo Fisher Scientific



Thermo White Clear Bottom 96 Plate

## Introduction

BOLD APS 540 reagent is a ready-to-use formulation for the chemiluminescent detection of alkaline phosphatase enzyme in a microtiter plate or a cuvette. The reagent produces a luminescent signal that increases in intensity for a period of at least two hours when exposed to alkaline phosphatase enzyme. For luminescent reactions, when performed in microplates, opaque white plates are normally used. We wanted to show whether the white clear bottomed microplates could be applied to the determination.

## Experimental

The Alkaline Phosphatase preparation used for the assay was Phosphatase, Alkaline from Bovine Calf; Sigma-Aldrich P7923-2KU, containing 23mg of protein and 4391 U/mg of protein. A suitable enzyme dilution ( $5 \times 10^{-5}$  U/well) was prepared and after adding the substrate the kinetic reaction producing chemiluminescent signal was monitored for a period of two hours. The curve achieved is shown in Fig. 1.

The test was repeated in a reference plate, a white opaque microplate (Thermo Scientific White Microtiter 96 Well Plate Universal Binding) to be able to compare the signals obtained in both the clear bottom plate and the opaque one. As expected, the signal obtained in the opaque white plate was somewhat higher than that produced in the white clear bottom plate, but the test seems to be well applicable to the latter one when needed (Fig. 2).

Signal versus background values for the plates were studied utilizing the BOLD APS 540 application.

Three different time points during the kinetic reaction were chosen and the signals detected at those points were compared to the background luminescence level. The corresponding background luminescence for the plates was measured in a luminometer. Thus obtained signal versus background values were calculated and are illustrated in Fig. 3. Different dilutions of the enzyme were prepared and the one giving the best kinetic curve with signal high enough and yet in a measurable range was chosen. The amount of the enzyme preparation used was  $5 \times 10^{-5}$  U per well.

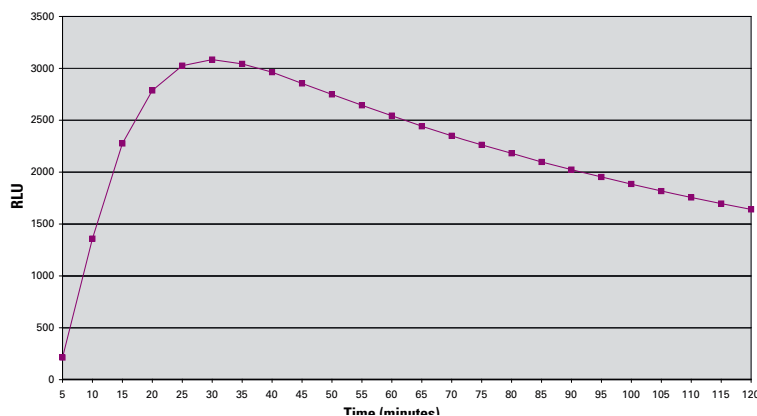


Fig. 1: Kinetics of enzyme reaction monitored in white clear bottom plate,  $5 \times 10^{-5}$  U of ALP per well

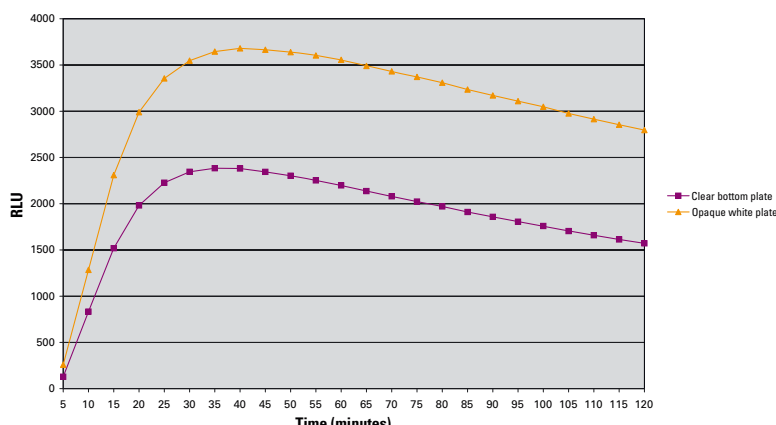


Fig. 2: Enzyme kinetics in white clear bottom plate compared to opaque white plate,  $5 \times 10^{-5}$  U of ALP per well

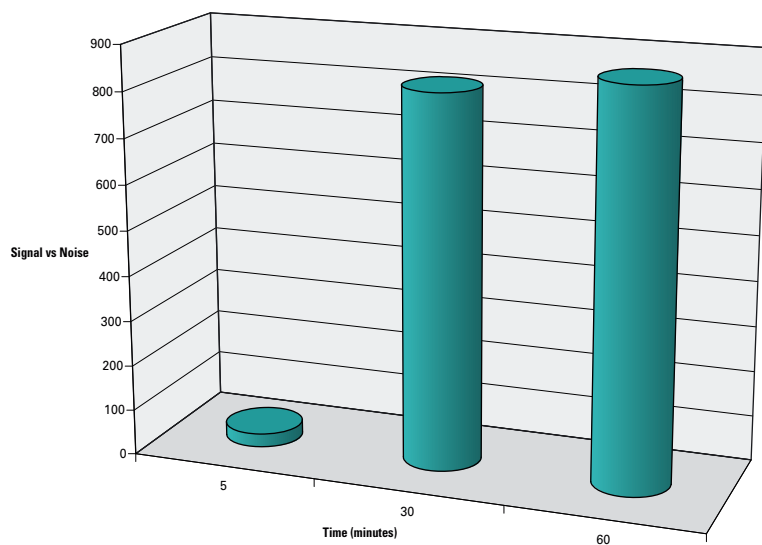


Fig. 3: Signal versus background values detected at different time points during kinetic enzyme reaction

### Discussion

The kinetic Alkaline Phosphatase determination BOLD APS 540 used in the experiment seems to be well applicable to the white clear bottomed microplates. Thus for example for applications where microscopic viewing through the bottoms of the wells needs to be combined with luminometric detection, these microplates offer a great choice.

[www.thermoscientific.com](http://www.thermoscientific.com)

©2011 Thermo Fisher Scientific Inc. All rights reserved. "BOLD APS" is a registered trademark of Intergen Company. All other trademarks are the property of Thermo Fisher Scientific Inc. and its subsidiaries.

# Fluorometric Protein Quantitation In Black Microplates

Irmgard Suominen, Thermo Fisher Scientific



This application note describes the suitability of Thermo Scientific black and black clear bottom microplates for fluorometric protein quantitation. The measurements were performed with Thermo Scientific Fluoroskan Ascent and reagents from a commercial available kit.

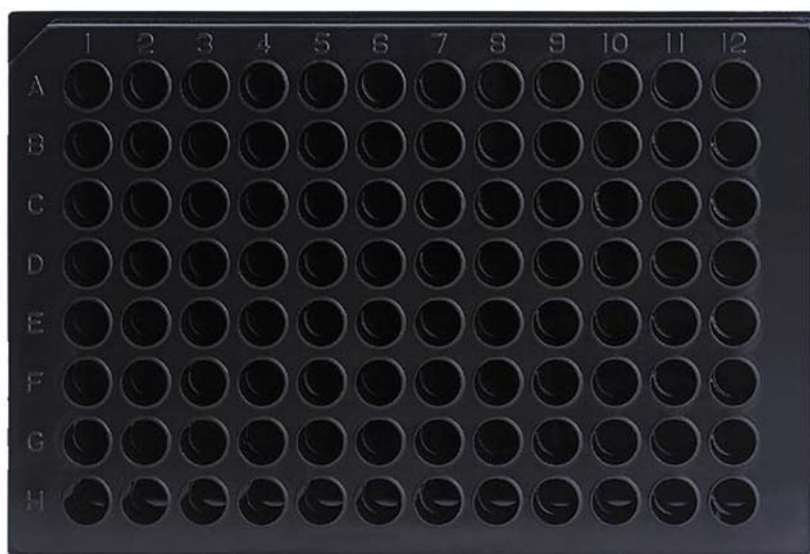
## Introduction

Quantitation of proteins is a common analysis in a wide variety of biological applications. There are several commercial kits available for this purpose. In this application note we used Quant-iT Protein Assay Kit. The Quant-iT protein reagent is fluorescent when bound to a protein. To determine the concentration of a protein the fluorescence can be compared to a standard curve.

We tested the suitability of Thermo Scientific universal binding black 96 well plate and black clear bottom 96 well plate (tissue culture treated) for use with this kit. Also competitor's black universal binding plates were included in the testing.

## Experimental

The assay was performed according to the manufacturer's instructions for use with the bovine serum albumin (BSA) standards that were included in the kit. The concentrations ranged from 0 to 500ng  $\mu\text{L}^{-1}$ , which represented 0 to 5 $\mu\text{g well}^{-1}$ . The fluorescence was measured using Thermo Scientific Fluoroskan Ascent with filter pair excitation 485nm and emission 584nm. The background fluorescence of the plates was measured in a similar way.



**Results and discussion**

The measured fluorescence intensity was plotted against the BSA mass ( $\mu\text{g}$ ) (Fig. 1). The obtained standard curve had a sigmoidal shape. The standard curve was similar for all used microtiter plates. This indicates that all plates were suitable for use with Quant-iT Protein Assay Kit.

The signal to noise ratio of the measured fluorescence was calculated for Thermo Scientific black plates and black clear bottom plates. The results are shown for 1, 3 and 5  $\mu\text{g}$  BSA (Fig. 2). The ratio varied from 4 to 32 for Thermo Scientific black clear bottom plates and from 8 to 69 for Thermo Scientific black

plates. This illustrates that the black plate gave higher signals than the clear bottom plates. The clear bottom plates, however, are a good choice when combining protein quantitation with direct microscopic observation.

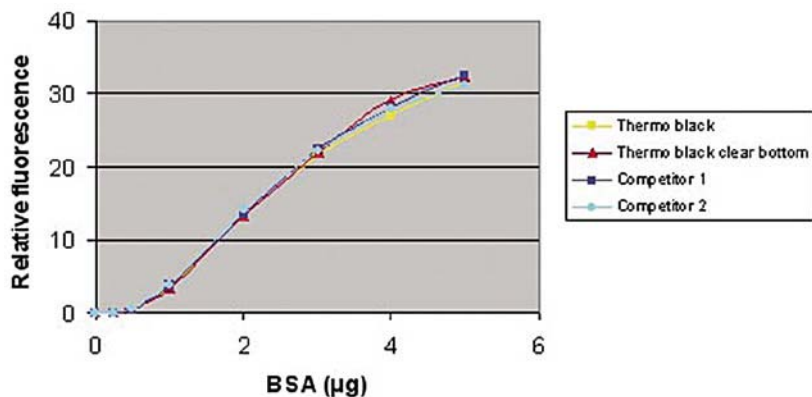


Fig. 1. BSA standard curve with Quant-iT protein assay kit.

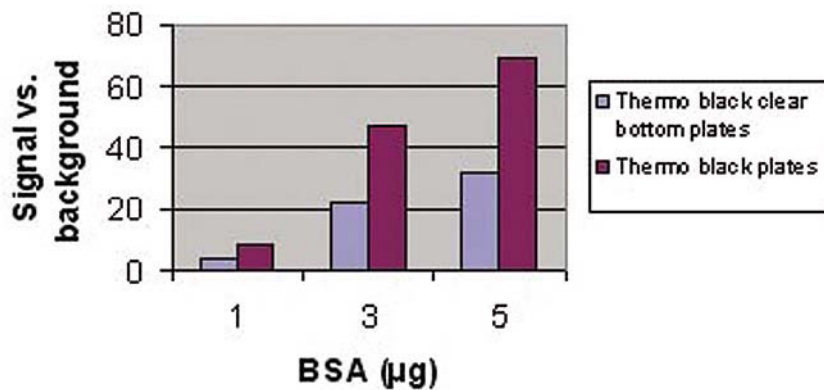


Fig. 2. Signal vs. background values for Thermo Scientific black and black clear bottom plates for three different BSA quantities.

www.thermoscientific.com

©2011 Thermo Fisher Scientific Inc. All rights reserved. "Quant-iT" is a registered trademark of Molecular Probes. All other trademarks are the property of Thermo Fisher Scientific Inc. and its subsidiaries.



# Multiserotype Enzyme-Linked Immunosorbent Assay using Thermo Scientific Microtiter Cliniplate

Pirkko Pussinen, Institute of Dentistry, Helsinki University, Finland  
Irmgard Suominen, Thermo Fisher Scientific



The aim of the study was to measure serum immunoglobulin G class antibodies against *Actinobacillus actinomycetemcomitans* and *Porphyromonas gingivalis* by an enzyme-linked immunosorbent assay (ELISA) in which mixtures of several serotypes of the pathogens were used as antigens to avoid biasing of the results in favor of a particular strain. Based on our results, we consider the serotype mixture ELISA to be a suitable tool to assess the periodontal status from serum samples in epidemiological studies.

## Introduction

Periodontal diseases are characterized by inflammatory changes in the periodontium caused by bacterial infections. Inflammation may lead to destruction of the tooth-supporting tissues and eventually to tooth loss. The finding that periodontitis is a plausible risk factor for cardiovascular diseases, rheumatoid arthritis, and premature birth adds a new perspective to the importance of oral health. The increased bacterial burden in the inflamed periodontal pockets may often lead to the presence of oral bacteria and their components in the systemic circulation.

The aim of the study was to measure serum immunoglobulin G (IgG) class antibody responses against *A. actinomycetemcomitans* and *P. gingivalis* by an ELISA in which mixtures of several serotypes of the pathogens were used as antigens. The immunoassay was designed to be used as a serological marker of periodontitis in large epidemiological studies in which no clinical or radiographic information on the periodontal status of the subjects is available.

## Material and Methods

### Study subjects

Serum samples from 90 subjects were included in the study. Out of these, 35 samples were from patients with diagnosed periodontitis (referred to simply as “patients”). Ten samples were from controls with clinically healthy periodontal tissues (referred to as “healthy controls”) with no periodontal attachment loss. The third group comprised 45 samples from randomly selected apparently healthy volunteers (referred to herein as “random controls”) who worked at a research institute in Helsinki, Finland.

### ELISA assay

Serum IgG antibodies against *A. actinomycetemcomitans* and *P. gingivalis* were determined by an ELISA using mixtures of six strains

of *A. actinomycetemcomitans* and three strains of *P. gingivalis* as antigens. The strains were ATCC 29523, ATCC 43718, ATCC 33384, IDH 781, IDH 1705, and C59A for *A. actinomycetemcomitans*, representing serotypes a, b, c, d, and e and one nonserotypeable (x) strain, and ATCC 33277, W50, and OMGS 434 for *P. gingivalis*, representing serotypes a, b, and c, respectively.

*A. actinomycetemcomitans* strains were grown on supplemented Brucella agar plates (containing 5% horse blood, hemin [5µg/mL], vitamin K1 [100mg/mL], and Brucella agar) and incubated in an atmosphere of 5% CO<sub>2</sub> at 37°C for three days. The cultures were transferred into Todd-Hewitt broth (3% TH, 1% yeast extract), where they were further grown for two days (one day in 5mL and one day in 200mL) under the conditions mentioned above. After removing the broth by centrifugation at 5,500 × g at room temperature for 15 minutes, the bacteria were washed with phosphate-buffered saline (PBS) (10mm phosphate [pH 7.4], 150mm NaCl). *P. gingivalis* strains were cultured on supplemented Brucella agar plates anaerobically for five to six days. The purity of the cultures was checked by colony morphology and Gram staining.

All strains to be used as antigens in the ELISA were fixed in 0.5% formalin–PBS overnight at 4°C and washed three times with PBS<sup>1</sup>. The density of the bacterial suspensions in the antigen buffer (PBS, 0.5% bovine serum albumin, 0.05% Tween 20 surfactant) was adjusted to give an absorbance of 0.15 at 580nm. For serotype mixture ELISA, equal volumes of the six *A. actinomycetemcomitans* or three *P. gingivalis* strains were mixed and used to coat microtiter plates (Thermo Scientific Microtiter Cliniplate).

The unspecific binding was blocked by 5% bovine serum albumin in PBS at room temperature for 30 minutes. Four dilutions of the serum samples in duplicate were added on the plate and incubated for two hours at room temperature. The dilutions used were 1/500, 1/1,500, 1/4,500, and 1/13,500 for *A. actinomycetemcomitans* and 1/100, 1/400, 1/1,600, and 1/6,400 for *P. gingivalis*.

The bound antibodies were visualized using horseradish peroxidase-coupled goat anti-human IgG (Sigma) diluted 1/20,000 and measured spectrophotometrically at 492nm. Unspecific binding was monitored by blank wells which contained no sample, and four dilutions of a “low” (pool of core blood) and a “high” (a high-level responding) control serum in duplicate were measured on each plate. The IgG levels are expressed as the areas (square millimeters) under the dose-response curves (AUCs) of the test and reference sera as suggested earlier by Sedgwick et al.<sup>2</sup>.

## Results

In the multiserotype ELISA the inter-assay coefficients of variation (CV%) were 4.1 and 8.1, and the intra-assay reproducibility (SD) between duplicate assays was 0.20 and 0.15 for *A. actinomycetemcomitans* and *P. gingivalis*, respectively. The detection limits for *A. actinomycetemcomitans* and *P. gingivalis* were 0.53 and 0.65mm<sup>2</sup>, respectively. To analyze how individual serum

IgG levels differ in serotype-specific and serotype mixture ELISAs, serum samples were evaluated by both types of assays. As an example from these analyses, Fig. 1 shows the serum serotype-specific antibody levels to periodontal pathogens measured from a patient with periodontitis and culture-positive for both pathogens.

In the serotype mixture ELISA the IgG level (mean ± SD) of all patients with periodontitis (n = 35) against *A. actinomycetemcomitans* was 22.60 ± 9.94mm<sup>2</sup> (Fig. 2). The mean AUCs of healthy controls and random controls were 9.99 ± 3.92mm<sup>2</sup> and 16.85 ± 6.67mm<sup>2</sup>, respectively. When the titers of all patients were analyzed as one group, the results were significantly higher than those of healthy controls (P < 0.001) or random controls (P < 0.01). In the *P. gingivalis* ELISA the IgG level of all patients (mean ± SD) was 26.72 ± 11.13mm<sup>2</sup>, and those of random controls and healthy controls were 8.51 ± 4.23mm<sup>2</sup> and 6.90mm<sup>2</sup> ± 3.38, respectively. The patients had higher antibody levels than random controls (P < 0.001) and healthy controls (P < 0.001), which in turn did not differ significantly from each other (P = 0.21).

## Discussion

Like this study demonstrates, the serotype mixture ELISA distinguishes as positive also the subjects whose antibody response against only one serotype is clearly dominant. Therefore, serotype mixture ELISA helps to minimize the risk of false negative results which are easily obtained, if only one strain representing one serotype is used as an antigen. Despite of the low number of study subjects included, the mean serum antibody levels to both pathogens differed significantly between the periodontitis patients and periodontally healthy subjects.

To calculate the results obtained by the ELISA, we recruited an earlier-devised method, which is currently only seldom used<sup>2</sup>. Although serial dilutions are laborious, the AUC gives a result, which is linearly

proportional to the antibody concentration<sup>2</sup>. In this way the results are as reliable as possible without a proper affinity-purified standard antibody. By exploring dilution curves, one also gets an idea about the affinity of the antibodies measured, which vary individually.

By calculating the AUCs, even small differences in the antibody levels are found, because the scale ranges between 0.65 and about 55mm<sup>2</sup>.

In immunological analyses the most essential point is the choice of antigen. For both *A. actinomycetemcomitans* and *P. gingivalis*, several serotypes have now been designated, and the individual antibody response depends on the amount and virulence of the infecting strains. There is still some disagreement on the localization and immunodominant nature of the antigen for both these species, which justifies the use of whole cells as antigens in the assay.

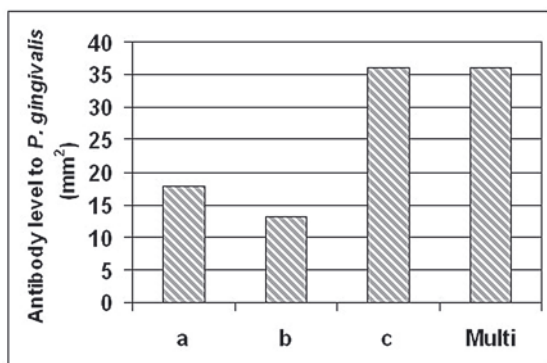
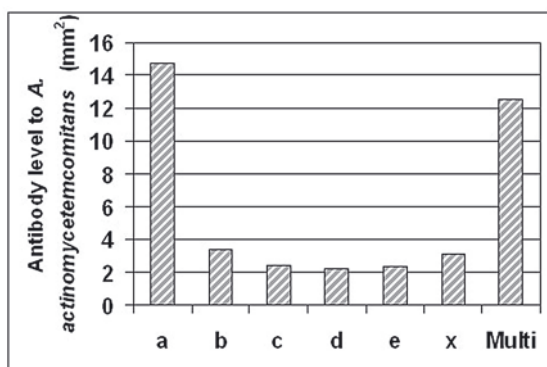
Based on our results, we consider the serotype mixture ELISA to be a suitable tool to assess the periodontal status from serum samples in epidemiological studies. The assay is particularly valuable in the study of the association between periodontal infections and systemic health.

## References

- Ebersole JL, Frey DE, Taubman MA and Smith DJ. An ELISA for measerum antibodies to *Actinobacillus actinomycetemcomitans*. *J. Periodontal Res.* 1980; 15:621-632.
- Sedgwick AK, Ballow M, Sparks K and Tilton RC. Rapid quantitative microenzyme-linked immunosorbent assay for tetanus antibodies. *J. Clin. Microbiol.* 1983; 18:104-109.

This application note is based on: Pussinen PJ, Vilkkuna-Rautiainen T, Alfthan G, Mattila K and Asikainen S. Multiserotype Enzyme-Linked Immunosorbent Assay as a diagnostic aid for periodontitis in large-scale studies. *J. Clin. Microbiol.* 2002; 40:512-518.

Published with kind permission of the American Society for Microbiology.

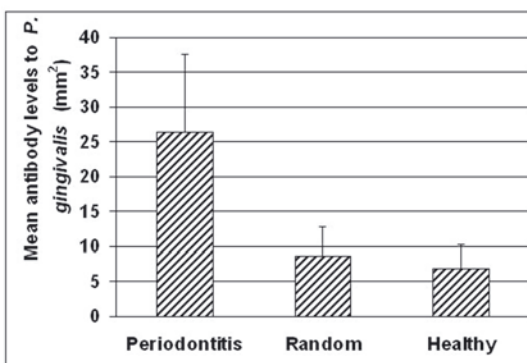
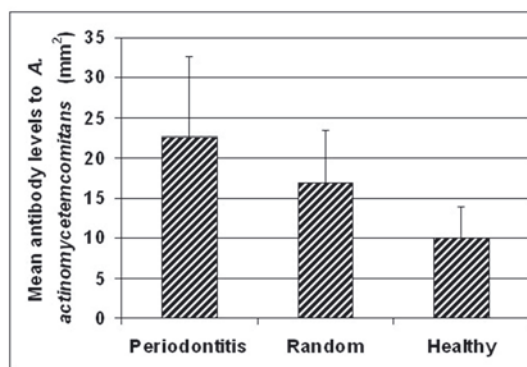


**Fig. 1.**

Serum serotype-specific antibody levels to periodontal pathogens. Serum IgG-class antibody levels to *Actinobacillus actinomycetemcomitans* and *Porphyromonas gingivalis* were measured from a patient with periodontitis and culture-positive for both pathogens. The antigens used in the assays were A) *A. actinomycetemcomitans* strains representing serotype, a, b, c, d, e, and a non-serotypeable strain (x) separately and in combination (Multi), and B) *P. gingivalis* strains representing serotypes a, b, and c separately and in combination (Multi).

www.thermoscientific.com

© 2011 Thermo Fisher Scientific Inc. All rights reserved. "Tween" is a registered trademark of Uniqema Americas. All other trademarks are the property of Thermo Fisher Scientific Inc. and its subsidiaries.



**Fig. 2.**

Mean antibody levels to periodontal pathogens as determined by multiserotype-ELISA. Serum samples were collected from 35 patients with clinically diagnosed periodontitis, 10 periodontally healthy subjects, and 45 randomly chosen volunteers. The IgG-class antibody levels to *A. actinomycetemcomitans* (A) and *P. gingivalis* (B) were determined by multiserotype-ELISA. Mean results and SD are shown, \*\*  $p < 0.01$ , \*\*\*  $p < 0.001$  between the groups indicated.

# Covalent Binding of DNA to Thermo Scientific Nunc CovaLink NH Methods and Applications

Søren Rasmussen, Senior Scientist, Thermo Fisher Scientific

DNA can be bound covalently to Thermo Scientific Nunc CovaLink NH strips. The DNA molecules are bound exclusively at the 5'-end by a phosphoramidate bond. Immobilization of more than 1 pmol is possible. When DNA coated Nunc™ CovaLink™ NH strips are used as the solid phase for hybridization assays, detection of less than  $15 \cdot 10^{-18}$  moles is possible.

## Introduction

Hybridization in Thermo Scientific Nunc MicroWell Plates is, due to their easy handling (multichannel pipettes, readers, and other instruments for ELISA techniques can be used), a very promising method for diagnostic purposes. Furthermore, MicroWell™ plates allow the use of non-radioactive probes.

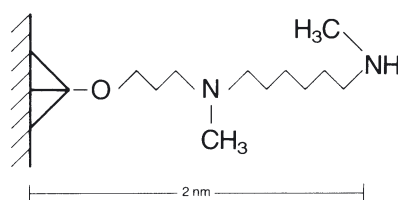
So far, the limitations of hybridization in MicroWell plates have been the immobilization of DNA on the surface of MicroWells. Immobilization can be obtained by passive adsorption<sup>1</sup>, by UV light<sup>2-4</sup>, or by covalent binding of base modified DNA molecules<sup>5-6</sup>. These methods present the same disadvantages as for immobilization of DNA on nitrocellulose: i.e. the molecules are bound more or less efficiently to the solid phase at several sites.

The ideal immobilization of DNA on a solid phase is done by one single covalent bond, preferably at either the 3'- or 5'-end.

The use of CovaLink NH strips for covalent binding of DNA molecules at only the 5'-end has

recently been described<sup>7</sup>. The DNA molecules were bound to CovaLink NH by a phosphoramidate bond<sup>8</sup>.

CovaLink NH, a novel type of MicroWell surface, has secondary amino groups positioned at the end of spacer arms covalently grafted to the polystyrene surface through a »handle« (MW 200) (Fig. 1).



**Fig. 1** The linker grafted onto CovaLink NH. The linker density is approximately  $10^{14}$  /  $\text{cm}^2$ .

How DNA is bound to CovaLink NH, and the results obtained using CovaLink NH strips with covalently bound DNA molecules as solid phase for hybridization assays are described here.

## Covalent binding of single stranded DNA (ssDNA) to CovaLink NH

Different types of DNA molecules have been used for binding (Fig. 2). All types were bound covalently to CovaLink Modules NH F8 (Cat. No. 478042).

It has been verified that the DNA molecules are bound exclusively at the 5'-end using non-phosphorylated oligonucleotides for binding<sup>7</sup>. Non-phosphorylated oligonucleotides lack the 5'-end phosphate group, so they cannot be bound to CovaLink NH by the desired phosphoramidate bond.

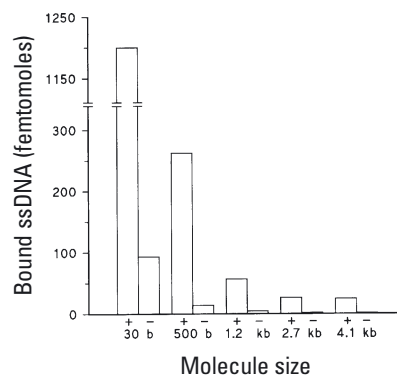
The use of non-phosphorylated oligonucleotides for binding reduced the amount of bound DNA molecules by 85%.

## Method

DNA dissolved in water (7.5 ng/ $\mu\text{L}$ ) was denatured for 10 min. at 95°C and cooled on ice (10 min.).

Ice-cold 0.1 M 1-methylimidazole pH 7.0 (1-MeIm<sub>7</sub>) was added to a final concentration of 10 mM 1-MeIm<sub>7</sub>. The ssDNA solution was dispensed into CovaLink NH strips (75  $\mu\text{L}$ /well) standing on ice.

Carbodiimide (0.2 M) 1-ethyl-3-(3-dimethylaminopropyl)-



**Fig. 2** Various types of DNA were used for binding. Oligonucleotide was phosphorylated with [ $\gamma$ -<sup>32</sup>P] ATP, and 3 x molar excess ATP.  $\lambda$  DNA was digested with HinfI, resulting in fragments of different sizes. The majority of the fragments were 350-500 bp. Different plasmid DNA were linearized with HindIII or BgII + HindIII resulting in fragments of 1.2, 2.7, and 4.1 kbp.  $\lambda$  and plasmid DNA were 3' labeled with [ $\alpha$ -<sup>32</sup>P] dATP and Klenow enzyme. After coupling, the CovaLink NH strips were dissolved in toluene and the amount of bound DNA molecules was measured by liquid scintillation. Binding was made with (+) or without (-) carbodiimide.

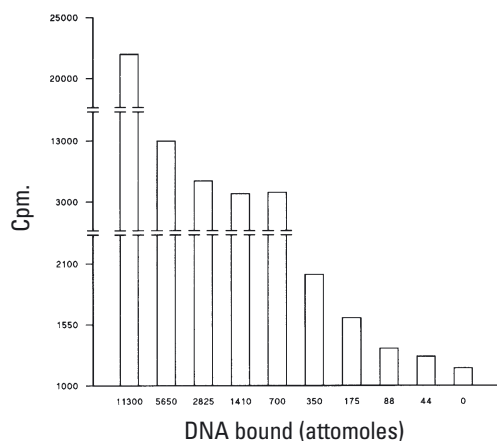
carbodiimide (EDC), dissolved in 10 mM 1-MeIm<sub>7</sub>, was made fresh for each experiment, 25  $\mu$ L was added per well. The strips were incubated for 5 hours at 50°C.

After incubation the strips were washed using Thermo Scientific Nunc Immuno Wash (e.g. Cat. No. 470174); first the wells were washed 3 times, then they were soaked with washing solution for 5 min., and finally they were washed 3 times. Washing solution: 0.4 N NaOH, 0.25% SDS heated to 50°C.

### Hybridization of DNA immobilized onto CovaLink NH

The DNA molecules are immobilized on CovaLink NH at only the 5'-end. They are therefore ideal for hybridization. To test this a simple 2-layer technique was used.

Target DNA (plasmid DNA, 3.2 kbp) was linearized and coupled to CovaLink NH using the method described above. Target DNA was 1:2 diluted with non-target DNA of the same size. By using these dilutions for binding to CovaLink NH, the target concentration could be gradually reduced while the DNA concentration was kept constant.



**Fig. 3**

Target DNA was 1:2 diluted with non-specific DNA of the same size. The DNA was bound to CovaLink NH as described. The modules were incubated overnight with hybridization buffer and

Labeled probe ( $10^{16}$  cpm.<sup>32</sup>P) was added to each well and hybridized overnight at 42°C.

Detection of  $44 \cdot 10^{-18}$  moles target DNA bound per well was possible (Fig. 3).

### Method

Prior to hybridization, the CovaLink NH strips were rinsed once with hybridization buffer (0.75 M NaCl, 5 mM sodium phosphate (pH 7.0), 5 mM EDTA, 0.1% Tween 20, 50% formamide, and 100  $\mu$ g/mL sheared and denatured herring sperm DNA).

The strips were incubated overnight at 42°C in 100  $\mu$ L hybridization buffer containing  $10^6$  cpm. probe per well. After incubation the strips were washed 3 times for 20 min. with 6 x SSC, 0.1% SDS at 60°C.

The wells were dissolved in toluene and the amount of hybridized probe was measured by liquid scintillation.

### 3-layer sandwich hybridization

CovaLink NH strips have been used for 3-layer sandwich hybridization. The strips were coated with capture probe (oligonucleotide, 30 b) and hybridized overnight with 1:2

dilutions of denatured target (plasmid DNA, 3.2 kb) and detection probe (biotinylated oligonucleotide, 30 b). Detection of the hybridization complex was done by addition of a fluorescent substrate.

With this method detection of less than  $15 \cdot 10^{-18}$  moles of target DNA per well was possible (Fig. 4). Control hybridizations with  $2 \cdot 10^{-15}$  moles of non-target DNA were performed (dotted line in Fig. 4).

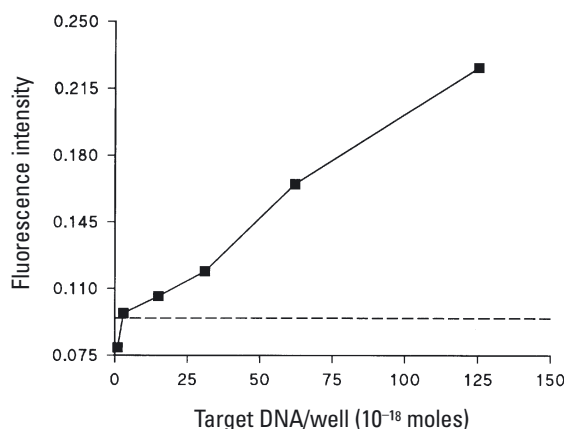
### Method

Approx. 10 ng capture probe was bound per well. After binding of capture probe, the strips were rinsed once with hybridization buffer (6 x SSC, 5 x Denhardt, 100  $\mu$ g/mL herring sperm DNA).

Hybridization was performed overnight at 45°C in 150  $\mu$ L/well hybridization buffer with 1:2 dilutions of linearized target and  $5 \cdot 10^{-15}$  moles/well detection probe.

After hybridization the plates were washed 3 x 20 minutes at 37°C, once with 2 x SSC, 0.1% Tween 20, and twice with 0.1 x SSC, 0.1% Tween 20.

After washing the strips were incubated with SA-AP conjugate, and 4-MUP was used as substrate.



**Fig. 4**

Sensitivity obtained with 3-layer sandwich hybridization in CovaLink Modules. Approx. 10 ng capture probe was bound per well. Target DNA was added as 1:2 dilutions with biotinylated

## Conclusion

DNA can be covalently bound to CovaLink NH strips almost exclusively by the 5'-end, which makes the use of CovaLink NH strips coated with DNA molecules very suitable for hybridization assays. The results with 3-layer sandwich hybridizations show detection of less than  $15 \cdot 10^{-18}$  moles of DNA.

CovaLink NH strips have the format of MicroWell plates and can therefore be used in all known ELISA instruments, thus assuring easy handling and allowing the possibility of automation.

The combination of good hybridization results with the MicroWell plate format makes the CovaLink NH strip a very promising candidate for solid phase in DNA diagnostic assays.

## References

1. Inouye S and Hondo R  
Microplate hybridization of amplified viral DNA segment.  
J. Clin. Microbiol. 1990, 28:1469-1472.
2. Nagata Y, Yokota H, Kosuda O, Yokoo K, Takemura K, Kikuchi T  
Quantification of picogram levels of specific DNA immobilized in microtiter wells.  
FEBS Lett 1985, 183 2:379-382.
3. Dahlén P, Syvänen AC, Hurskainen P, Kwiatkowski M, Sund C, Ylikoski J, Söderlund H, Lövgren T.  
Sensitive detection of genes by sandwich hybridization and time-resolved fluorometry.  
Mol Cell Probes. 1987, 1:159-168.
4. Morrissey DV and Collins ML.  
Nucleic acid hybridization assays employing dA-tailed capture probes. Single capture methods.  
Mol Cell Probes. 1989, 3:189-207.
5. Keller GH, Cumming CU, Huang DP, Manak MM and Ting R.  
A chemical method for introducing haptens onto DNA probes.  
Anal Biochem. 1988, 170:441-450.
6. Keller GH, Huang DP and Manak MM.  
A sensitive nonisotopic hybridization assay for HIV-1 DNA.  
Anal Biochem. 1989, 177:27-32.
7. Rasmussen SR, Larsen MR and Rasmussen SE.  
Covalent immobilization of DNA onto polystyrene microwells: the molecules are only bound at the 5' end.  
Anal Biochem. 1991, 198:138-142.
8. Chu BC, Wahl GM and Orgel LE.  
Derivatization of unprotected polynucleotides.  
Nucleic Acids Res. 1983, 11:6513-6529.

[www.thermoscientific.com/oemdiagnostics](http://www.thermoscientific.com/oemdiagnostics)

©2010 Thermo Fisher Scientific Inc. All rights reserved. "Tween" is a registered trademark of Uniqema Americas. All other trademarks are the property of Thermo Fisher Scientific Inc. and its subsidiaries.

# Coupling of Oligosaccharides to Thermo Scientific Nunc CovaLink NH Modules

This Tech Note describes the use of oligosaccharides in monostructured solid phase recognition studies where the oligosaccharide is covalently immobilized on Thermo Scientific Nunc CovaLink NH Modules.

The interest in carbohydrates has increased. One of the main reasons for this is due to the results obtained through research in cell communication, e.g. between leucocytes and in bacterial adhesion.

From that point of view carbohydrates are remarkable information molecules compared to peptides and nucleotides.

If, for instance, two identical monosaccharides are combined, 11 different disaccharides can be built. Whereas, if two identical

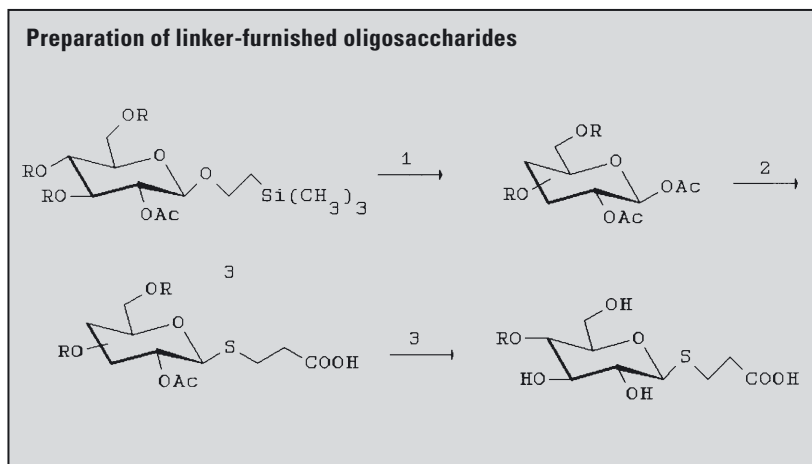
aminoacids are combined, only one dipeptide can be formed, and with four different monosaccharides 35,560 unique tetrasaccharides can be created. It is no wonder then that carbohydrates by nature have been assigned a role in communication within living creatures <sup>1,2</sup>.

The diversity of polysaccharides has, however, been a problem in the search for biologically relevant carbohydrate structures for use in the struggle against infection and cancer. Not only is it difficult to collect enough material for examination, it has also been difficult to perform carbohydrate chemistry.

However, synthetically made oligosaccharides have become a potential tool in the search for active structures. The technology

now has evolved to a level comparable to that employed in peptide and nucleotide synthesis, hence a wide range of synthetic saccharides are now commercially available.

## Synthesis of oligosaccharide utilizing the 2-(Tri-methylsilyl)-ethyl (TMSEt) group for anomeric protection.

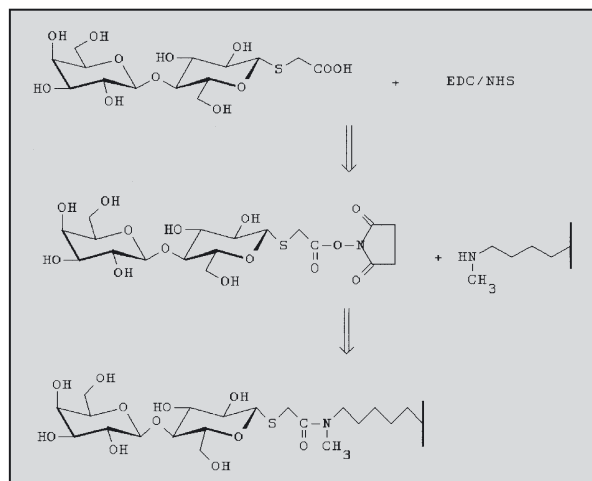


R = acryl group or »protected« sugar residues

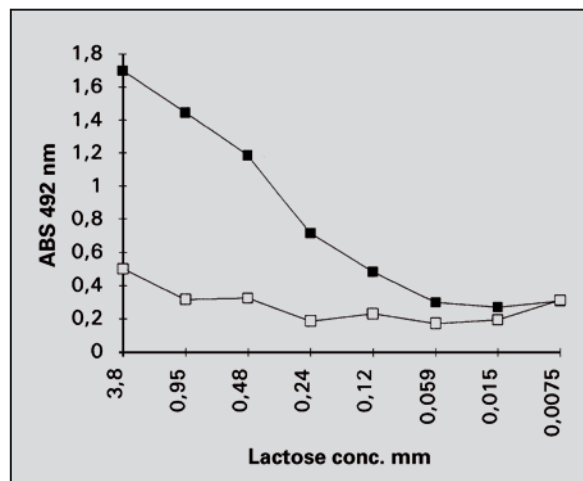
A = acetyl group

- 1) Typically 3 equivalents of acetic anhydride and 1.1 equivalents of boron trifluoride-etherate in chloroform or toluene at room temperature for 1 hour. Purification by column chromatography <sup>3</sup>.
- 2) Mercaptopropionic acid (2.5-3 equivalents) and boron trifluoride-etherate (1.2 equivalents) in methylene chloride at 0°C <sup>4</sup>. Purification by column chromatography.
- 3) Deacetylation using sodium methoxide in methanol. Neutralization and chromatographic purification normally produces the deblocked sugar in quantitative yield.

## Coupling to CovaLink NH



## Binding of activated lactose on CovaLink NH



**Coupling of sugar to Nunc™ CovaLink™ NH and detection of binding exemplified by the Erythrina coralloidendron – lactose interaction** <sup>5</sup>. Lactose activated (A-Lac) according to the method described above was used:

- 1) A 1:2 dilution of A-Lac was made in CovaLink NH wells. 100  $\mu$ L 7.8 mm A-Lac in H<sub>2</sub>O were added to wells in column 1. 50  $\mu$ L H<sub>2</sub>O were added to the rest of the wells, 50  $\mu$ L were transferred from column 1 to column 2, etc. After mixing, 50  $\mu$ L were disposed of from column 12. Finally NHS/EDC in aqueous solution (25  $\mu$ g each/well) was added to all wells (50  $\mu$ L/well).
- 2) The plate was incubated on shaker at RT for 1.5 hour.
- 3) Blocked using PBS + 0.5% BSA overnight at 4°C (200  $\mu$ L/well).
- 4) Rinsed with PBS + 0.5% BSA + 0.05% Triton X-100, 3 times 200  $\mu$ L/well.
- 5) Biotinylated *Erythrina coralloidendron* (10  $\mu$ g/mL PBS + 0.5% BSA) corresponding to 0.36  $\mu$ m regarding binding sites (100  $\mu$ L/well).
- 6) Incubated for 2 hours at RT.
- 7) Rinsed using CovaBuffer (PBS + 2 M NaCl + 65 mm MgSO<sub>4</sub>·2 H<sub>2</sub>O + 0.05% Tween 20) 3 times 200  $\mu$ L/well.
- 8) Horseradish peroxidase conjugated Avidine added (1:1000 v/v in PBS + 0.5% BSA) (100  $\mu$ L/well).
- 9) Incubated for 1 hour at RT.
- 10) Rinsed using CovaBuffer 3 times 200  $\mu$ L/well.
- 11) Substrate (H<sub>2</sub>O<sub>2</sub>, OPD; 100  $\mu$ L/well) 5 min. at RT; the reaction stopped by adding 1M H<sub>2</sub>SO<sub>4</sub> (100  $\mu$ L/well).
- 12) The results read at 492 nm.

## References

- 1: Nathan Sharon and Halina Lis. Carbohydrates in Cell Recognition. Scientific American, January 1993, 74-81.
- 2: Nathan Sharon and Halina Lis. Lectins as Cell Recognition Molecules. Science, 246, (1989), 227-234.
- 3: Karl Jansson, Stefan Ahlfors, Torbjörn Frejd, Jan Kihlberg, Göran Magnusson, Jan Dahmén, Ghazi Noori and Kristina Stenvall. 2-(Trimethylsilyl)ethyl Glycosides. 3. Synthesis, Anomeric Deblocking, and Transformation into 1,2-trans 1-O-acyl Sugars. J. Org. Chem., 53, (1988), 5629-5647.
- 4: Mikael Elofsson, Björn Walse and Jan Kihlberg. Building Blocks for Glycopeptide Synthesis: Glycosylation of 3-Mercaptopropionic Acid and Fmoc Amino Acids with Unprotected Carboxyl Groups. Tetrahedron Lett., 32, (1991) 7613-7616.
- 5: N. Gilboa-Garber and L. Mizrahi. A New Mitogenic D-galactosephilic Lectin Isolated from Seeds of the Coral-tree *Erythrina Coralloidendron*. Comparison with Glycine Max (Soybean) and *Pseudomonas Aeruginosa* Lectins. Can. J. Biochem., 59, (1981) 315-320.

## Acknowledgement:

This Tech Note is based on work done by Tomas Ekberg, M.Sc., Organic Chemistry 2, Lund Institute of Technology, University of Lund, Sweden.

www.thermoscientific.com/oemdiagnostics

© 2010 Thermo Fisher Scientific Inc. All rights reserved. "Triton" is a registered trademark of Dow Chemical Company, and "Tween" is a registered trademark of Uniqema Americas. All other trademarks are the property of Thermo Fisher Scientific Inc. and its subsidiaries.

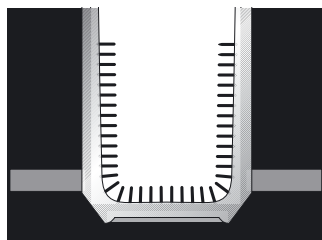


# DIAPOPS using Thermo Scientific Nunc CovaLink BreakApart Modules

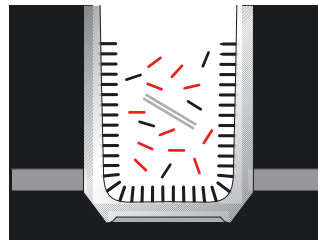
Polymerase Chain Reaction (PCR) has had a major influence on molecular biology and the development of molecular diagnostics. Despite the opportunities offered by PCR, the method has certain limitations. PCR can amplify DNA molecules a thousandfold, but the presence or absence of amplicons must be verified by other methods such as gel electrophoresis, Southern blotting, and various hybridization techniques.

The necessity of characterization of the amplicons by other methods means time-consuming transfer. Also during transfer of the amplicons, laboratory contamination with trace amounts of amplicon might occur, wreaking havoc on subsequent amplifications. To reduce the possibility of contamination, techniques involving handling of DNA samples and amplicons in different rooms <sup>1</sup>, or using urasil DNA glycosidase to degrade contaminants <sup>2</sup>, have been used.

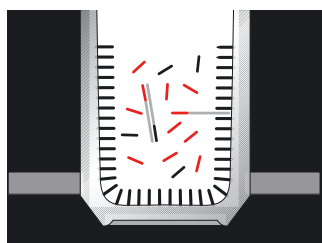
## Principle of DIAPOPS



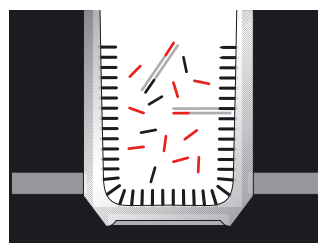
1. One primer is bound covalently at only the 5' end to the surface of a well. Either of the two primers can be used for binding. The choice between the upstream and the downstream primer depends on the oligonucleotide available as detection probe; the primer used for binding and the detection probe must be from opposite strands.



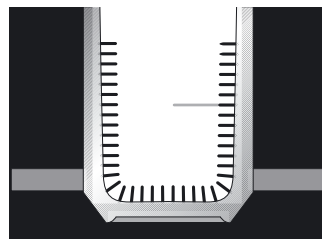
2. Buffer, dNTP's, Taq DNA polymerase, template and primers are added to a well containing the covalently bound primer. The amplification is semi-asymmetric since the relation between the bound and the unbound primer is 1:8.



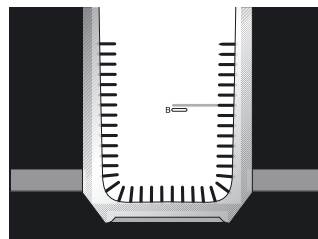
3. Amplification is initiated in the liquid phase. After approximately cycle 20, more and more amplicon will hybridize with the bound primer. These primers will be extended by the Taq polymerase.



4. After amplification, the well contains two types of amplicon: amplicon in the liquid phase, and amplicon bound to the solid phase at one single point.



5. Amplicon in the liquid phase is removed by washing. The bound amplicon is converted to single stranded molecules by treatment with 0.2 N NaOH.



6. The single stranded molecules are detected by hybridizing with a detection probe. We used a biotinylated detection probe, but any type of detection probe can be used.

We have developed a new technique utilizing Thermo Scientific Nunc CovaLink BreakApart Modules. This technique, named DIAPOPS (Detection of Immobilized, Amplified Product in a One Phase System) integrates amplification and subsequent characterization<sup>3</sup>. The complete assay takes place in the same well.

DIAPOPS simplifies manipulations and reduces contamination, since no transfer of amplicon is needed. Here we describe DIAPOPS for detection of bovine leukemia virus (BLV).

#### Covalent binding of primer at the 5' end to Nunc™ CovaLink™ BreakApart™ Modules

To each well in a CovaLink BreakApart Module, 100 ng primer dissolved in 75  $\mu\text{L}$  13 mm 1-methyl-imidazole pH 7.0 is added. Then 25  $\mu\text{L}$  freshly made 40 mm 1-Ethyl-3-(3-Dimethylaminopropyl) carbodiimide (EDC) is added, and the strips are incubated at 50°C for 5 hours. The total volume is 100  $\mu\text{L}$  and the final concentrations per well are 100 ng primer, 10 mm 1-methyl-imidazole and 10 mm EDC.

The use of 50 mm EDC for covalent binding of oligonucleotides to CovaLink NH Modules is described in the literature<sup>4</sup>. However, the use of 10 mm EDC during coating gives a better sensitivity for the DIAPOPS procedure.

After incubation the strips are washed at 50°C with 0.4 N NaOH, 0.25% Tween 20 using the Thermo Scientific Nunc Immuno Wash. First the strips are washed three times, then soaked for 5 minutes, and finally washed three times. Remaining wash buffer is removed by rinsing the strips once with deionized water.

The coated strips contain approximately 1 pmol covalently bound primer per well. The coated strips can be stored dry in a refrigerator for at least one year.

#### DIAPOPS

##### Amplification

5  $\mu\text{L}$  template DNA ( $5 \times 10^{-23}$ - $5 \times 10^{-16}$  mol BLV) was mixed with 45  $\mu\text{L}$  PCR buffer (10 mm Tris-HCl (pH 8.3), 50 mm KCl, 1.8 mm MgCl<sub>2</sub>, 0.015% gelatin, 0.1% Tween 20), 200  $\mu\text{m}$  of each dNTP, 1 U Taq DNA polymerase, 0.5  $\mu\text{m}$  upstream primer and 0.06  $\mu\text{m}$  downstream primer (the downstream primer is also used for binding to the strips) and applied to each well of a coated strip. Evaporation was prevented by mineral oil.

##### Thermocycling

Cycle 1: 92°C for 5 seconds, 58°C for 1 second. Cycle 2-35: 91°C for 5 seconds, 58°C for 1 second. The fastest ramp time was used.

Since CovaLink BreakApart Modules are manufactured of polystyrene, they are heat labile. It is therefore important, especially during denaturations, to keep the cycling time as short as possible.

We used the MicroWell PlateCycler from Coy (Grass Lake, MI, USA).

This thermal cycler has two temperature probes, one monitors the temperature in the heating block, the other mimics the temperature in the samples (sample probe).

During heating and cooling, the temperature profiles in the sample probe and the samples are not absolutely identical. However, the sample probe allows fast and efficient optimization of the amplification conditions.

Any thermocycler accepting 0.5 mL amplification tubes can be used. Break the strips apart and incubate the individual wells in the heating block. Oil may be applied to the heating block for a better heat transmission. After amplification, the wells can be replaced in the carrier and manipulated as a strip. However, when thermal cyclers other than the MicroWell PlateCycler are used, a less perfect fit must be expected. Therefore, the amplification procedures must be optimized for the particular thermal cycler accomplished. The optimization is most easily done by performing normal PCR in uncoated CovaLink BreakApart Modules and evaluating the amplicons by gel electrophoresis.

After amplification the strips are washed with 0.2 N NaOH utilizing the Immuno™ Wash. The strips are washed 3 times, then soaked for 5 minutes, and finally washed three times. After washing, the strips are rinsed once with hybridization buffer.

#### Hybridization and detection with fluorogenic substrate

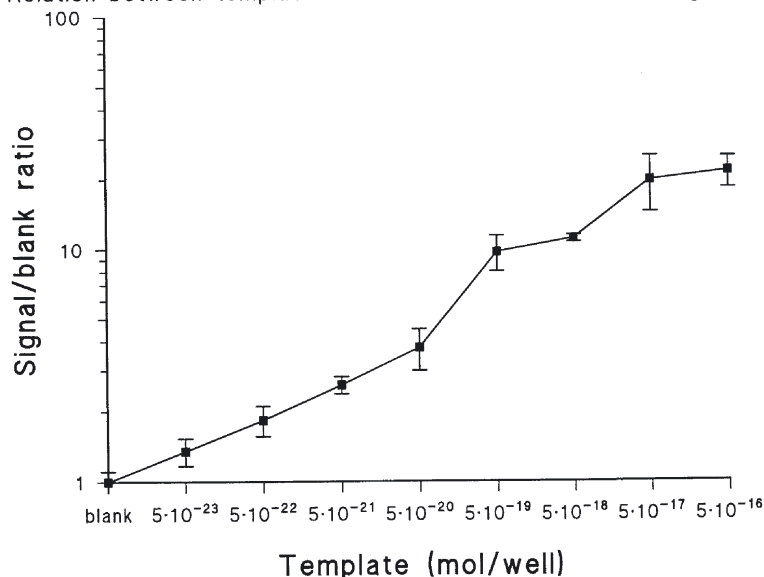
Hybridization was performed overnight with 0.1 nm biotinylated detection probe at 45°C in 100  $\mu\text{L}$  hybridization buffer (2 X SSC, 5 X Denhardt's solution). After hybridization the strips are washed with 0.1 X SSC, 0.1% Tween 20.

The strips are washed three times, then soaked at 37°C for 10 minutes, and finally washed three times.

100  $\mu$ L diluted streptavidin alkaline phosphatase conjugate is added to each well, and the strips are incubated at 20°C for one hour. The streptavidin alkaline phosphatase conjugate is diluted 1:3000 with PBS, 0.05% Tween 20. After incubation, the strips are washed with PBS, 0.05% Tween 20 at 20°C as described above.

Finally, the strips are incubated at 37°C with 200  $\mu$ L 1 mM 4-methylumbelliferyl phosphate in 1 M diethanolamine (pH 9.8), 1 mM MgCl<sub>2</sub> for 30 minutes. The strips are read on a fluorescence plate reader: excitation wavelength 360 nm, emission wavelength 450 nm.

Relation between template concentrations and DIAPOPS signals



## References

1. Kwok S, Higuchi R. Avoiding false positives with PCR. *Nature*, 1989, 339:237-238.
2. Longo MC, Beringer MS, Hartley JL. *Gene*, 1990, 93:125-128.
3. Rasmussen SR, Rasmussen HB, Larsen MR, Hoff-Jørgensen R, Cano RJ. Combined polymerase chain reaction-hybridization microplate assay used to detect bovine leukemia virus and Salmonella. *Clinical Chemistry*, 1993, 40/2:200-205.
4. Rasmussen SR, Larsen MR, Rasmussen SE. Covalent immobilization of DNA onto polystyrene microwells: The molecules are only bound at the 5' end. *Analytical Biochemistry*, 1991, 198:138-142.

[www.thermoscientific.com/oemdiagnostics](http://www.thermoscientific.com/oemdiagnostics)

© 2011 Thermo Fisher Scientific Inc. All rights reserved. "Tween" is a registered trademark of Uniqema Americas, and "MicroWell PlateCycler" is trademark of Coy, USA. All other trademarks are the property of Thermo Fisher Scientific Inc. and its subsidiaries.

# Thermo Scientific Nunc NucleoLink versus CovaLink Surfaces

When performing ELISA-like procedures with nucleic acids in Thermo Scientific Nunc MicroWell plates, the adsorption of nucleic acid molecules to the plastic surface is one factor which distinguishes success from failure.

We provide two types of surfaces for covalent immobilisation of nucleic acids: Thermo Scientific Nunc CovaLink and NucleoLink.

By a process, the Nunc™ CovaLink™ surface is grafted covalently to the polymer surface with a linker molecule ending in a secondary amino group. Nucleic acid molecules are bound at only the 5'-end to this linker molecule by carbodiimide condensation.

The NucleoLink™ surface binds nucleic acids by carbodiimide condensation using a procedure similar to CovaLink. NucleoLink binds more nucleic acids than CovaLink, and more importantly, the NucleoLink surface is heat stable at temperatures up to 120°C. Combined with the thin wall (0.35 mm) this makes NucleoLink highly suitable for solid phase PCR.

## Binding of oligonucleotide to NucleoLink and CovaLink

Various concentrations of <sup>32</sup>P labeled oligonucleotide (0.133 ng/μL; 0.266 ng/μL; 0.4 ng/μL; 13.33 ng/μL) in 10 mm 1-methyl imidazole were pipetted into NucleoLink or CovaLink Strips, 75 μL/well. 25 μL freshly made

40 mm (EDC) in 10 mm 1-methyl imidazole was added to each well containing oligonucleotide. The CovaLink and NucleoLink Strips were then sealed and incubated at 50°C for five hours.

After incubation the strips were washed with 0.4 N NaOH, 0.25% Tween 20 using a Thermo Scientific Nunc Immuno Washer. The strips were washed three times, incubated at 50°C for 15 minutes and finally re-washed three times. The amount of covalently bound DNA was measured by liquid scintillation.

## Conclusion

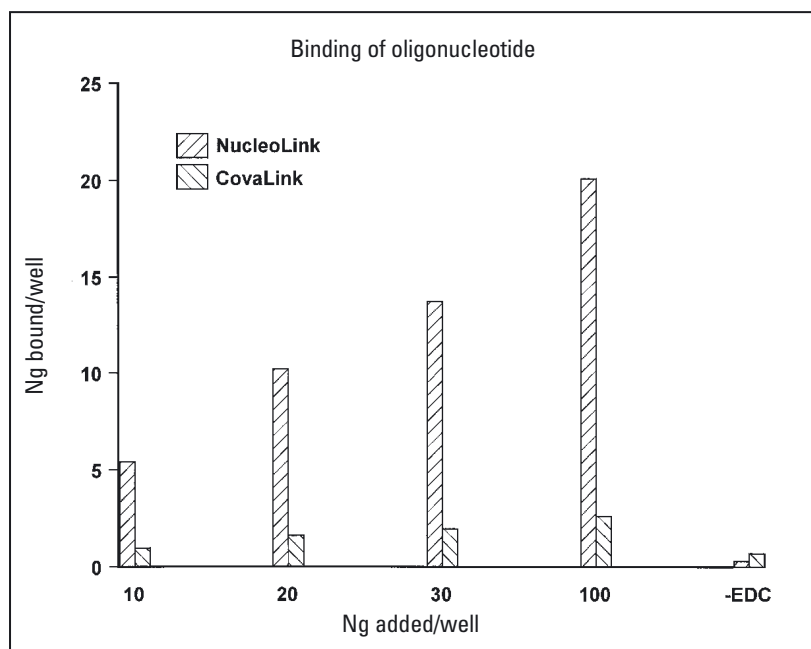
20% to 50% of the oligonucleotide present during coating is bound to NucleoLink.

## NucleoLink and CovaLink used for DIAPOPS

Six reaction mixtures were prepared. To four of the mixtures 5 μL from four different known positive BLV (Bovine Leukemia virus) samples were added. To the two remaining reaction mixtures 5 μL water were added. One half of each reaction mixture was added to a NucleoLink Strip, the other half to a CovaLink Strip. After amplification, hybridization and incubation with substrate, the fluorescence intensity was measured.

## Fig. 1.

The amount of oligonucleotide (10, 20, 30, and 100 ng/well) present during coating. Non-specific adsorption was tested by adding 100 ng oligonucleotide/well without EDC.



**Conclusion**

The fluorescence intensities obtained from the positive samples in NucleoLink Strips are approximately 4 times greater than the values from the same samples in CovaLink Strips (Fig. 2). Furthermore, the fluorescence intensities obtained from negative samples in either strips are identical. Therefore, the use of NucleoLink for solid phase PCR assays greatly enhances the distinction between positive and negative samples.

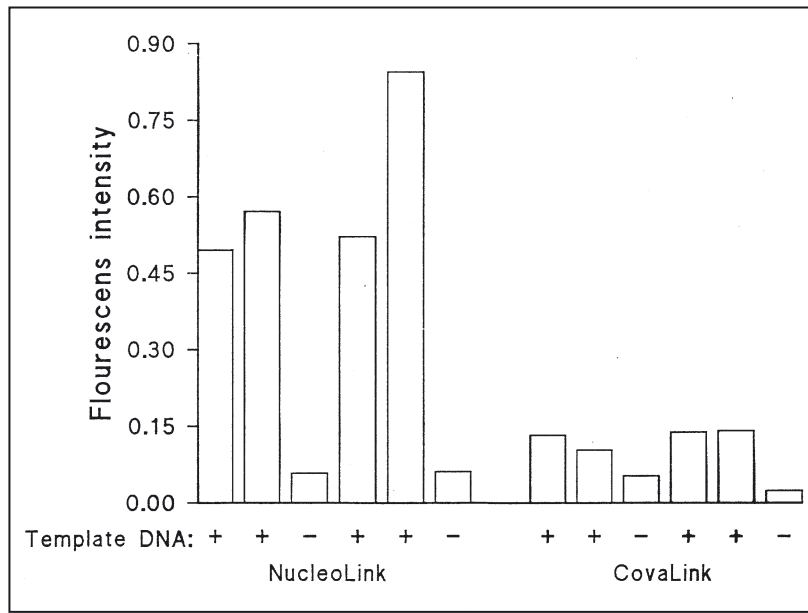
Based on experience, the use of a primer longer than 25 bases for coating is recommended.

**NucleoLink and CovaLink used for DNA hybridization**

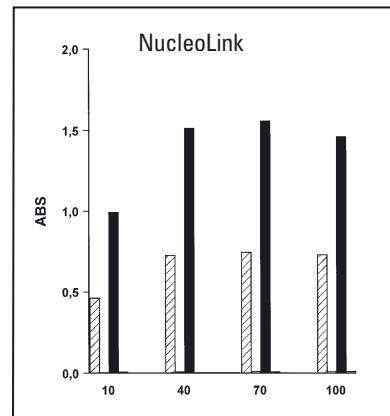
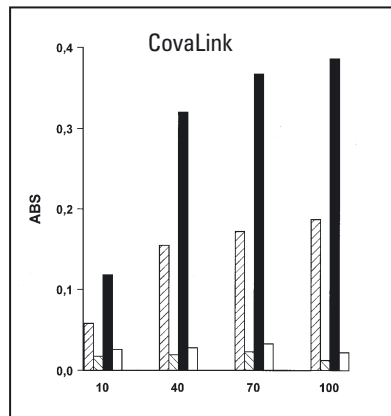
Statens Serum Institut (SSI), Copenhagen, has developed a DNA hybridization assay for the detection of infectious organisms. The capture probe was bound as described above to CovaLink and NucleoLink. For the remainder of the assay, the CovaLink and NucleoLink Strips were used in parallel. After hybridization a chromogenic substrate was added. The colour development was measured on an ELISA plate reader.

**Conclusion**

The results (Figs. 3 and 4) showed that by using NucleoLink, the amount of DNA needed for covalent immobilisation could be reduced by 90%. Furthermore, when using NucleoLink, the time needed for substrate conversion could be reduced by 50%.



**Fig. 2**  
 DIAPOPS ratios obtained in NucleoLink and CovaLink respectively.  
 +: 5 µL template DNA added before amplification.  
 -: 5 µL water added before amplification.



**Figs. 3 and 4**  
 ▨ 1 hour incubation with substrate  
 ▩ background after 1 hour incubation with substrate  
 ■ 2 hours incubation with substrate  
 □ background after 2 hours incubation with substrate.  
 Uncoated strips were used for background measurements.

Note the difference in scale on the y-axis.

# Versatile PCR Assays Based on Hybridization in Thermo Scientific Nunc MicroWell Plates

Lars P. Nielsen, Department of Clinical Microbiology, Aarhus University Hospital, 8000 Århus C, Denmark

Assays based on the polymerase chain reaction (PCR) are used increasingly in clinical laboratories for the detection of microbial pathogens.

These tests are sensitive and able to detect agents that are difficult or impossible to culture. Only few commercial kits exist for the detection of microbial pathogens and often the laboratories have to develop PCR tests.

We have developed a versatile set of PCR assays with the following goals:

- Extraction procedure that can be used for most clinical samples
- One-step assays for both RNA and DNA targets
- Amplification controls that interfere minimally with target amplification
- Thermo Scientific Nunc MicroWell plate hybridization detection identical for all pathogen assays

With this set of PCR assays we are able to detect infectious diseases.

In other circumstances the PCR assays are much more sensitive and rapid to perform than the classic clinical procedure. We are at present able to detect Legionella, Mycoplasma, Enterovirus, Herpes simplex virus, Varicella-Zoster virus, Adenovirus, Influenza A and B virus as well as respiratory syncytial virus in various clinical material.

The general assay is shown in Fig. 1, and an example of a visual reading is shown in Fig. 2.

## Methods

### Nucleic Acid extraction procedure

Prepare 400 µL of guanidinium thiocyanate (4 M) and dithioethiol (1 mM) in TRIS buffer (10 mM, pH 5.6) per sample. The amplification control (RNA or DNA) is added to the guanidium buffer. Add 100 µL sample material.

Mix well. Add 500 µL isopropanol. Centrifuge at 10.000 g for 10 minutes at room temperature. Aspirate the supernatant. Add 750 µL 70% ethanol, mix and centrifuge as described above. Aspirate the

supernatant. Air dry the sample.

The amplification mix is added and the DNA is dissolved. Transfer to a PCR tube.

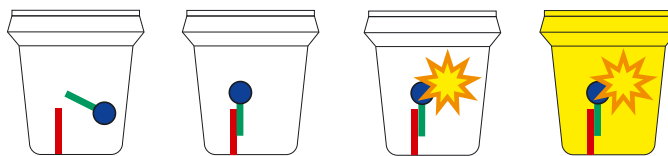
## Amplification

### DNA targets

Each pathogen undergoes 40 cycles with their specific parameters.



### RNA targets

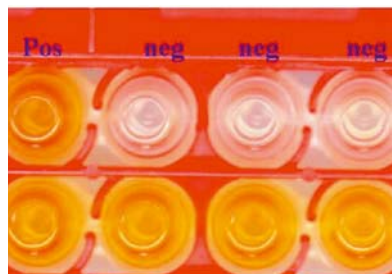
Incubation for 30 minutes at 42°C for the reverse transcriptase step. The RT enzyme is denatured and released from the nucleic acid by heating to 95°C for 60 seconds. Amplify as for DNA targets.



**Fig 1.**  
Assay development

A capture probe is covalently bound to the NucleoLink well. The biotinylated PCR product produced in a separate PCR vessel is denatured and captured onto the surface by the probe. Added streptavidin conjugated to horseradish peroxidase binds to the biotin and is afterwards detected by the addition of a peroxidase specific colorimetric substrate.

 Biotinylated PCR product  Capture probe



**Fig 2.**  
Solid phase hybridization in a NucleoLink Strip

The first row shows the hybridization result using a probe specific for the pathogen - in this case enterovirus. The second row shows the corresponding hybridization of the amplification of control DNA. Four samples were tested, and only the first sample is positive for the virus. All the hybridizations for the control DNA are positive.

## Detection of amplified material in Thermo Scientific Nunc NucleoLink Strips

### 1. Immobilization of capture probe

5'-phosphorylated probes are linked covalently to Nunc™ NucleoLink™ Strips. To each well, add 100 µL probe (100 nm) in freshly made 10 mM 1-ethyl-3-(3-dimethylaminopropyl)-carbodiimide (EDC) in 10 mM 1-methylimidazol (1-MeIm) (pH 7.0). Incubate for 5 hours at 50°C. Wash three times with 100 mM Tris-HCl (pH 7.5), 150 mM NaCl and 0,1% Tween 20. Wash with distilled water three times.

### 2. Capture of PCR products in NucleoLink Strips

Both primers used for the PCR assays are biotinylated at the 5' end.

The amplified material is denatured by adding an equal volume of 1.6% NaOH. 100 µL hybridization buffer (1 M phosphate buffer, pH 5.6) is added to each NucleoLink well. 25 µL of the denatured PCR product is added per well. Incubate at 37°C for 60 minutes. Wash three times with PBS containing 0.5% Tween 20 and add 100 µL streptavidin conjugated to

horseradish peroxidase. Incubate for 15 minutes. Wash as described above and add TMB (3,3', 5,5' tetramethylbenzidine) substrate. After 10 minutes, 100 µL 0.1 M sulphuric acid is used to stop the color development. The result is read at 450 nm in an ELISA reader.

### The construction of amplification controls

#### DNA controls

The primer sequence for the pathogen is added to the 5' end of a specific CMV (cytomegalovirus) sequence. After amplification the PCR product is used as an amplification control. To avoid competition between control DNA and target DNA from the pathogen, a mutation is introduced in the primers for the control. This leads to a higher affinity of the primers for the pathogen increasing the sensitivity of the assay as shown in Fig. 3.

#### RNA controls

As above except that a RNA polymerase specific control is produced by adding a RNA promoter sequence to one of the primer sequences. Transcription is done using T7 RNA polymerase.

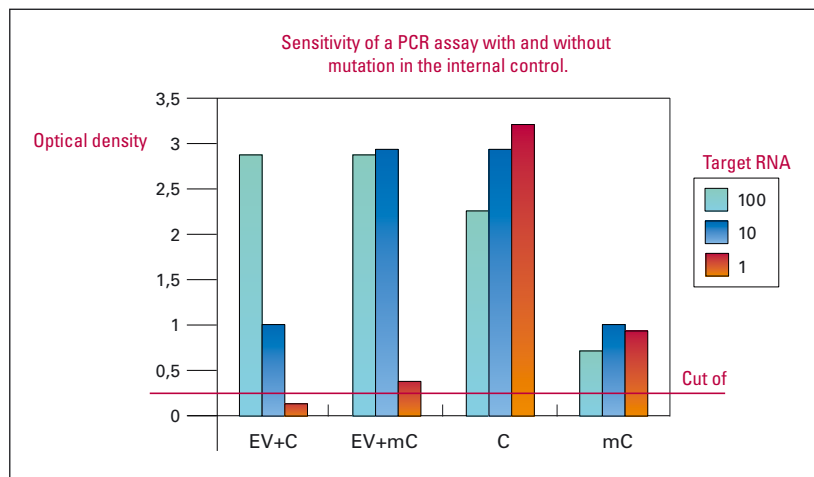
Contaminating DNA is removed by RNase free DNase. Mutations are introduced as described.

For both the DNA and the RNA control a specific hybridization for CMV is performed in a well coated with a specific CMV probe.

### Discussion

The described PCR concept has, in our hands, proved to be working in a clinical microbiological laboratory, and the described goals have been accomplished. The reagents for the PCR/RT-PCR are mixed and divided in aliquots and stored in the freezer. The only differences between the assays lie in the control nucleic acid, the PCR or RT-PCR mix and the capture probe bound to the NucleoLink hybridization wells.

As can be seen in Fig. 3, the assay is very sensitive. With a mutation in the control it is possible to detect down to one copy of the target RNA, and the use of amplification controls secures that the reagents and extraction procedure are working properly.



**Fig 3.**

### Comparison of the sensitivity of enterovirus (EV) PCR with a non-mutated (C) and a mutated control (mC)

Three samples of enterovirus were prepared by diluting the virus 1:10 in buffer. The first three bars show the sensitivity of the assay with a non-mutated control. It is clearly seen that the control competes with the control RNA (bar 7-9). When mutations are induced in the control RNA a higher sensitivity of the assay is observed (bar 4-6), and at the same time lower optical density in the control wells is seen. The inhibition of the assay is less pronounced using the mutated controls.

www.thermoscientific.com

© 2011 Thermo Fisher Scientific Inc. All rights reserved. "Tween" is a registered trademark of Uniqema Americas. All other trademarks are the property of Thermo Fisher Scientific Inc. and its subsidiaries.

# Thermo Scientific Nunc NucleoLink

## Procedure for Solid Phase PCR (DIAPOPS)

The Thermo Scientific Nunc NucleoLink surface binds DNA covalently and heat stably.

The Nunc™ NucleoLink™ strips are V-shaped with flat bottoms and are compatible with thermal cyclers and plate readers. NucleoLink can therefore be used for solid phase PCR followed by detection by hybridization in the same well (DIAPOPS).

The strips are available in transparent, black and white for colorimetric, fluorescent and luminescent detection of DNA. This Tech Note gives a detailed protocol for DIAPOPS.

### Preparation for and covalent immobilization of solid phase primer

- The solid phase primer should be aminated or phosphorylated at the 5' end, and a linker of at least 10 T's (thymidine) should be added between the active primer sequence and the 5' end group.
- Prepare a freshly made coating mix consisting of 100 nm solid phase primer and 10 mm EDC (1-ethyl-3-(3-dimethylaminopropyl)-carbodiimide) in 10 mm 1-methyl-imidazole (1-MeIm) (pH 7.0).
- Add 100 µL of this coating mix to each NucleoLink well. This gives a total of 10 pmol of the 5'-modified solid phase primer per well.
- Seal the NucleoLink Strips (e.g. with Thermo Scientific Nunc Sealing Tape).
- Incubate the NucleoLink Strips at 50°C for 4-24 hours.
- Wash the empty NucleoLink wells three times, soak for 5 minutes and wash three times, all with 100 mm Tris-HCl (pH 7.5), 150 mm NaCl and 0.1% Tween 20 at room temperature (RT). Empty the strips.
- Wash once with deionized sterile water.
- The empty, unsealed coated NucleoLink Strips can be stored at 4°C or below in an polyethylene bag.

### Amplification

- BSA must be added to the PCR mix in a final concentration of 1 mg/mL which should not be exceeded as this may block the solid phase amplification. 0.1%-0.25% Tween 20 is also recommended.
- The primers must be added to the PCR mix in a ratio of 1:8. We use 25 pmol per reaction of the liquid phase primer and 25/8 pmol per reaction of the primer used as the solid phase primer.
- Add PCR mix to the wells (normally 20 µL or 45 µL).
- Add DNA template to each well (the total reaction volume has been tested with both 25 µL and 50 µL).
- Seal the NucleoLink Strips with Sealing Tape 8.
- Place the strips in a thermal cycler block.
- Place the silicone spacer plate on the tape sealed NucleoLink Strips.
- Temperature cycle the strips with the temperatures and

cycling parameters specific for the system.

- Remove the NucleoLink Strips and empty them.
- Wash the empty NucleoLink wells three times, soak for 5 minutes and wash three times, all with freshly made 0.2 M NaOH and 0.1% Tween 20 at RT.
- Wash the empty NucleoLink wells three times, soak for 5 minutes and wash three times, all with 100 mm Tris-HCl (pH 7.5), 150 mm NaCl, and 0.1% Tween 20 at RT.

### Detection

- Add 100 µL of 50-100 nm biotinylated hybridization probe diluted in 5 x SSC, 0.1% Tween 20 and 0.5% blocking reagent (BR) to each well.
- Seal the NucleoLink Strips with sealing tape and incubate at 45-50°C for one to 20 hours.
- Wash the empty NucleoLink wells three times at RT with 0.5 x SSC and 0.1% Tween 20.
- Soak for 15 minutes at 50°C with 0.5 x SSC and 0.1% Tween 20.
- Wash three times at RT with 0.5 x SSC and 0.1% Tween 20.
- Detection of biotin label on the hybridized probe:  
When using alkaline phosphatase (AP): Add to each well 100 µL AP conjugated streptavidin diluted 1:3000 (or as the producer suggests) in 100



mm Tris-HCl (pH 7.5), 150 mm NaCl, 0.1% Tween 20 and 0.5% BR.

When using Horse Radish Peroxidase (HRP): Add to each well 100  $\mu$ L HRP conjugated streptavidin diluted 1:5000 (or as the producer suggests) in 100 mm Tris-HCl (pH 7.5), 150 mm NaCl, 0.1% Tween 20 and 0.5% BR.

7. Seal the wells with sealing tape and incubate for one hour at 37°-50°C.

8. Wash the empty NucleoLink wells three times, soak for 5 minutes, and wash three times with 100 mm Tris-HCl (pH 7.5), 150 mm NaCl and 0.1% Tween 20 at RT.

9. Substrate incubation:

When using 4-methylumbelliferyl phosphate: Add 100  $\mu$ L of 1 mm 4-MUP dissolved in 1 M diethanolamine (pH 9.8) and 1 mm MgCl<sub>2</sub> to each well. Incubate at 37°-50°C in the dark for 30-60 minutes. Add 50  $\mu$ L of 3 M K<sub>2</sub>HPO<sub>4</sub> to stop the hydrolyzation of 4-MUP.

When using p-nitrophenyl

phosphate: Add 100 mL of 1 or 10 mg/mL pNPP in 1 M diethanolamine (pH 9.8) and 1 mm MgCl<sub>2</sub> to each well. Incubate at RT for 30 minutes (10 mg/mL) to 24 hours (1 mg/mL). Add 100  $\mu$ L of 1 M NaOH to stop hydrolyzation of pNPP.

When using TMB: Add 100  $\mu$ L of the ready-to-use solution to each well. Incubate for 30 minutes at RT. Add 100  $\mu$ L 0.1 M H<sub>2</sub>SO<sub>4</sub> to stop the reaction. (Re-hybridization is not possible after addition of acid).

10. To measure the signal:

Detection of hydrolyzed

4-MUP: Determine the signal in a fluorescence plate reader: Excitation 360 nm, emission 450 nm.

Detection of hydrolyzed pNPP: Measure OD in a standard plate reader at 405 nm.

Detection of TMB: Measure OD in a standard plate reader at 450 nm after the reaction has been stopped with acid (if the reaction is not stopped with acid, the color is blue and can be measured at 655 nm).

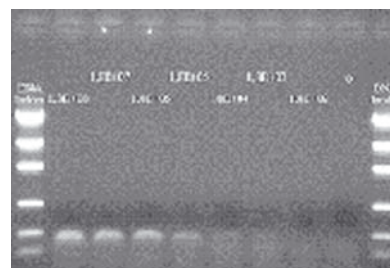
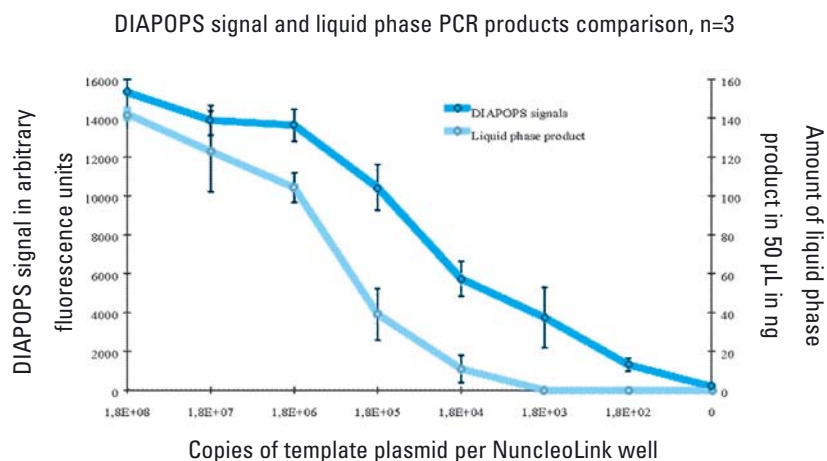
### Preparation for re-hybridization or storage

1. Remove substrate from wells after measuring the catalyzed substrate.
2. Wash the empty NucleoLink wells three times, soak for 5 minutes and wash three times with freshly made 0.2 M NaOH and 0.1% Tween 20 at RT.
3. Wash the empty NucleoLink wells three times, soak for 5 minutes, and wash three times with distilled water or 100 mm Tris-HCl (pH 7.5), 150 mm NaCl and 0.1% Tween 20 at RT.
4. The washed empty NucleoLink Strips can be stored at 4°C or below in an ethylene bag.

### Re-hybridization

1. No re-hydration of the NucleoLink Strips is necessary after storage. Commence with step 1 in the detection section and add hybridization solution directly to the empty dry wells.

Fig. 1



Comparison of DIAPOPS and detection by gel electrophoresis. Using DIAPOPS the detection limit (1800 copies) was at least 1:10 improved compared to the gel (18000 copies).

## References

- 1: Rasmussen et al.  
Biotechnology International 1999, Vol. 2,  
303-307.
2. Lundin BS, Karlsson MR, L. A. Svensson  
LA, Hanson LÅ, Dahlgren UIH, Telemo E.  
Active suppression in orally tolerized  
rats coincides with in situ transforming  
growth factor-beta (TGF- ) expression in  
the draining lymph nodes.  
Clinical & Experimental Immunology  
1999, Vol. 116(1), 181-187.
3. Niessen L, Klusmann J and Vogel RF.  
Quantitative estimation of Fusarium  
graminearum DNA using a solid phase  
PCR assay (DIAPOPS).  
Journal of Food Mycology 1998, 1:73-84.
4. Oroskar, Rasmussen SE, Rasmussen  
HN, Rasmussen SR, Sullivan BM and  
Johansson A.  
Detection of immobilized amplicons by  
ELISA-like techniques.  
Clin Chem 1996, 42:1547-1555.
5. Rasmussen SR, Rasmussen HB, Larsen  
MR, Hoff-Jorgensen R and Cano RJ.  
Combined polymerase chain reaction-  
hybridization microplate assay used  
to detect bovine leukemia virus and  
Salmonella.  
Clin. Chem. 1994, 40:200-205.

[www.thermoscientific.com/oemdiagnostics](http://www.thermoscientific.com/oemdiagnostics)

© 2011 Thermo Fisher Scientific Inc. All rights reserved. "Tween" is a registered trademark of Uniqema Americas. All other trademarks are the property of Thermo Fisher Scientific Inc. and its subsidiaries.

# Thermo Scientific Nunc NucleoLink

## Procedure for PCR ELISA

The Thermo Scientific Nunc NucleoLink surface binds DNA covalently and heat-stably. It is available in C96 and BreakApart format for hybridization applications. The surface also comes as our classical Nunc™ NucleoLink™ Strips for DNA hybridization applications as well as DIAPOPS.

For a protocol on DIAPOPS, please see Tech Note No. 36, Thermo Scientific Nunc NucleoLink Procedure for Solid Phase PCR (DIAPOPS). This Tech Note gives a detailed protocol for PCR ELISA.

### Preparation for and covalent binding of solid phase capture probe

1. The solid phase primer should be aminated or phosphorylated at the 5' end, and a linker of at least 10 T's (thymidine) should be added between the active primer sequence and the 5' end group.
2. Prepare a freshly made coating mix consisting of: 100 nm solid phase capture oligonucleotide and 10 mm EDC (1-ethyl-3-(3-dimethylaminopropyl)-carbodiimide) in 10 mm 1-methyl-imidazole (1-MeIm) (pH 7.0).
3. Add 100  $\mu$ L of this coating mix to each NucleoLink well. This gives a total of 10 pmol of the 5'-phosphorylated or aminated solid phase oligonucleotide per well.
4. Seal the NucleoLink Strips (e.g. with Thermo Scientific Nunc Sealing Tape).
5. Incubate the NucleoLink Strips at 50°C for 4-24 hours.

6. Wash the empty NucleoLink wells three times, soak for 5 minutes and wash three times, all with 100 mm Tris-HCl (pH 7.5), 150 mm NaCl and 0.1% Tween 20 at room temperature (RT). Empty the strips.
7. Wash the empty NucleoLink wells three times, soak for 5 minutes and wash three times, all with deionized sterile water.
8. The empty, coated NucleoLink Strips can be stored at 4°C or below in a polyethylene bag.

### Amplification

1. The amplification should be made as usual in traditional PCR tubes.
2. In order to label the PCR product, the amplification should be made using either:
  - a) Biotinylated primers (one or both PCR primers can be labeled), or
  - b) Addition of DIG-11-dUTP (a digoxigenine labeled oligonucleotide) at a concentration of 4  $\mu$ M. The concentration of dTTP should be lowered to 0.125 mM. All other concentrations remain unchanged. If non-labeled PCR products are detected, a labeled probe, complementary to the same strand as the solid phase capture probe, should be added during hybridization.

### Detection

1. Add 10  $\mu$ L of the PCR product to the NucleoLink wells in which the solid phase capture probe is covalently bound.

2. Add 10  $\mu$ L of 1 M NaOH with 0.5 mg/mL thymol blue. This liquid is dark blue.
3. Incubate for 10 minutes at RT.
4. To each well, add 80  $\mu$ L of 6.25 x SSC, 0.625% blocking reagent (BR), 0.125% Tween 20 and 0.5 M  $\text{NaH}_2\text{PO}_4$  adjusted to pH 6.5 with NaOH. The pH of this mixture is 7.5, and the liquid should become yellow. If the color is red (acidic) or blue (alkaline), the hybridization will not be successful.
5. Incubate for 30 minutes-2 hours at 50°C (each system should be optimized individually).
6. Wash the NucleoLink wells three times at RT with 0.5 x SSC and 0.1% Tween 20.
7. Soak for 15 minutes at 50°C with 0.5 x SSC and 0.1% Tween 20.
8. Wash three times at RT with 0.5 x SSC and 0.1% Tween 20.
9. Detection of biotin-labeled PCR product
  - a) When using Alkaline phosphatase (AP): Add to each well 100  $\mu$ L AP conjugated streptavidin diluted 1:3000 (or as the producer suggests) in 100 mm Tris-HCl (pH 7.5), 150 mm NaCl, 0.1% Tween 20 and 0.5% BR.
  - b) When using Horse Radish Peroxidase (HRP): Add to each well 100  $\mu$ L HRP conjugated streptavidin diluted 1:5000 (or as the producer suggests) in 100 mm Tris-HCl (pH 7.5), 150 mm NaCl, 0.1% Tween 20 and 0.5% BR.

10. Detection of digoxigenin labeled PCR product  
Add to each well 100 µL anti-DIG conjugated AP diluted 1:5000 in 100 mM Tris-HCl (pH 7.5), 150 mM NaCl, 0.1% Tween 20 and 0.5% BR.
11. Incubate for one hour at 37°-50°C sealed with Sealing Tape.
12. Wash the empty NucleoLink wells three times, soak for 5 minutes and wash three times with 100 mM Tris-HCl (pH 7.5), 150 mM NaCl and 0.1% Tween 20 at RT.
13. Two substrates have been tested with AP; 4-MUP (4-methylumbelliferyl phosphate) and pNPP (para nitrophenyl phosphate). One color forming reagent has been tested with HRP; TMB (3,3',5,5'-tetramethylbenzidine) in a ready-to-use solution.
  - a) When using 4-MUP: Add 100 µL of 1 mM 4-MUP dissolved in 1 M diethanolamine (pH 9.8) and 1 mM MgCl<sub>2</sub> to each well.
  - b) When using pNPP: Add 100 µL of 1 or 10 mg/mL pNPP in 1 M diethanolamine (pH 9.8) and 1 mM MgCl<sub>2</sub> to each well.
  - c) When using TMB: Add 100 µL of the ready-to-use solution to each well.
14. Substrate incubation The NucleoLink Strips should be sealed with Sealing Tape when incubating for longer than 30 minutes.
  - a) When using 4-MUP, incubate at 37°-50°C in the dark for 30-60 minutes. To stop the hydrolyzation of 4-MUP, add 50 µL of 3 M K<sub>2</sub>HPO<sub>4</sub>.
  - b) When using pNPP, incubate at RT for 30 minutes (10 mg/mL) to 24 hours (1 mg/mL). Add 100 µL of 1 M NaOH to stop hydrolyzation of pNPP.
  - c) When using TMB, incubate for 30 minutes at RT. Add 100 µL 0.1 M H<sub>2</sub>SO<sub>4</sub> to stop the reaction. Note: Re-hybridization is not possible after addition of acid.
15. To measure the signal
  - a) To detect of hydrolyzed 4-MUP, determine the signal in fluorescence plate reader: Excitation 360 nm, emission 450 nm (also if the reaction has been stopped with K<sub>2</sub>HPO<sub>4</sub>).
  - b) For detection of hydrolyzed pNPP, measure OD in a normal ELISA plate reader at 405 nm (also if the reaction has been stopped with NaOH). For detection of TMB, measure OD in a normal ELISA plate reader at 450 nm after the reaction has been stopped with acid (if the reaction is not stopped with acid, the color is blue and can be measured at 655 nm).

## References

1. Versatile PCR assays based on hybridization in MicroWell Plates. Thermo Scientific Nunc Tech Note No. 33.
2. Rasmussen et al. *Biotechnology Int.* 1999, Vol 2, 303-307.
3. Ten Haaft P, Verstrepen B, Überla K, Rosenwirth B and Heeney J. A Pathogenic Threshold of Virus Load Defined in Simian Immunodeficiency Virus- or Simian-Human Immunodeficiency Virus-Infected Macaques. *Journal of Virology* 1998, Vol. 72, 12:10281-10285.
4. Chevrier D, Rasmussen SR and Guesdon JL. PCR product quantification by non-radioactive hybridization procedures using an oligonucleotide covalently bound to microwells. *Molecular and Cellular Probes* 1993, Vol. 7, 3:187-197

# Thermo Scientific Nunc Immobilizer Amino Surface

## Protocol for Coupling Proteins

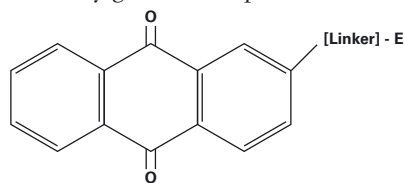
Kenneth Harlow and Henrik M. Pfundheller, Exiqon Laboratories, Denmark

The Thermo Scientific Nunc Immobilizer reagent range is manufactured using a patented photo-chemical method<sup>1</sup> for covalent coupling of ligands to polymer materials.

The photo-coupling introduces an ethylene glycol spacer and a stable electrophilic group that reacts with nucleophiles such as free amines, thiols or hydroxy groups. The spacer design and the density of electrophilic groups on this surface are optimized for peptide and protein based immuno-diagnostic assays.

### Background

The proprietary Nunc<sup>™</sup> Immobilizer<sup>™</sup> reagent (Fig. 1) incorporates an electrophilic functional group that will react with any good nucleophile.



**Fig. 1**

Proprietary AQ Immobilizer reagent. The electrophilic group, E, is separated from the photo-reactive anthraquinone via an ethylene glycol linker.

In the case of proteins, this essentially limits reaction to primary amine and thiol groups (Fig. 2). Other potential nucleophilic groups on proteins, such as tyrosine hydroxyl and histidine imidazole groups, are either not nucleophilic at the pHs

where most proteins are stable, or are such weak nucleophiles that they are competed out by both the overabundance and higher reactivity of the highly nucleophilic amine and thiol groups. Furthermore, reactivity of the amine and thiol groups is a function of  $pK_a$  and can be modulated by pH. Thus, amines are poor nucleophiles when they are protonated and are expected to react less vigorously at pHs below the  $pK_a$  of the  $\epsilon$ -amine group, whereas the thiol group of cysteine reacts more vigorously in the thiolate form found above the  $pK_a$  of the thiol group.

Therefore, it may be possible to limit reaction to thiol groups by running reactions closer to neutral pH where the thiolate anion will be the most reactive species. These considerations must be weighed with care, as the  $pK_a$ s of ionizable groups in proteins are often very different from the  $pK_a$ s of the respective amino acid side chains in solution, and therefore may not reflect the reactivity of the potential nucleophilicity of these groups in proteins.

### Suggested Guidelines and Protocol

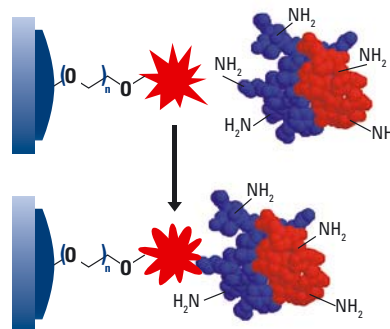
The chemistry of proteins is very diverse, and it is therefore difficult to develop a generalized protocol for coupling with the Immobilizer reagent that works well for all proteins. A certain amount of optimizing may be necessary to obtain the best results. Since the target nucleophiles are either primary amines or thiols,

the Proteomics group at Exiqon employed two different conditions for the covalent coupling reactions. One of these conditions will usually provide at least acceptable results, but users are encouraged to take into consideration the individual properties of the proteins with which they are working and develop their own set of conditions, if need be.

- Proteins are coupled to the Immobilizer Amino reagent using two different buffer systems:
  - Phosphate buffered saline (PBS; 10 mm Na phosphate buffer, pH 7.5, 150 mm NaCl)
  - 100 mm Na carbonate, pH 9.6

PBS will favor coupling thiols alone, whereas carbonate will facilitate reaction with both amine and thiol functions.

- When coupling proteins to surfaces coated with the Immobilizer reagent, it is suggested that a dilution series of the protein of interest be run in



**Fig. 2.**

Coupling of protein to surface bound AQ Immobilizer reagent.

the two buffers above.

A suitable protein concentration at which to start is around 100 µg/mL. Coupling times vary and should be determined empirically, but a good starting place is a one hour incubation at ambient temperature. Be aware that both temperature and protein concentrations affect the reaction rate. Furthermore, amine buffers and other nucleophiles should not be present in the protein solutions used for immobilization.

- After coupling to the surface, remaining Immobilizer

electrophilic groups are quenched by reaction with 10 mM ethanolamine in 100 mM Na carbonate, pH 9.6 buffer for one hour at ambient temperature. This eliminates the possibility of the surface reacting at a later point in time with other nucleophiles and also introduces a hydroxyl functional group which makes the surface more hydrophilic and less prone to non-specific absorption. The surface can now be used for immuno-assay purposes without the need for a non-relevant blocking protein to be present in assay buffers.

#### Additional information

More information concerning immobilization of proteins on the Immobilizer Amino surface can be found on [www.thermoscientific.com](http://www.thermoscientific.com).

#### References

1. Jensen SP, Rasmussen SE, Jakobsen MH. Photochemical Coupling of Peptides to Polystyrene MicroWell Plates. *Innovations and Perspectives in Solid Phase Synthesis and Combinatorial Chemical Libraries* (1996) 419-422.

[www.thermoscientific.com/oemdiagnostics](http://www.thermoscientific.com/oemdiagnostics)

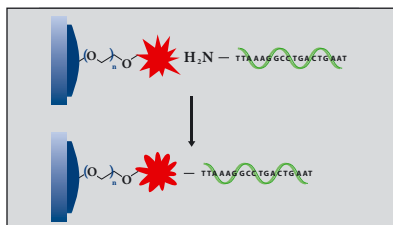
©2010 Thermo Fisher Scientific Inc. All rights reserved. "Immobilizer" is a trademark of Exiqon A/S, Vedbaek, Denmark. The product is produced under license from Exiqon A/S - EP 0820483 and foreign applications and patents. The anthraquinone technology is covered by U.S. Patent no. 6,033,784, EP 0820483, JP 3124037 and AU 699321 owned by Exiqon A/S. All other trademarks are the property of Thermo Fisher Scientific Inc. and its subsidiaries.

# Custom-made Thermo Scientific Nunc Immobilizer for DNA Binding

Nana Jacobsen, M.Sc. and Jan Skouv, Ph.D.

Thermo Scientific Nunc Immobilizer DNA MicroWell plates and strips for covalent immobilization of aminated DNA can be custom-made upon request.

The production of the Nunc™ Immobilizer™ DNA surface introduces an ethylene glycol spacer and a stable electrophilic group that reacts with nucleophiles such as free amines. The spacer design and the density of electrophilic groups on this surface are optimized for detection of various types of molecules including aminated nucleic acids.



**Fig. 1.** Binding mechanism for aminated nucleic acids

## Coupling materials

- Immobilizer DNA MicroWell™ plate
- 100 mm carbonate buffer, pH 9.6
- Aminated PCR amplicon
- SSC (1 x SSC is: 150 mm NaCl, 15 mm sodium citrate, pH 7.0)
- PBST is Phosphate Buffered Saline 1 (PBS) with 0.05% (v/v) Tween 20

## Coupling protocol

1. Prepare a solution of aminated DNA in 100 mm carbonate buffer, pH 9.6. It is recommended that the amount

- of aminated DNA is optimized, however for initial experiments we suggest: 1 nm aminated DNA PCR fragments (single stranded).
2. Add the aminated DNA solution to the wells of the Immobilizer DNA plate (100 µL/well) (50 µL for 384).
3. Incubate the plate with gentle agitation at room temperature for two hours or overnight at +4°C.
4. Aspirate the wells and wash with 3 x 300 µL 2 x SSC, 0.1% (v/v) Tween 20 (3 x 100 µL for 384).
5. The DNA surface is ready for use.

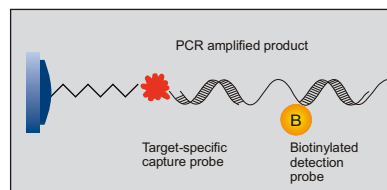
Detergents like Tween 20 effectively suppress covalent coupling of DNA and should consequently not be present in the coupling buffer. The use of competing nucleophiles like ethanolamine, lysine or tris (hydroxymethyl) amino methane (TRIS) should also be avoided in the coupling buffer.

The inclusion of small amounts of detergents like Tween 20 (0.05-1% (v/v)) in subsequent wash and assay buffers, generally improves the signal to noise ratio of the assay. Other DNA concentrations, incubation times, temperatures, buffers or pH values than those recommended here can successfully be used.

## Application examples

### 1. Detection of a PCR amplicon

Using Immobilizer DNA for the detection of a PCR amplicon.



**Fig. 2.** Detection of a PCR fragment by a target specific capture probe covalently linked to the DNA on an Immobilizer DNA plate using a biotinylated detection probe

The DNA fragment to be detected was a 98 bp fragment from pUC19<sup>2,3</sup>. This 98 bp fragment was amplified using 5'-AAC AGC TAT GAC CAT G-3' and 5'-GTA AAA CGA CGG CCA GT-3' as primers, pUC19 as template and a standard PCR kit. The fragment was amplified following the manufacturer's recommendations and incubating: 2 min. at 94°C; 30 cycles (94°C 1 min., 45°C 1 min., 72°C 2 min.); and 72°C 3 min. The yield was estimated by agarose gel electrophoresis.

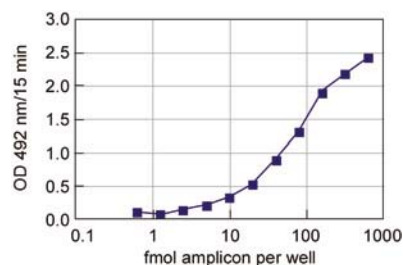
## Protocol

1. Using the recommended coupling protocol, the capture sequence 5'-amine-AAC AGC TAT GAC CAT G-3' was covalently attached to the transparent Immobilizer DNA plate surface.
2. Per well: 10 µL of the PCR reaction (approximately 40 ng) was dissolved in 2 x SSC, 0.1% (v/v) Tween 20. Boiled 5 min. and then placed on ice.
3. The specific detection probe (5'-biotin-ATG CCT GCA GGT CGA C-3') was added to

the PCR/SSC mix. 0.5 pmol detection probe per  $\mu\text{L}$ , final vol. 100  $\mu\text{L}$ . The mix was then added to the wells of the Immobilizer DNA plate and the PCR fragment was allowed to hybridise to the covalently attached capture sequence for 3 hours at 37°C (Fig. 2).

- The wells were aspirated and washed with 3 x 300  $\mu\text{L}$  2 x SSC, 0.1% (v/v) Tween 20.
- A 1  $\mu\text{g}/\text{mL}$  solution of streptavidin/HRP in PBST was dispensed into the wells (100  $\mu\text{L}/\text{well}$ ), and the plate incubated for one hour.
- The wells were aspirated and washed with 3 x 300  $\mu\text{L}$  PBST.
- A solution of 6 mm ortho-phenylene-diamine (OPD), 4 mm  $\text{H}_2\text{O}_2$  in 100 mm citric acid buffer, pH 5.0 was added to the wells (100  $\mu\text{L}/\text{well}$ ) and left for color development.
- After approximately 15 minutes, the enzyme reaction was stopped with  $\text{H}_2\text{SO}_4$ , 0.5 M (100  $\mu\text{L}/\text{well}$ ) and the absorbance in this colorimetric assay was measured at 492 nm with an ELISA reader. The result are shown in Fig. 3.

All incubations were carried out with gentle agitation at either room temperature or at 37°C when indicated.



**Fig. 3.** Detection of various amounts of the 98 bp PCR fragment from pUC19

### Special application using PCR products

With the advent of polymerase chain reaction (PCR), ligase chain reaction (LCR<sup>4</sup>), and similar techniques, double-stranded (ds) DNA fragments with a well defined DNA sequence can be prepared. In particular the efficient generations

of dsDNA fragments by PCR have found numerous applications in diverse fields of biomedicine and molecular biology.

Oligos with an amino group attached to its 5'-end can be purchased from most commercial oligo suppliers. Including one such primer in a PCR (or LCR) reaction result in the synthesis of amino-labeled dsPCR fragment. Such fragments can easily be covalently linked to the surface of the Immobilizer DNA plates and strips and used for various applications.

### Enzymatic activity

A number of important enzymes, for instance restriction enzymes, kinases, phosphatases, polymerases, methylases etc. act on DNA. The possible relation between enzymatic activity and specific DNA sequences can conveniently be tested on DNA's covalently linked to the Immobilizer DNA surface.

### Analysis of DNA binding proteins

We suggest that dsDNA's with various recognition sequences are generated and covalently attached to the Immobilizer DNA surface.

### Gene discovery

A number of gene discovery methodologies (e.g. differential display<sup>5</sup>) result in a large number of PCR fragments that have to be screened for the presence of a given consensus sequence. We suggest to attach such PCR fragments generated with one amino-labeled oligo to the surface of the Immobilizer DNA and screen for the presence of a particular DNA sequence as described below.

### Immobilization and detection of an amino-labeled PCR amplicon on the surface of Immobilizer DNA plate.

To illustrate various aspects of the performance of the Immobilizer DNA plates for detection of an amino PCR amplicon. The DNA fragment to be detected was a 630 bp fragment from human Nras<sup>6,7,8</sup>. This 630 bp fragment

was amplified using 5'-NH<sub>2</sub>-C6-spacer-CCA GCT CTC AGT AGT TTA GTA CA-3' (position 1427-1449) and 5'-AAG TCA CAG ACG TAT CTC AGA C-3' (position 2035-2056) as primers, human Nras as template and a standard PCR kit. All oligos were purified by HPLC. The fragment was amplified following the manufacturer's recommendations and incubating 3 min. at 95°C; 30 cycles (55°C 2 min., 72°C 3 min., 95°C 1 min.); 55°C 2 min. and 72°C 3 min. The yield was estimated on a standard 1% agarose gel stained with ethidium bromide.

### 2. Detection of amino PCR amplicon

- Using the recommended coupling protocol described above for a 96 well plate, the NH<sub>2</sub>-Nras amplicon was covalently attached to the Immobilizer DNA plate. 10  $\mu\text{L}$  of the PCR reaction (approximately 120 ng) was diluted in 1:2 dilutions in 100 mm carbonate buffer, pH 9.6, and 100  $\mu\text{L}$  was dispensed per well. Incubation for two hours was allowed.
- After coupling the amplicon was denatured by 200  $\mu\text{L}$  0.4 M NaOH 0.25% (v/v) Tween 20 for 5 minutes and washed with 3 x 300  $\mu\text{L}$  2 x SSC, 0.1% (v/v) Tween 20. The Nras DNA was detected by hybridization with the specific detection probe 5'-TGT GTT TGT GCT GTG GAA GAA CCC-biotin-3' (position 1549-1572). The probe was diluted in 2 x SSC, 0.1% (v/v) Tween 20 final concentration. 100  $\mu\text{L}$  0.5  $\mu\text{m}$  probe was added per well of the Immobilizer DNA plate. The detection probe was allowed to hybridise to the covalently attached sequence for two hours at 37°C.
- The wells were aspirated and washed with 3 x 300  $\mu\text{L}$  2 x SSC, 0.1% (v/v) Tween 20.
- A solution of streptavidin/HRP in PBST (1  $\mu\text{g}/\text{mL}$ ) was dispensed into the wells (100  $\mu\text{L}/\text{well}$ ), and the plate is incubated for one hour.



The wells were aspirated and washed with 3 x 300  $\mu$ L PBST.

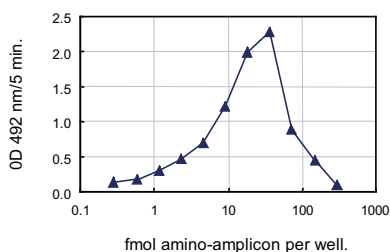
5. A solution of ortho-phenylenediamine (OPD), 6 mM and  $H_2O_2$ , 4 mM in 100 mM citric acid buffer, pH 5.0 was added to the wells (100  $\mu$ L/well) and left for color development.

After approximately five minutes, the enzyme reaction was stopped with  $H_2SO_4$ , 0.5 M (100  $\mu$ L/well), and the absorbance was measured at 492 nm using an ELISA reader.

All incubations are carried out with gentle agitation at either room temperature or at 37°C when indicated.

## Results

The result of a typical experiment is shown in Fig. 4. The experiment indicates that at high concentrations of the amino amplicon the hybridization signal decreases to the background level. This effect appears somewhat similar to the 'high-dose hook effect' described for various immuno-assays<sup>9-11</sup> and emphasizes that an optimization of amino amplicon concentrations is necessary.



**Fig. 4.** Detection of various amounts of the 630 bp PCR fragments from Nras

## References

1. Sambrook J, Fritsch EF, Maniatis T. *Molecular Cloning: A Laboratory Manual*. Cold Spring Harbour Laboratory Pres., NY (1989), 2<sup>nd</sup> ed.
2. Yanisch-Perron C, Vieira J, Messing J. Improved M13 phage cloning vectors and host strains: Nucleotide sequences of the M13mp18 and pUC19 vectors. *Gene* (1985) 33:103-119.
3. pUC 19 accession no.: VB0026.
4. Wiedmann M, Wilson WJ, Czajka J, Luo J, Barany F, Batt CA. Ligase chain reaction (LCR) - overview and applications. *PCR Methods Appl.* (1994), 3:51-64.
5. Liang P and Pardee AB. Differential display of eukaryotic messenger RNA by means of the polymerase chain reaction. *Science* (1992), 257:967-71.
6. Jensen SP, Rasmussen SE, Jakobsen MH. Photochemical Coupling of Peptides to Polystyrene MicroWell Plates. *Innovations & Perspectives in Solid Phase Synthesis & Combinatorial Chemical Libraries* (1996), 419-422.
7. Brown R and Hall I. Human N-ras: cDNA cloning and gene structure. *Nucleic Acid Research* (1985), 13:5255-5268.
8. Nras Accession no.: X02751.
9. Rodbard D, Feldman Y, Jaffe ML, Miles LE. Kinetics of two-site immunoradiometric ('sandwich') assays—II: Studies on the nature of the-high-dose hook effect. *Immunochemistry* (1978), 15:77-82.
10. Wolf BA, Garrett NC, Nahm MH. The "hook effect": high concentrations of prostate-specific antigen giving artifactually low values on one-step immunoassay. *N Engl J Med.* (1989), 320(26):1755-6.
11. Fernando SA, Wilson GS. Multiple epitope interaction in the two-step sandwich immunoassay. *J Immunol Methods* (1992), 151:67-86.

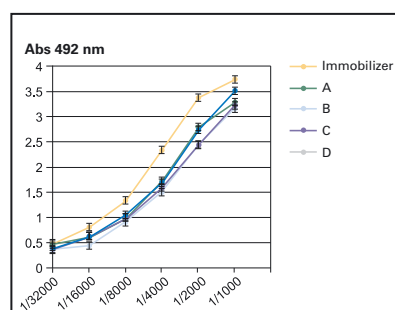
# Thermo Scientific Nunc Immobilizer

## Streptavidin and Amino

### Excellent binding capacity

A unique surface chemistry has been created for the Thermo Scientific Nunc Immobilizer plates and strips which provides excellent covalent coupling for optimal target molecule orientation and stability.

The concentrations of target molecule required for coupling is usually very low compared with what is needed for passive binding. The plate surface provides a high affinity surface especially for the coupling of small ligands.



**Fig. 1.**

Immobilizer Streptavidin plates were compared with 4 other suppliers (A, B, C, and D) of streptavidin plates, in an ELISA. Low concentrations of biotinylated anti-human IgG, (in 6 concentrations) was coupled to the streptavidin surface. Following addition of human IgG, the amount of bound human IgG was detected by adding HRP conjugated anti-human IgG and visualized by incubation with OPD substrate and measuring at 492 nm. The result shows that the required amount of added human IgG appeared to be approx. half of the amount that is required for the other suppliers' plates when measured at an OD of 1.

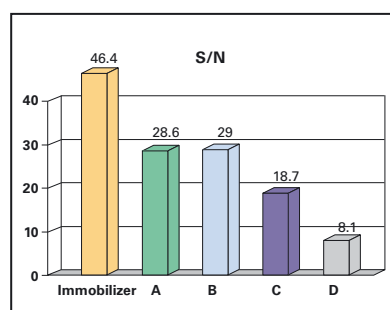
### High signal to noise ratio

Assays conducted on the Nunc™ Immobilizer™ plates and strips are characterized by high signal readouts (Fig. 1).

This, in combination with no or very low non-specific binding and thus negligible background noise, ensures superior signal to noise ratios (Fig. 2).

### Highly reproducible results

Immobilizer plates and strips are manufactured for consistent and reproducible assay results.

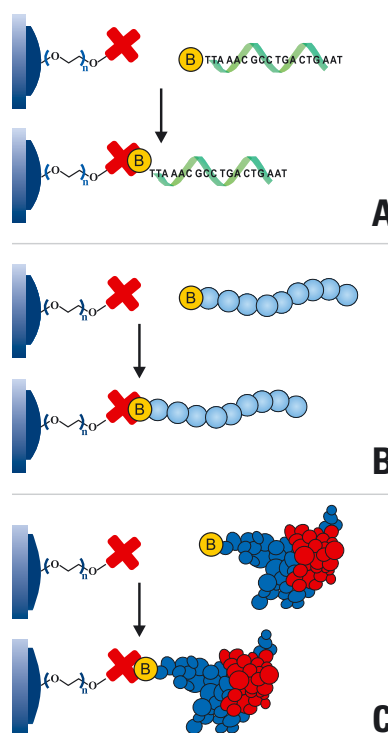


**Fig. 2.**

The signal to noise ratio was obtained on streptavidin plates from 4 different suppliers (A, B, C, and D). They were compared to the signal to noise ratio obtained on Immobilizer Streptavidin plates in an assay, where a biotinylated 15-mer DNA oligonucleotide was hybridized to a 98 bp DIG-incorporated pUC19 amplicon (400 fmol/well). The amount of hybridized DNA was detected by adding an anti-DIG antibody conjugated to HRP and reading of the signal at 450 nm following addition of TMB. The noise signal was obtained from all plates by following an identical procedure, but replacing the pUC19 plasmid template with water.

The covalently bound monolayer coating of the plates is highly uniform. Leaching is minimal, even when using very stringent washing steps. These characteristics make the Immobilizer plates and strips highly suitable for many applications.

### Mechanism of action Immobilizer Streptavidin



Coupling of A) biotinylated DNA oligonucleotide, B) biotinylated peptide, and C) biotinylated protein to the streptavidin conjugated photoprobes on the solid phase of the Streptavidin Immobilizer plates.

### No blocking

In contrast to most other coated plates, the Immobilizer plates and strips do not require separate costly, labor intensive and time-consuming blocking steps to prevent non-specific binding.

This is also due in part to the placement and density of the active sites and their spacer arms. These create a “molecular shield” which prevents direct access to the polystyrene hydrophobic surface, where non-specific binding could otherwise take place.

### Higher signal using low sample concentration

The Immobilizer products are characterized by the high signals obtained even with very low sample concentrations.

As illustrated in Fig. 3, in certain cases when samples at one tenth concentration are used, the signals obtained on the Immobilizer surface are greater than those obtained using normal high binding ELISA plates and passive absorption.

### Short incubation time

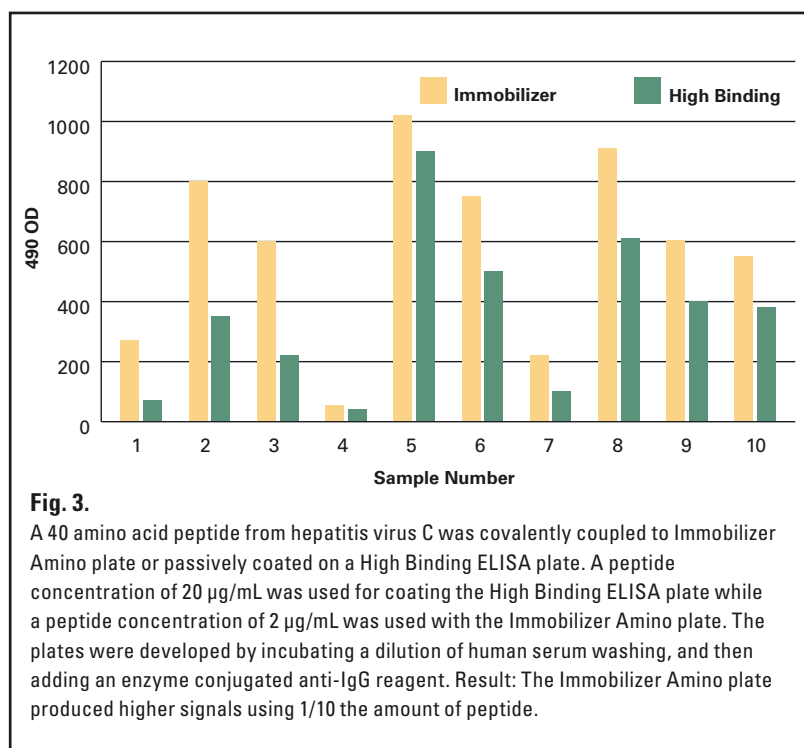
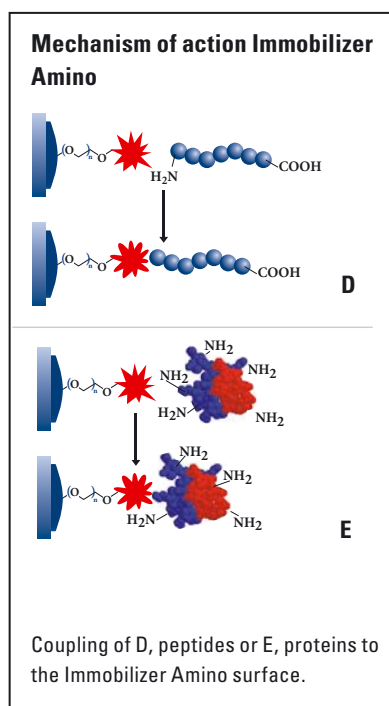
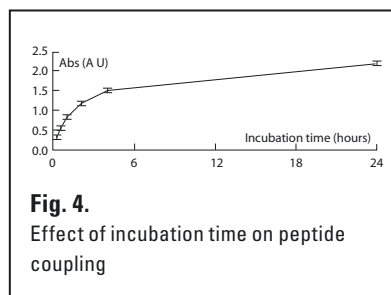
Coupling of target molecules to the Immobilizer surface takes place very quickly, compared to the time required for stable coating by passive adsorption.

The Immobilizer surface can be saturated after approximately 4 hours incubation with gentle shaking.

The coupling efficiency is typically unaffected by pH. However, one must be aware that pH can conformationally change the biomolecules that are bound. The presence of non-ionic detergents suppresses the coupling reaction.

### Long term stable at room temperature

The shelf life of the Immobilizer plates and strips exceeds one year, when they are stored in their unopened packaging at room temperature. The manufacturing date is printed on the package. The Immobilizer Streptavidin has a minimum shelf life post manufacturing of 18 months. For Immobilizer Amino surface the period is at least 2 years.



# Streptavidin Coated Plates for Molecular Biology

Thermo Scientific Nunc Streptavidin coated plates are ideal for binding of small biotinylated molecules and therefore have several applications in molecular biology as well as in immunology. In this Tech Note we have compared the Streptavidin coated plates with two different types of Streptavidin coated plates from leading manufacturers by performing a DNA hybridization assay and a PCR-ELISA.

## DNA hybridization assay

DNA hybridization assays were performed in order to measure the capacity of the Streptavidin coated plates to bind biotinylated oligonucleotides.

A competitive assay was performed. 100 nm biotinylated capture oligonucleotide and varying concentrations of free biotin were added to the surface of the Streptavidin coated plates. Captured oligonucleotide was detected by hybridization of a fluorescein labeled oligonucleotide detection probe. The Thermo Scientific Nunc Streptavidin coated

### Fig. 1. DNA hybridization assay

The wells were coated with 100 nm biotinylated oligonucleotide and varying concentrations of free biotin. The amount of captured biotinylated oligonucleotide was measured by hybridization with a fluorescein labeled detection probe. The amount of hybridized DNA is given as arbitrary fluorescence signal. A background fluorescence level, due to unspecific binding of antibody was for all the tested plates lower than 2.5% (results not shown).

plates were tested against two Streptavidin coated plates from leading manufacturers (Fig. 1). The Nunc™ Streptavidin coated plates have a sensitivity as good as or better than the plates from leading manufacturers.

## PCR-ELISA

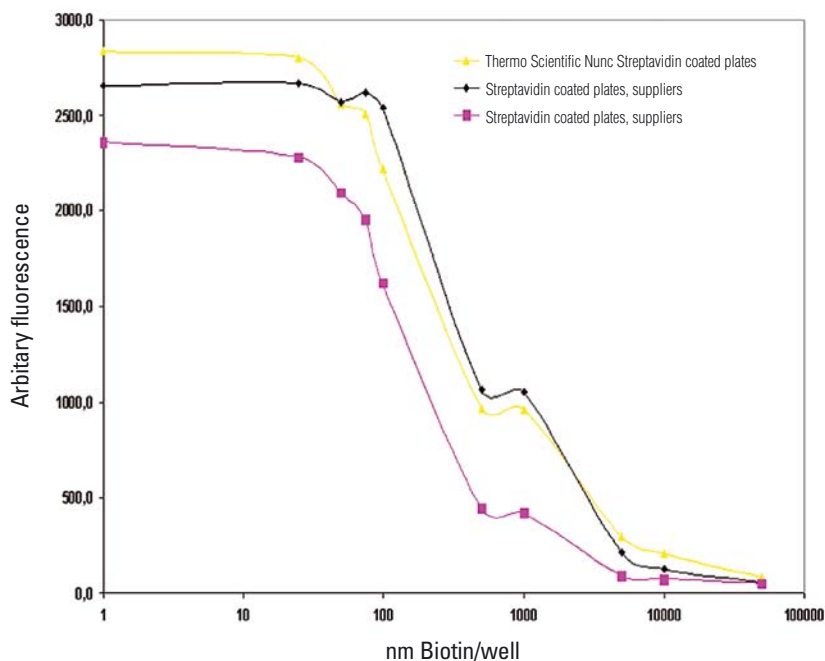
To estimate the amount of PCR product that can be hybridized to the Nunc Streptavidin coated plates a PCR-ELISA was performed. A serial dilution of a digoxigenin labeled PCR-amplified product was added to the wells, and the amount of hybridized PCR product was detected with anti-digoxigenin conjugated alkaline phosphatase. As seen in Fig. 2, Nunc Streptavidin coated plates have a sensitivity similarly to the two other plates tested. It is possible to detect 0.45 ng PCR products,

corresponding to  $2.3 \times 10^{-15}$  moles. The sensitivity of the Streptavidin coated plates is 1:10 in comparison to detection of PCR amplicons by gel electrophoresis. Furthermore, the applications of ELISA methods make it easier to analyse a larger number of samples.

## Methods

### Binding of capture oligonucleotides to Streptavidin plates

The capture oligonucleotide has a biotin group and a spacer of 10 Thymidine in the 5' end. 100  $\mu$ L of a coating mix containing 100 nm capture oligonucleotide and varying known amounts of free biotin (50,000 nm - 0 nm) in 100 mm Tris-HCl (pH 7.5), 150 mm NaCl and 0.1% Tween 20 were added to each well. The wells were sealed and incubated at 37°C for one hour. The wells were washed three



times, soaked for five minutes and washed three times, all with 100 mm Tris-HCl (pH 7.5), 150 mm NaCl, and 0.1% Tween 20 at room temperature.

### Hybridization

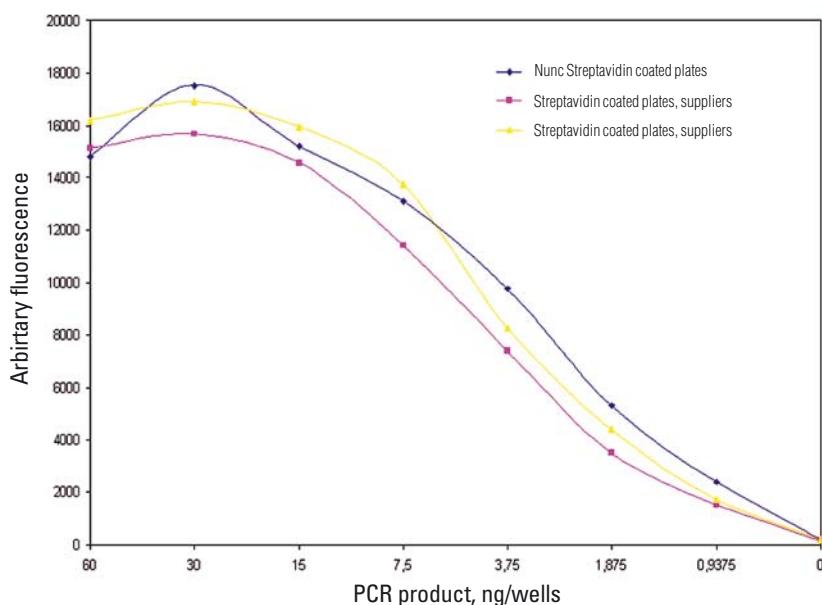
A solution of 0.25 nm 5' fluorescein labeled detection probe and 50 nm unlabeled detection probe in 100  $\mu$ L hybridization buffer (5 x SSC, 0.1% Tween 20, 0.5% blocking reagent) were added to each well and samples hybridized for one hour at 50°C. After hybridization, the wells were washed three times, soaked for 15 minutes and washed three times, all with 0.5 x SSC, 0.1% Tween 20. Anti-fluorescein conjugated alkaline phosphatase was diluted 500 times in 100 mm Tris-HCl (pH 7.5), 150 mm NaCl, 0.1% Tween 20, 0.5%

blocking reagent and 100  $\mu$ L were added to each well. The wells were incubated for one hour at 50°C and then washed three times, soaked for five minutes and washed three times, all with 100 mm Tris-HCl (pH 7.5), 150 mm NaCl, and 0.1% Tween 20 at room temperature. 100  $\mu$ L substrate solution (1 mm 4-methylumbelliferyl phosphate dissolved in 1 M diethanolamine (pH 9.8) and 1 mm MgCl<sub>2</sub>) were added, and the enzyme reaction was carried out for 30 minutes at 50°C. The fluorescence signal was read on a fluorescence plate reader: excitation 355 nm, emission 450 nm.

### PCR amplification and detection

Amplification reactions were performed in a total volume of 50  $\mu$ L containing buffer (10 mm Tris-

HCl (pH 8.3), 50 mm KCl, 0.1% Tween 20), 2.5 mm MgCl<sub>2</sub>, 1 mg/mL BSA, 4  $\mu$ M DIG-11-dUTP, 0.1 mm dTTP, 0.2 mm of dATP, dCTP and dGTP, respectively, 0.5  $\mu$ M of each primer, 1 U Taq DNA polymerase and DNA template ( $10^{-15}$  moles). The PCR cycle was: 94°C for 10 minutes, cycle 1-35: 94°C for 25 seconds, 55°C for 25 seconds, 72°C for 25 seconds, followed by one cycle at 72°C for 10 minutes. The PCR amplification product was analysed on a 1% agarose gel and quantitated. A serial dilution of the amplification product was performed, and 10  $\mu$ L were denatured with 10  $\mu$ L 1 M NaOH. Denatured PCR product was transferred to Streptavidin coated plates, containing 80  $\mu$ L of 6.25 x SSC, 0.625% blocking reagent, 0.125% Tween 20 and 0.5 M NaH<sub>2</sub>PO<sub>4</sub> (pH 6.5). The wells were incubated for one hour at 50°C and then washed three times, soaked for 15 minutes at 50°C, washed three times all with 0.5 x SSC and 0.1% Tween 20 at room temperature. To each well 100  $\mu$ L anti-digoxigenin conjugated alkaline phosphatase diluted 1:500 in 100 mm Tris-HCl (pH 7.5), 150 mm NaCl, 0.1% Tween 20 and 0.5% blocking reagent was added. The rest of the detection procedure were the same as described under hybridization.



**Fig. 2.**  
**PCR-ELISA**

Detection of PCR products on Streptavidin coated plates. Denatured digoxigenin labeled PCR product was captured by a probe immobilized to the Streptavidin coated plates and detected by anti-digoxigenin conjugated alkaline phosphatase. The detection level is given as arbitrary fluorescence signal.

www.thermoscientific.com

© 2011 Thermo Fisher Scientific Inc. All rights reserved. "Tween" is a registered trademark of Uniqema Americas. All other trademarks are the property of Thermo Fisher Scientific Inc. and its subsidiaries.

### Conclusion

Using the Nunc Streptavidin coated plates it is possible to detect 0.45 ng PCR products, corresponding to  $2.3 \times 10^{-15}$  moles.

# Thermo Scientific Nunc Immobilizer Streptavidin

## Application example: Colorimetric detection of human IgG in blood plasma samples

This note describes a sandwich immunoassay performed using Thermo Scientific Nunc Immobilizer Streptavidin plates. These plates are manufactured using a patented photochemical method<sup>1</sup> for covalent coupling of ligands to polymer surfaces.

Streptavidin is a high affinity biotin-binding protein, isolated from *Streptomyces avidinii*. It is covalently coupled to the polystyrene surface via a polyethylene glycol spacer arm.

Nunc™ Immobilizer™

Streptavidin plates are optimized for easy and sensitive detection of various types of biotinylated biomolecules such as oligonucleotides, peptides, and proteins.

### Introduction

The assay was performed in a clear 96 well Immobilizer Streptavidin plate to demonstrate a non-competitive sandwich ELISA. Using biotinylated capture antibody and horseradish peroxidase (HRP) labeled detector antibody, human IgG in plasma samples was detected.

In this type of assay, the amount of bound detector antibody is proportional to the amount of analyte present in the sample. Bound HRP detector antibody is measured by incubating the wells with the substrate OPD and reading the resulting absorbance.

### Materials

- 96 Well Immobilizer Streptavidin plates
- PBST, pH 7.2 (Phosphate buffered saline containing 0.05% Tween 20)
- Biotinylated rabbit and human IgG
- HRP labeled anti-human IgG
- Thermo Scientific Nunc MiniSorp Tubes
- Ortho-phenyl-diamine
- H<sub>2</sub>O<sub>2</sub>
- H<sub>2</sub>SO<sub>4</sub> 0.5 M

### Protocol

1. Pre-wash the plate with 3 x 300 µL/well PBST buffer.
2. Dilute biotinylated rabbit antihuman IgG 1:8000 in PBST buffer. Add 100 µL/well of the solution to the plate. Note: this dilution should be performed in a low-protein binding plastic tube (e.g. MiniSorp™).
3. Incubate the plate with gentle agitation for 1 hour at room temperature.
4. Aspirate the plate and wash three times with PBST buffer (3 x 300 µL/well).
5. Make a 1:2 titration of your human plasma sample. Prefill the appropriate wells with 100 µL of PBST. Starting with a 1:100 dilution of plasma in PBST, serially transfer 100 µL.
6. Incubate the plate with gentle agitation for 1 hour at room temperature.
7. Aspirate the plate and wash three times with PBST buffer (3 x 300 µL/well).
8. Prepare a 1:2000 dilution of HRP labeled secondary antibody

in PBST buffer. Add 100 µL/well to the plate. Note: this dilution should be performed in a low-protein binding plastic tube (e.g. MiniSorp).

9. Incubate the plate with gentle agitation for 1 hour at room temperature.
10. Aspirate the plate and wash three times with PBST buffer (3 x 300 µL/well).
11. Prepare a solution of orthophenylene-diamine (OPD), 6 mm; and H<sub>2</sub>O<sub>2</sub>, 4 mm in 100 mm citric acid buffer pH 5.0. Add 100 µL/well to the plate and incubate in the dark for 10 minutes at room temperature.
12. The enzyme reaction is stopped with H<sub>2</sub>SO<sub>4</sub>, 0.5 M (100 µL/well) and the absorbance is measured at 492 nm with an ELISA reader.

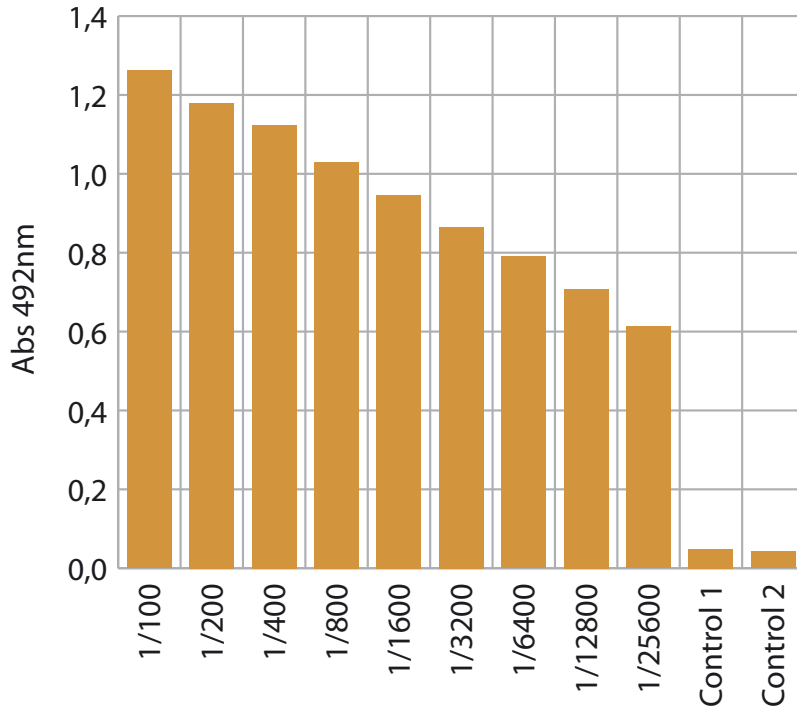
### Summary

The results show (Fig. 1) that an analyte, in this case human IgG, can be successfully and easily quantitated via a sandwich immunoassay that employs a biotinylated capture antibody and a streptavidin coated plate. In our example, the signal is proportional to the amount of plasma added to the well. The controls indicate that the signal is specific.

This assay is easy to perform. The plates were coated rapidly (1 hour), and a low background was observed even though no specific blocking step was employed. Immobilizer Streptavidin plates provide a flexible and sensitive immunoassay platform.

Fig. 1

### Measurement of Human IgG on Immobilizer Streptavidin plate

**Control 1**

without biotinylated antibody.

**Control 2**

without human plasma.

**Specifications: Clear 96 well plates**

- Streptavidin coated area; 100  $\mu$ L/well
- Total binding capacity for biotin, 5 ng/well (20 pmol/well)\*
- Stable at room temperature for 18 months after manufacturing
- Coefficient of variation (CV) < 5% well-to-well

\*The binding capacity may vary depending on the size and steric properties of the biotinylated biomolecule being used.

**References**

1. Koch T, Jacobsen N, Fensholdt J, Boas U, Fenger M, Jakobsen MH. Photochemical Immobilization of Anthraquinone Conjugated oligonucleotides and PCR Amplicons on solid Surfaces. *Bioconjugate Chem.* 11 (2000), 474-483.

**Credits**

Assay and protocol for Streptavidin plate preparation was designed by Kirsten Gerner-Smidt.

[www.thermoscientific.com/oemdiagnostics](http://www.thermoscientific.com/oemdiagnostics)

© 2010 Thermo Fisher Scientific Inc. All rights reserved. "Immobilizer" is a trademark of Exiqon A/S, Denmark. The product is produced under license from Exiqon A/S - EP 0820483 and foreign applications and patents; "Tween" is a registered trademark of Uniqema Americas; and "Dako" is a registered trademark of Dako Denmark A/S. All other trademarks are the property of Thermo Fisher Scientific Inc. and its subsidiaries.

# Thermo Scientific Nunc Immobilizer Streptavidin

## Application example: PCR ELISA

Thermo Scientific Nunc Immobilizer Streptavidin plates are manufactured using a patented photochemical method<sup>1</sup> for covalent coupling of ligands to polymer surfaces. Streptavidin, a high affinity biotin-binding protein isolated from *Streptomyces avidinii*, is covalently coupled via a polyethylene glycol spacer arm to the plate. The density, length and chemical composition of the spacer arms has been optimized to create a superior affinity surface. High signals, low non-specific binding and convenient room temperature storage are some of the benefits realized.

This note describes an easy and fast method for coupling biotinylated oligonucleotides to Nunc™ Immobilizer™ Streptavidin plates. We have demonstrated that the immobilized oligonucleotides are able to further hybridize in a specific manner with Digoxigenin (DIG) labeled PCR products.

### Introduction

PCR ELISA is a very sensitive analytical technique that utilizes nucleic acid hybridization and immunoassay methodology<sup>2,3,4</sup>. Streptavidin-coated wells facilitate the application by making it easy to prepare the requisite solid phase “capture probe” surface.

Briefly, one first amplifies a target DNA via PCR in which a hapten (e.g. digoxigenin) containing nucleotide is included in the reaction mixture. This produces amplified DNA products that are labeled with the hapten. The hapten labeled DNA is then denatured

and hybridized to a capture oligo that has been immobilized on an appropriate surface such as the surface of a microplate. A streptavidin coated plate to which the biotinylated oligo has been bound is a convenient and proven solid phase for this. After washing, the hybridized hapten labeled DNA is detected using a labeled (enzyme) anti-hapten antibody. The amount of bound labeled antibody is directly proportional to the amount of target DNA present in the original sample.

The example given demonstrates how the Immobilizer Streptavidin plate can be used to carry out this type of assay. In this model system, we show how target DNA, plasmid pUC 19 DNA<sup>5</sup>, can be detected. The assay utilizes a streptavidin plate to which biotin labeled capture probe has been immobilized. The capture probe is a biotinylated oligo that is complementary to pUC. Target DNA (pUC DNA) is amplified via PCR using a digoxigenin containing nucleotide in the reaction mixture. The digoxigenin nucleotide is incorporated and the resulting hapten labeled PCR products are subsequently denatured and hybridized to the solid phase capture probe. Finally the bound hapten labeled amplified DNA is detected using HRP labeled anti-digoxigenin.

### Materials

- Immobilizer Streptavidin LockWell™ module plate, clear
- 5 x SSCT, pH 7.0 (5 x SSC (750 mm NaCl, and 75 mm

- Sodium Citrate) containing 0.05% (v/v) Tween 20)
- 2 x SSCT, pH 7.0 (2 x SSC (300 mm NaCl, and 30 mm Sodium Citrate) containing 0.05% (v/v) Tween 20)
- PBST, pH 7.2 (Phosphate Buffered Saline containing 0.05% (v/v) Tween 20)
- Hybridization solution (50 mm Sodium-Phosphate buffer pH 7.0)
- Denaturation solution (125 mm NaOH)
- Biotinylated capture probe
- 3,3', 5,5' tetramethylbenzidine “TMB one” Ready to Use
- Sulphuric acid 0.5 M

### Procedure for coupling the biotinylated capture probe

1. Pre-wash the plate with 3 x 300 µL/well 5 x SSCT buffer. This is done to ensure improved sensitivity and high precision.
2. Prepare a solution of biotinylated capture probe in 5 x SSCT. We recommend a pre-optimization of the biotinylated capture probe concentration over the range of 0.01 to 0.5 µM.
3. Add the capture probe to the Immobilizer Streptavidin microplate/strip (100 µL/well).
4. Incubate the plate/strip with gentle agitation at room temperature for ≥30 min.
5. Aspirate the wells and wash with 2 x SSCT (3 x 300 µL/well).
6. The Immobilizer Streptavidin surface is now ready for the amplified target DNA sample.



### Amplification and denaturation of target

1. pUC DNA was PCR amplified using the following primers: 5' - AAC AGC TAT GAC CAT-3' and 5' - GTA AAA CGA CGG CCA GT 3' . The PCR labeling kit was used following the manufacturers instructions. The target DNA was amplified using the following program: 7 min. at 94°C; 35 cycles (94°C 1min.; 45°C 1 min.; 72°C 1 min.); and final elongation 72°C 10 min. The yield was estimated by agarose gel electrophoresis.
2. The PCR products were denatured as follows; 5 µL, 4 µL, 3 µL, 2 µL, 1 µL, 0.75 µL and 0.14 µL of PCR products were added to Thermo Scientific Nunc MiniSorp tubes and incubated with 10 µL of denaturation solution. The solutions were incubated for 5 min. and then 100 µL of hybridization solution was added. Each solution was mixed and 100 µL was transferred to each well of the capture probe coated streptavidin strip plate (see step 6 above).

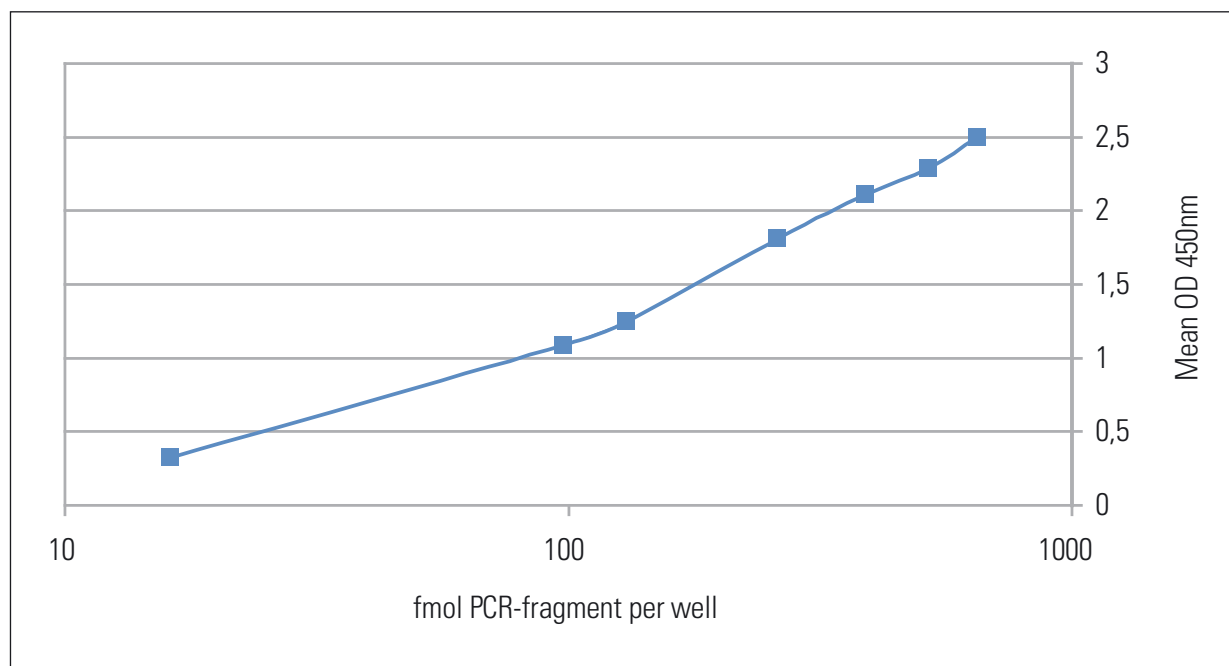
### Hybridization and immunological detection

1. The hybridization solution (see step 2 above) was allowed to incubate in the wells for 60 min. at 37°C with gentle agitation.
2. The strips were aspirated and washed three times with 2 x SSCT buffer which was preheated to +37°C.
3. HRP-anti DIG, Fab fragment diluted 1:1000 in PBST were added to the strips (100µL/well). Note: This dilution was prepared in low-protein binding tubes.
4. The strips were incubated with gentle agitation at room temperature for 30 min.
5. The strips were aspirated and washed three times with PBST solution (3 x 300 µL/well).
6. TMB solution was added to the strips (100 µL/well) and incubated, in the dark, at room temperature for 10 min.
7. The enzyme reaction was stopped with H<sub>2</sub>SO<sub>4</sub>, 0.5 M (100 µL/well). The absorbance was measured at 450 nm using an ELISA reader.

### Summary

The results show that the Immobilizer Streptavidin plate is an excellent solid phase for carrying out a PCR ELISA test. Using this unoptimized assay, the magnitude of the signal is seen to be directly proportional to the amount of PCR fragment added to the well (see Fig. 1). Less than 100 fmol ( $1 \times 10^{-13}$  mol) per well could be easily detected. A low non-specific binding signal of 0.05 OD unit was observed in the assay even though no blocking procedure was used. Although PCR ELISA utilizes an antibody for signal generation, assays that employ directly labeled probes can be similarly performed.

Fig. 1



### Specifications

- Streptavidin coated area ~100  $\mu$ L per well 96 well clear plate
- Total binding capacity for free biotin 5 ng/well (20 pmol/well)\*
- Stable at room temperature for 18 months after manufacturing
- Coefficient of variation (CV) < 5% from well to well

\*The binding capacity may vary depending on the size and steric properties of the biotinylated biomolecule being used.

### References

- 1) Koch T, Jacobsen N, Fensholdt J, Boas U, Fenger M, Jakobsen MH. Photochemical Immobilization of Anthraquinone Conjugated oligonucleotides and PCR Amplicons on solid Surfaces. *Bioconjugate Chem.* 11 (2000), 474-483
- 2) Garcia L, Alonso-Sanz M, Rebollo MJ, Tercero JC, Chaves F. Mutations in the rpoB gene of rifampin-resistant Mycobacterium tuberculosis isolates in Spain and the rapid detection by PCR-enzyme-linked immunosorbent assay. *J Clin Microbiol* (2001), 39(5):1813-1818

- 3) Munch M, Nielsen LP, Handberg KJ, Jorgensen PH. Detection and subtyping (H5 and H7) of avian type A influenza virus by reverse transcription-PCR and PCR ELISA. *Arch Virol* (2001), 146 (1):87-97
- 4) Shamloul AM, Abdallah NA, Madkour MA, Hadidi A. Sensitive detection of the Egyptian species of sugarcane streak virus by PCR-probe capture hybridization (PCR ELISA) and its complete nucleotide sequence. (2001)
- 5) pUC 19 accession no: VB0026
- 6) Yanisch-Perron C, Vieira J, Messing J, Improved M13 phage cloning vectors and host strains: nucleotide sequences of the M13mp 18 and pUC 19 vectors. *Gene*, (1985) 33:103-119

### Credits

Assay and protocol for Streptavidin plate preparation was designed by Kirsten Gerner-Smidt.

[www.thermoscientific.com/oemdiagnostics](http://www.thermoscientific.com/oemdiagnostics)

© 2010 Thermo Fisher Scientific Inc. All rights reserved. "Immobilizer" is a trademark of Exiqon A/S, Vedbaek, Denmark. The product is produced under license from Exiqon A/S - EP 0820483 and foreign applications and patents; "Tween" is a registered trademark of Uniqema Americas; and "PCR" is a registered trademark of Roche Molecular Systems Inc. All other trademarks are the property of Thermo Fisher Scientific Inc. and its subsidiaries.

# Thermo Scientific Nunc Immobilizer Glutathione

Thermo Scientific Nunc Immobilizer Glutathione plate is manufactured using a patented photochemical method<sup>1</sup> for covalent coupling of ligands to polymer surfaces via a spacer. The Nunc™ Immobilizer™ Glutathione MicroWell™ plates are designed for optimal binding of glutathione-S-transferase (GST)-tagged proteins.

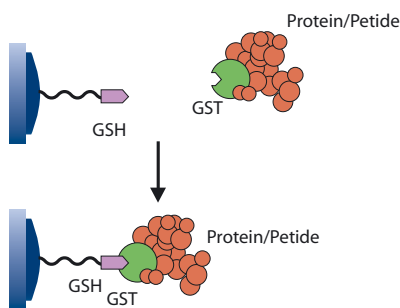
## Recommended coupling protocol

### Materials

- Immobilizer Glutathione MicroWell plates
- Coupling buffer: PBS (Phosphate Buffered Saline), pH 7.2
- Washing buffer: PBST (Phosphate Buffered Saline containing 0.05% (v/v) Tween 20).

### Protocol for 96 well plates

1. Prepare a solution of purified GST or a GST-tagged protein (0.001-1 µg/mL) in PBS. NB! Do not whirl mix.
2. Add the protein solution to the wells of the Immobilizer Glutathione plate (100 µL/well).



**Fig. 1.**  
Coupling of a GST-tagged protein/peptide to the Immobilizer Glutathione plate

3. Incubate with gentle agitation (100 rpm) at room temperature for two hours or overnight at +4°C.
4. Aspirate the wells and wash with PBST (3 x 300 µL).

### Protocol for 384 well plates

1. Prepare a solution of purified GST or a GST-tagged protein (0.001-1 µg/mL) in PBS. NB! Do not whirl mix.
2. Add the protein solution to the wells of the Immobilizer Glutathione plate (50 µL/well).
3. Incubate the plate with gentle agitation (100 rpm) at room temperature for two hours or overnight at +4°C.
4. Aspirate the wells and wash with PBST (3 x 100 µL).

It is not necessary to block the plates. During the coupling of GST (step 1, 2 and 3 of the protocols) non-ionic detergents like Tween 20 should NOT be present, as these will decrease the coupling of purified GST or GST-tagged fusion proteins.

It is recommended to include small amounts of a non-ionic detergent like Tween 20 (0.05% (v/v)) in washing buffers and in buffers for dilution of antibodies (e.g. anti-GST, antibodies against the fusion protein, secondary antibodies), as this generally improves the signal to noise ratio of the assay.

### Application example

#### Assay for determination of a GST-tagged fusion protein

Performance of Immobilizer Glutathione plates is illustrated using the transparent 96 well plate.

The Immobilizer Glutathione plate is ready to use. A GST-tagged fusion protein (56 kDa) is applied to the plate in a series of dilutions. The amount of immobilised GST-tagged fusion protein is detected by addition of an antibody against GST conjugated to horseradish peroxidase (HRP).

The amount of HRP is measured by addition of a substrate/chromogen (e.g. TMB). The color development based on the enzyme activity of the HRP is proportional to the amount of immobilised GST.

The reaction is stopped by adding stop solution (e.g. 1 N H<sub>2</sub>SO<sub>4</sub>).

The following assay is performed on the Immobilizer Glutathione plate.

#### GST-tagged fusion protein determination

1. Prepare a series of GST-tagged fusion protein solutions in PBS (0.005-0.05 µg/mL).
2. Dispense 100 µL of each of these solutions into the wells of a transparent Immobilizer Glutathione plate rows 1-10. PBS is added to rows 11-12 as negative controls.
3. Incubate the plate with gentle agitation (100 rpm) at room temperature for two hours.

4. Aspirate the wells and wash with PBST (3 x 300  $\mu$ L).
5. Add an anti-GST antibody or an antibody against the fusion protein diluted in PBST to the plate (100  $\mu$ L/well) to rows 1-11. PBST is added to row 12 as a negative control (result not shown).
6. Incubate the plate with gentle agitation (100 rpm) at room temperature for one hour.
7. Aspirate the wells and wash with PBST (3 x 300  $\mu$ L).
8. If the antibodies are not conjugated with HRP, an appropriate HRP conjugated antibody must be added.
9. Incubate the plate with gentle agitation (100 rpm) at room temperature for one hour.
10. Aspirate the wells and wash with PBST (3 x 300  $\mu$ L).
11. Add TMB solution to the plate (100  $\mu$ L/well).
12. Incubate the plate for 10 minutes in the dark.
13. Add 1 N H<sub>2</sub>SO<sub>4</sub> to the plate (100  $\mu$ L/well).
14. Read the absorbance at 450 nm.

As can be seen in Fig. 2, the background is extremely low using the Immobilizer Glutathione plate. This results in a high signal to noise ratio and a low detection limit, which in this example is 3 ng GST-tagged fusion protein per mL (0.3 ng/well) assuming OD cut off value of 0.5.

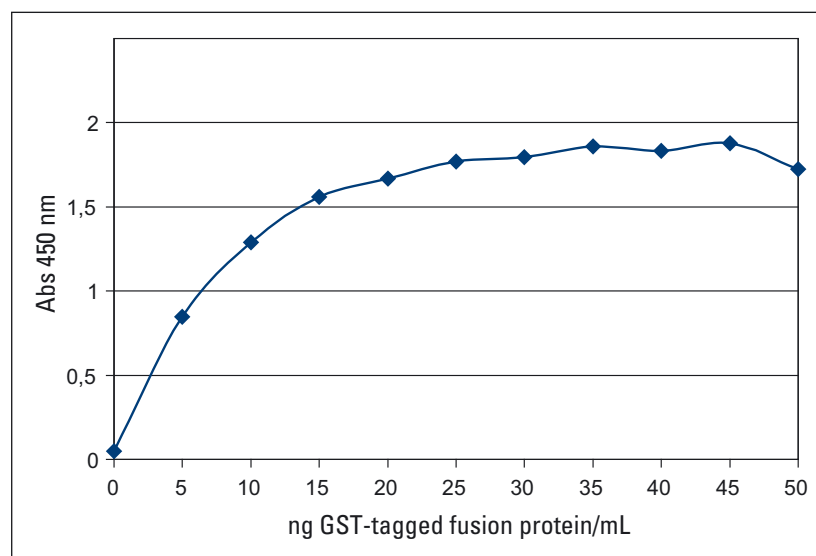
Furthermore, the assay time is very short on the Immobilizer Glutathione plate for detection of GST-tagged fusion proteins. This is due to fewer incubation steps in the assay (e.g. omitting the blocking steps).

#### Credits

Assay and protocol for Glutathione plate preparation was designed by Eva Jauho.

#### References

1. Jensen SP, Rasmussen SE, Jakobsen MH. Photochemical Coupling of Peptides to Polystyrene MicroWell Plates. *Innovations & Perspectives in Solid Phase Synthesis & Combinatorial Chemical Libraries* (1996), 419-422.



**Fig. 2.**

Dilution of a GST-tagged fusion protein (56 kDa) in PBS.

[www.thermoscientific.com/oemdiagnostics](http://www.thermoscientific.com/oemdiagnostics)

© 2010 Thermo Fisher Scientific Inc. All rights reserved. "Immobilizer" is a trademark of Exiqon A/S, Vedbaek, Denmark. The product is produced under license from Exiqon A/S - EP 0820483 and foreign applications and patents. "Tween" is a registered trademark of Uniqema Americas. All other trademarks are the property of Thermo Fisher Scientific Inc. and its subsidiaries.

# Detection of glutathione-S-transferase (GST) and GST-tagged fusion (F-protein)

The Thermo Scientific Nunc Immobilizer Glutathione plates are designed for optimal binding of GST and GST-tagged F-proteins.

No purification of GST-tagged fusion proteins is needed. Detection limit is very low.

The functional glutathione surface is based on patented technology for covalent coupling of ligands to polymer surfaces<sup>1</sup> via a spacer.

## Principle of the GST detecting assay

No blocking steps are required prior to addition of GST or detecting antibody.

The GST/GST-tagged fusion protein (F-protein) detection assay is conducted as follows:

- Purified GST or GST-tagged F-protein is applied to the plates. It is recommended to include controls without GST.
- The plates are incubated and subsequently washed to remove unbound proteins.
- The bound concentrations of the GST are detected as follows:
  1. addition of an enzyme conjugated antibody against GST or the protein part of the GST-tagged F-protein, or
  2. addition of an antibody against GST or the F-protein followed by addition of an enzyme conjugated antibody against the anti-GST or the F-protein antibody.
- The plates are incubated and subsequently washed to remove unbound proteins after each antibody application.
- The amount of bound enzyme (i.e. bound enzyme

conjugated antibody) is visualized by addition of a chromogen/substrate solution.

The enzyme reaction is stopped by addition of stop solution.

- The enzyme reactivity of the plates is measured in an ELISA reader.

## Recommended protocol for the detection of His-tagged F-proteins

### Reagents and materials

- Nunc™ Immobilizer™ Glutathione plate
- Coupling buffer: PBS (Phosphate Buffered Saline) (pH 7.2)
- Washing buffer: PBST (Phosphate Buffer Saline (pH 7.2) containing 0.05% (v/v) Tween 20
- Chromogen/substrate: 3,3', 5,5' tetramethylbenzidine (TMB)
- Stop solution: Sulphuric acid 0.5 M

## Application examples

### Detection of GST-tagged F-proteins

The following assay was conducted:

- A GST-tagged F-protein (35 kDa) expressed in an unpurified cell lysate (100 µL/well) was applied to the Immobilizer Glutathione plates in ten concentrations in a 1:2 dilution series (dilutions from 2000 ng/mL to 3.9 ng/mL). A negative control without GST was also added to the plates.
- The plates were incubated for two hours at room temperature with gentle agitation (100 rpm).
- The plates were washed three times with 300 µL/well PBST.
- Anti-GST (100 µL/well) diluted 1:2000 in PBST was added to the plates.
- The plates were incubated for one

hour at room temperature with gentle agitation (100 rpm).

- The plates were washed three times with 300 µL/well PBST.
- TMB (100 µL/well) was added to the plates.
- The plates were incubated for 10 minutes at room temperature in the dark.
- The enzyme reaction was stopped with 0.5 M sulfuric acid (100 µL/well).
- The absorbance was read at 450 nm.

Fig. 1 illustrates the OD response from an 1:2 dilution curve of an unpurified GST-tagged F-protein applied to a Glutathione Immobilizer plate.

As seen in Fig. 1, the detection limit for an unpurified GST-tagged F-protein is very low. Assuming a cut-off OD value of 0.5, the detection limit is 1.5 ng/well.

Even when testing an unpurified preparation of a cell lysate using the Immobilizer Glutathione plates very small concentrations of GST-tagged F-proteins can be detected. In the control without GST-tagged F-protein the background is very low (OD value 0.046).

The GST-tagged F-protein was kindly provided by Dr. Karsten Kristiansen, Syddansk University, Odense, Denmark.

### Detection of GST

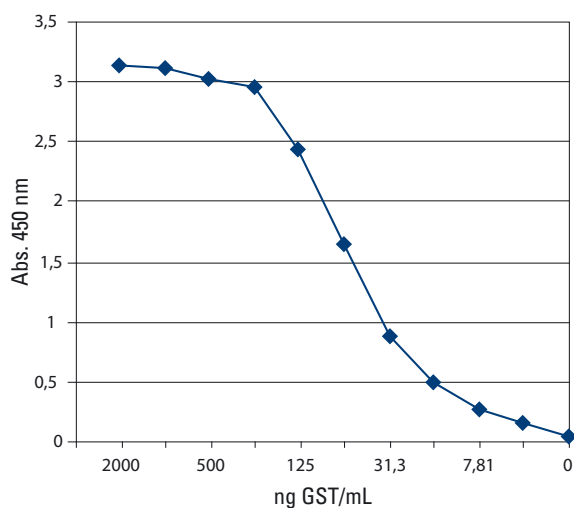
The following assay was conducted:

- Purified GST (100 µL/well) was added to the Immobilizer Glutathione plates at ten concentrations in a 1:2 dilution series (2000 ng/mL to 3.9 ng/mL).

A negative control without GST was also added to the plates.

- The plates were incubated for two hours at room temperature with gentle agitation (100 rpm).
- The plates were washed three times with 300  $\mu\text{L}$ /well PBST.
- Anti-GST (100  $\mu\text{L}$ /well) diluted 1:2000 in PBST was applied to the plates.
- The plates were incubated for one hour at room temperature with gentle agitation (100 rpm).
- The plates were washed three times with 300  $\mu\text{L}$ /well PBST.
- A chromogen/substrate solution TMB (100  $\mu\text{L}$ /well) was applied to the plates.
- The plates were incubated for 10 minutes at room temperature in the dark.
- The enzyme reaction was stopped with 0.5 M sulfuric acid (100  $\mu\text{L}$ /well).
- The absorbance was read at 450 nm.

Fig. 2 illustrates the OD response from a 1:2 dilution curve of purified GST applied to a Immobilizer Glutathione plate. Assuming a cut-off OD value of 0.5, the detection limit is 2.5 ng/well.



**Fig. 1.** Detection of a GST-tagged fusion protein from an unpurified cell lysate. The GST-tagged fusion protein was applied in 1:2 dilutions from 2000 ng/mL to 3.91 ng/mL. As a negative control, buffer without GST-tagged fusion protein was applied.

The detection limit for purified GST is thus very low. As seen from the control without GST the background is also very low (OD value 0.045).

#### Reproducibility of the Glutathione Immobilizer MicroWell plates

Four Glutathione Immobilizer plates (two different plate batches A and B) were tested. Purified GST was applied to the plates in different dilutions.

#### Assay procedure 96 well transparent plates

- Purified GST or GST-tagged F-proteins (100  $\mu\text{L}$ /well) is applied to the Glutathione Immobilizer plates in concentrations from 300 ng/mL to 30 ng/mL. A control without GST is also applied to the plates.
- The plates are incubated for two hours at room temperature with mild agitation (100 rpm).
- The plates are washed three times with 300  $\mu\text{L}$ /well PBST.
- Anti-GST (100  $\mu\text{L}$ /well) diluted 1:2000 in PBST is applied to the plates.
- The plates are incubated for one hour at room temperature with mild agitation (100 rpm).

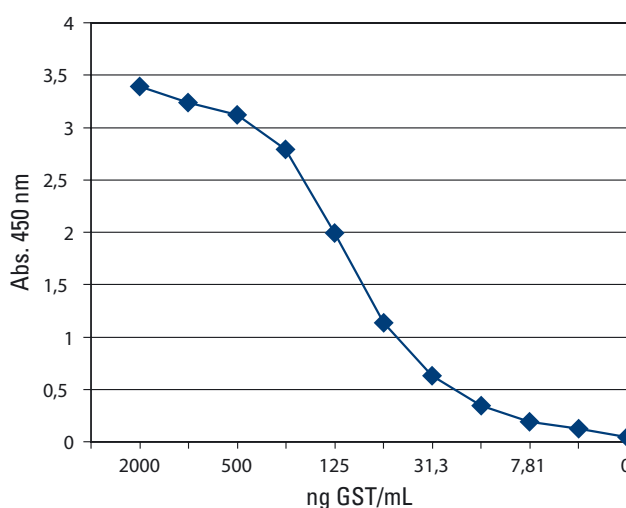
- The plates are washed three times with 300  $\mu\text{L}$ /well PBST.
- TMB (100  $\mu\text{L}$ /well) is applied to the plates.
- The plates are incubated for 10 minutes at room temperature in the dark.
- The enzyme reaction is stopped with 0.5 M sulfuric acid (100  $\mu\text{L}$ /well).
- The absorbance was read at 450 nm using an ELISA reader.

Fig. 3 illustrates the OD response from four dilution curves of purified GST applied to four Immobilizer Glutathione plates.

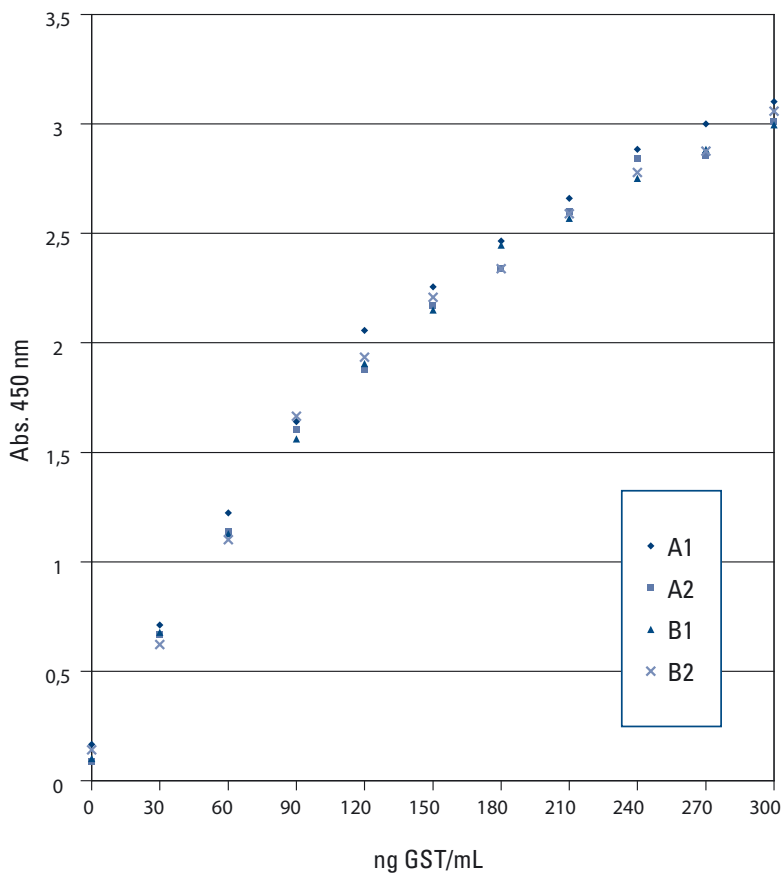
As seen in Fig. 3, the performance of the plates shows very little variation.

#### Features and benefits of the Immobilizer Glutathione plates

- No steric hindrance for GST-tagged fusion proteins.
- No blocking or activation steps needed.
- No purification of GST-tagged fusion proteins needed.
- Short assay time (3½ hours).
- Low detection limits.
- To date we can document nine month stability at 20-25°C.



**Fig. 2.** Detection of purified GST. Purified GST was added in 1:2 dilutions from 2000 ng/mL to 3.91 ng/mL. As a negative control, buffer without GST was applied.

**Fig. 3.**

Four Immobilizer Glutathione plates from two different plate batches (A and B) were tested. Purified GST was applied to the plates in the indicated concentrations.

### Credits

Assay and protocol for Glutathione plate preparation was designed by Eva Jauho, Betina Jacobsen and Maria Nielsen.

### References

- Jensen SP, Rasmussen SE, Jakobsen MH. Photochemical Coupling of Peptides to Polystyrene MicroWell Plates. *Innovations & Perspectives in Solid Phase Synthesis & Combinatorial Chemical Libraries* (1996), 419-422.
- Jacobsen MH, Koch T. Method of photochemical immobilization of ligands using quinones. WO 96/31557.

### References where covalent binding methods have been used

#### CovaLink

- Krook M et al. Novel peptides binding to the Fc-portion of immunoglobulins obtained from a combinatorial phage display peptide library. *J. Imm. Meth.*, 221:151-157.

#### Stadler S et al.

- Monoclonal anti-acid-labile subunit oligopeptide antibodies and their use in a two-site immunoassay for ALS measurement in humans. *J. Imm. Meth.* (2001), 252:73-82.

#### Immobilizer

- Davidson EJ et al. Human papillomavirus type 16 E2- and L1-specific serological and T-cell responses. *J. Gen. Virol.* (2003), 84:2089-2097.

#### Barend Bouma et al.

- Glycation Induces Formation of Amyloid Cross-Structure in Albumin. *J. Biol. Chem.* (2003), 278:41810-41819.

#### Nigel M. Page et al.

- Characterization of the endokinins: Human tachykinins with cardiovascular activity. *PNAS* (2003), 100:6245-6250.

#### Siao Ping Tsai et al.

- Nucleic acid capture assay, a new method for direct quantitation of nucleic acids. *Nucleic Acids Research* (2003), Vol. 31, No. 6, e25.

#### Irene Jauho E, Havsteen Jakobsen M.

- Rare cell isolation using antibodies covalently linked to slides: application to fetal cells in maternal blood. *Prenat. Diagn.* (2003), 23 (11):898-900.

www.thermoscientific.com/oemdiagnostics

© 2010 Thermo Fisher Scientific Inc. All rights reserved. "Immobilizer" is a trademark of Exiqon A/S, Vedbaek, Denmark. The product is produced under license from Exiqon A/S - EP 0820483 and foreign applications and patents. "Tween" is a registered trademark of Uniqema Americas. All other trademarks are the property of Thermo Fisher Scientific Inc. and its subsidiaries.

# Thermo Scientific Nunc Immobilizer Nickel-Chelate

Thermo Scientific Nunc Immobilizer Ni-Chelate plate is manufactured using a patented photochemical method 1 for covalent coupling of ligands to polymer surfaces. A Ni-Chelate complex is coupled via a spacer to the plates.

The Nunc™ Immobilizer™ Ni-Chelate plates are designed for optimal binding of fusion proteins that have been tagged with an amino acid sequence containing six consecutive histidine (His) molecules.

## Recommended coupling protocol

### Materials

- Immobilizer Ni-Chelate plates
- Coupling buffer: 0.01 M KCl
- Washing buffer: PBST (Phosphate Buffered Saline (pH 7.3) containing 0.05% (v/v) Tween 20)

### Protocol for 96 well plates

1. Pre-wash the plates with PBST (3 x 300 µL/well).
2. Prepare a solution of a 6 x His-tagged protein (0.01-1 µg/mL) in 0.01 M KCl.
3. Add the protein solution to the wells of the Immobilizer Ni-Chelate plate (100 µL/well).
4. Incubate the plate with gentle agitation (100 rpm) at 20-25°C for two hours or at +4°C overnight.
5. Aspirate the wells and wash with PBST (3 x 300 µL).

### Protocol for 384 well plates

1. Pre-wash the plate with PBST (3 x 100 µL/well).
2. Prepare a solution of a His-

tagged protein (0.01-1 µg/mL) in 0.01 M KCl.

3. Add the protein solution to the wells of the Immobilizer Ni-Chelate plate (50 µL/well).
4. Incubate the plate with gentle agitation (100 rpm) at 20-25°C for two hours or at +4°C overnight.
5. Aspirate the wells and wash with PBST (3 x 100 µL).

We recommend the inclusion of small amounts of a non-ionic detergent like Tween 20 (0.05% (v/v)) in washing buffers and in buffers for dilution of antibodies (e.g. antibodies against the fusion protein, secondary antibodies), as this generally improves the signal to noise ratio of the assay.

### Application example Assay for determination of a His-tagged fusion protein

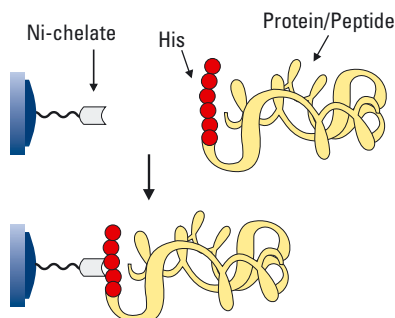
The performance of the Immobilizer Ni-Chelate surface is illustrated using the transparent 96 well plate.

A His-tagged fusion protein (25 kDa) is applied to the plate in a series of dilutions. The amount of immobilized His-tagged fusion protein is detected by addition of an antibody to the fusion protein. The antibody is conjugated to horseradish peroxidase (HRP). The amount of bound HRP is measured by addition of a substrate/ chromogen (e.g. TMB). The color development based on the enzyme activity of the HRP is proportional to the amount of immobilized 6 x His-tagged fusion protein.

The following assay was performed on the Immobilizer Ni-Chelate plate.

### His-tagged fusion protein determination

1. Pre-wash the plate with PBST (3 x 300 µL/well).
2. Prepare a series of His-tagged fusion protein solutions in 0.01 M KCl (0.001-0.5 µg/mL).
3. Dispense 100 µL of each of these solutions into the wells of a transparent Immobilizer Ni-Chelate plate in rows 1-10. Add 0.01 M KCl to rows 11-12 as a negative control.
4. Incubate the plate with gentle agitation (100 rpm) at 20-25°C for two hours.
5. Aspirate and wash the plate with PBST (3 x 300 µL).
6. Dispense 100 µL of an antibody to the fusion protein diluted in PBST to the wells of rows 1-11 on the plate. PBST is added to row 12 as a blank value.
7. Incubate the plate with gentle agitation (100 rpm) at 20-25°C for one hour.



**Fig. 1.** Coupling of a His-tagged protein/peptide to the Immobilizer Ni-Chelate plate.



8. Aspirate the wells and wash with PBST (3 x 300  $\mu$ L).
9. Incubate the plate with gentle agitation (100 rpm) at 20-25°C for one hour.
10. Aspirate the wells and wash with PBST (3 x 300  $\mu$ L).
11. Add TMB solution to the plate (100  $\mu$ L/well).
12. Incubate the plate for 10 minutes in the dark.
13. Add stop solution to the plate (100  $\mu$ L/well).
14. Read the absorbance at 450 nm.

As can be seen from Fig. 2, the background is extremely low when using the Immobilizer Ni-Chelate plate. This results in a high signal to noise ratio and a low detection limit, which in this assay is 15 ng His-tagged fusion protein per mL (1.5 ng/well) when assuming OD=0.5 as a significant response relative to the background.

Furthermore, the assay time is quite short on the Immobilizer Ni-Chelate plate for detection of His-tagged fusion proteins. This is due to the reduced number of incubation steps in the assay.

### Acknowledgements

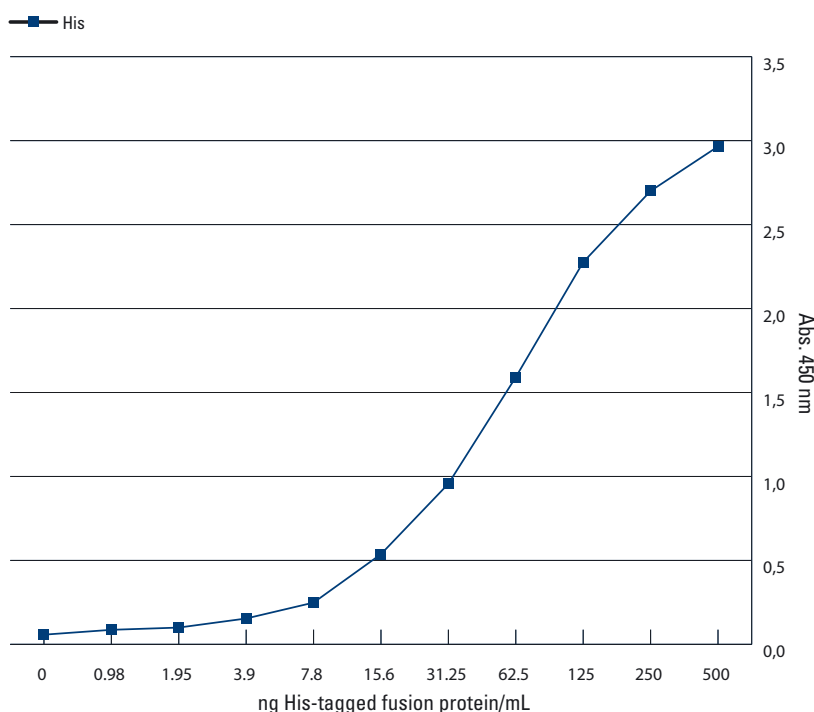
The His-tagged fusion protein was kindly provided by professor Søren Buus and Dr. Henrik Ferré, Institute for Medical Microbiology and Immunology, The Panum Institute, University of Copenhagen, Denmark.

### Credits

Assay and protocol for Ni-Chelate plate preparation was designed by Eva Jauho and Knud Lerstrup.

### References

1. Jensen SP, Rasmussen SE, Jakobsen MH. Photochemical Coupling of Peptides to Polystyrene MicroWell Plates. *Innovations & Perspectives in Solid Phase Synthesis & Combinatorial Chemical Libraries* (1996), 419-422.



**Fig. 2.**

Dilution of a His-tagged fusion protein (25 kDa) in 0.01 M KCl.

# Detection of His-tagged fusion proteins

The Thermo Scientific Nunc Immobilizer Ni-Chelate plates are designed for optimal binding of His-tagged fusion proteins without the need for purification prior to application.

Detection limit is very low. The functional Ni-Chelate surface is based on patented technology for covalent coupling of ligands to polymer surfaces<sup>1</sup> via a spacer.

Detection of histidine (His)-tagged fusion proteins on the Nunc™ Immobilizer™ Ni-Chelate plate compared with competitor plates.

## Recommended protocol for the detection of His-tagged fusion proteins

### Reagents and materials

- Immobilizer Ni-Chelate plate
- Coupling buffer: 0.01 M KCl
- Washing buffer: PBST (Phosphate Buffered Saline (pH 7.2) containing 0.05% (v/v) Tween 20)
- Chromogen/substrate: 3,3', 5,5' tetramethylbenzidine (TMB)
- Stop solution: Sulphuric acid 0.5 M

## Assay procedure 96 well transparent plates

- The plates are pre-washed three times with 300 µL/well PBST.
- Purified or crude His-tagged fusion protein (100 µL/well) is added to the Immobilizer Ni-Chelate plates in concentrations from 0.01 to 1 µg/mL. A control without His-tagged fusion protein is also included.
- The plates are incubated for two hours at room temperature with gentle agitation (100 rpm).

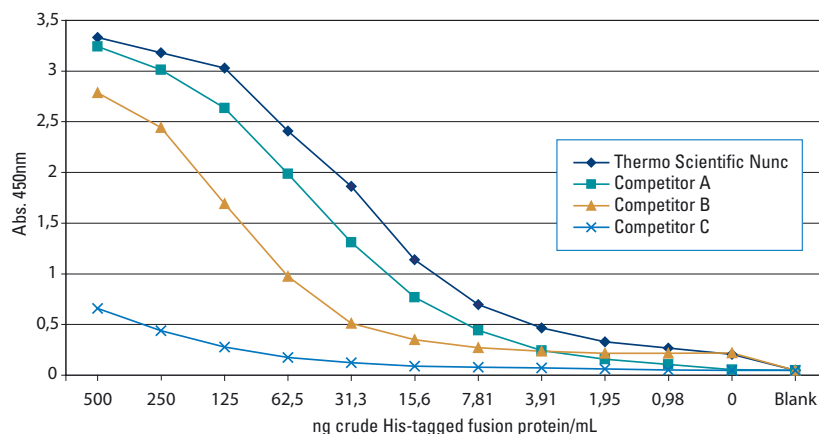
- The plates are washed three times with 300 µL/well PBST.
- Antibody against the fusion protein conjugated to horseradish peroxidase (HRP) (100 µL/well) diluted e.g. 1:5000 in PBST is added to the plates.
- The plates are incubated for one hour at room temperature with gentle agitation (100 rpm).
- The plates are washed three times with 300 µL/well PBST.
- TMB (100 µL/well) is added to the plates.
- The plates are incubated for 10 minutes at room temperature in the dark.
- The enzyme reaction is stopped with 0.5 M sulfuric acid (100 µL/well).
- The absorbance is read at 450 nm using an ELISA reader.

## Application example

A comparison of the performance of the Immobilizer Ni-Chelate plate and other commercially available plates was performed.

Three different preparations (A, B, C) of a fusion protein  $\beta$ -2-microglobulin ( $\beta$ -2-m 12 kDa) tagged with six His residues were tested.

- A crude preparation of  $\beta$ -2-m tagged with a sequential His tag (crude His- $\beta$ -2-m).
- A purified preparation of  $\beta$ -2-m tagged with a sequential His tag (purified His- $\beta$ -2-m).
- A purified preparation of  $\beta$ -2-m tagged with a non-sequential His tag (purified HAT- $\beta$ -2-m). The protein was tagged with a sequence of 20 amino acid, which included 6 histidines uniformly distributed throughout the sequence.



**Fig. 1.**

Detection of a His-tagged fusion protein from a crude cell lysate preparation (crude His- $\beta$ -2-m, preparation A). The His-tagged fusion protein was added in a 1:2 dilution to the plates. As a negative control, buffer without His-tagged fusion protein was added.

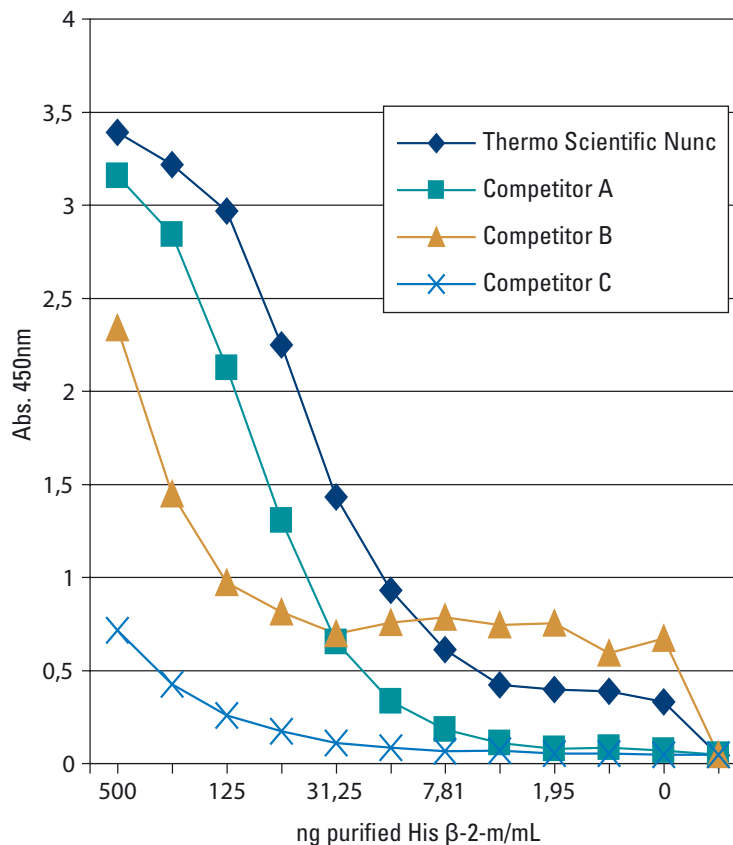
The following assay was conducted on the Immobilizer Ni-Chelate plate:

- The plates were pre-washed three times with 300  $\mu\text{L}$ /well PBST.
- A His-tagged fusion protein (A, B or C) was applied to the Immobilizer Ni-Chelate plates (100  $\mu\text{L}$ /well) in ten concentrations of a 1:2 dilution (500 ng–0.98 ng/mL).
- The plates were incubated for two hours at room temperature with gentle agitation (100 rpm).
- The plates were washed three times with 300  $\mu\text{L}$ /well PBST.
- Antibody against the fusion protein conjugated with HRP (HRP conjugated to anti- $\beta$ -2-m) diluted in PBST was added to the plates (100  $\mu\text{L}$ /well). The antibody was diluted to an appropriate concentration, here 1:5000.
- The plates were incubated for one hour at room temperature with gentle agitation (100 rpm).
- The plates were washed three times with 300  $\mu\text{L}$ /well PBST.
- TMB (100  $\mu\text{L}$ /well) was added to the plates.
- The plates were incubated for 10 minutes at +20-25°C in the dark.
- The enzyme reaction was stopped with 0.5 M sulfuric acid (100  $\mu\text{L}$ /well).
- The absorbance was read at 450 nm.

The assays on the competitor plates were performed using the protocol supplied by the different competitors.

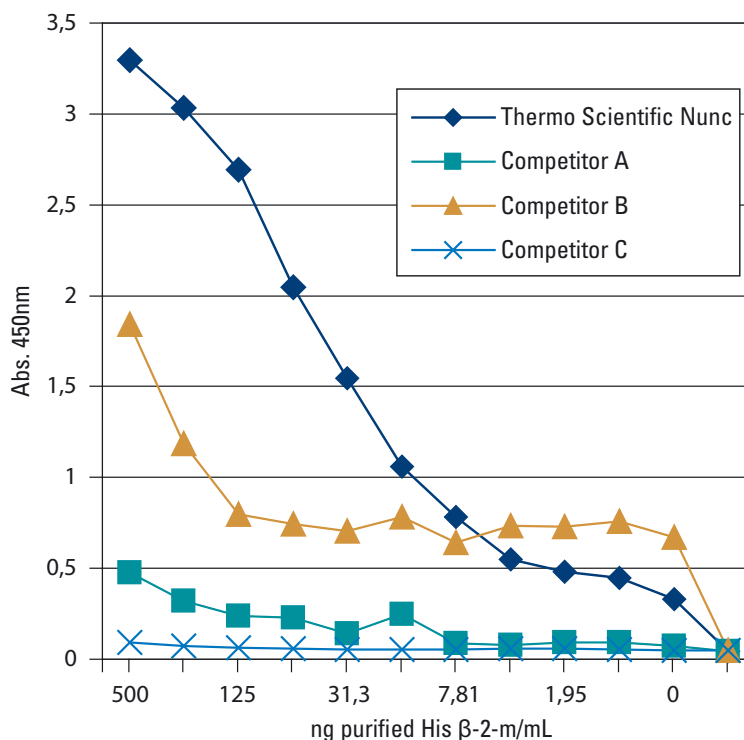
Figs. 1 and 2 illustrate the OD response of a 1:2 dilution curve of the same fusion protein (crude His- $\beta$ -2-m or purified His- $\beta$ -2-m) applied to a Immobilizer Ni-Chelate plate, as well as to plates from competitors A, B and C.

As seen in Figs. 1 and 2 the performance of the Immobilizer Ni-Chelate plate is superior to the performance of the competitor plates regardless of the degree of purification of the His-tagged fusion protein.



**Fig. 2.**

Detection of a purified His-tagged fusion protein (purified His- $\beta$ -2-m, preparation B). The His-tagged fusion protein was applied in a 1:2 dilution to the plates. As a negative control, buffer without His-tagged fusion protein was applied.



**Fig. 3.**

Detection of the fusion protein tagged with a non-sequential histidine tag (purified HAT- $\beta$ -2-m, preparation C). The purified HAT- $\beta$ -2-m was added in a 1:2 dilution to the plates. As a negative control, buffer without His-tagged fusion protein was added.

Even when testing an unpurified preparation of a cell lysate using the Immobilizer Ni-Chelate plates, very small concentrations of His-tagged fusion protein (0.5 ng per well) can be detected assuming an OD cut off value of 0.5.

Fig. 3 illustrates a 1:2 dilution curve of the fusion protein tagged with a non-sequential His tag (purified HAT- $\beta$ -2-m, preparation C). The purified HAT- $\beta$ -2-m was applied to a Immobilizer Ni-Chelate plate, as well as to plates from competitors A, B and C. As seen in Fig. 3, the performance of the Immobilizer Ni-Chelate plate is superior to the performance of the competitor plates.

### Conclusion

As seen from Figs. 1 to 3, the Immobilizer Ni-Chelate plate shows a higher OD response when compared to the competitor plates. Also the calculated CV% is lower on the Immobilizer Ni-Chelate plate than on many competitor plates (data not shown).

This finding is true regardless of the histidine tagged fusion protein used (His in sequence or in a non-sequential distribution as

well as a crude preparation of the His-tagged fusion protein).

Even when a fusion protein is tagged with a non-sequential His tag (HAT- $\beta$ -2-m), the fusion protein binds equally well to the immobilizer Ni-Chelate plate. Using the competitor plates the HAT- $\beta$ -2-m does not bind as well as the His- $\beta$ -2-m.

### Acknowledgements

The His-tagged fusion proteins were kindly provided by Professor Søren Buus, Institute for Medical Microbiology and Immunology, Copenhagen University, Denmark.

### Credits

Assay and protocol for Ni-Chelate plate preparation was designed by Eva Jauho and Maria Nielsen.

### References

1. Jensen SP, Rasmussen SE, Jakobsen MH. Photochemical Coupling of Peptides to Polystyrene MicroWell Plates. *Innovations & Perspectives in Solid Phase Synthesis & Combinatorial Chemical Libraries* (1996), 419-422.
2. Jacobsen MH, Koch T. Method of photochemical immobilization of ligands using quinones. WO 96/31557.

### References where covalent binding methods have been used

#### CovaLink

Krook M et al. Novel peptides binding to the Fc-portion of immunoglobulins obtained from a combinatorial phage display peptide library. *J. Imm. Meth.*, 221:151-157.

Stadler S et al. Monoclonal anti-acid-labile subunit oligopeptide antibodies and their use in a two-site immunoassay for ALS measurement in humans. *J. Imm. Meth.* (2001), 252:73-82.

#### Immobilizer

Davidson EJ et al. Human papillomavirus type 16 E2- and L1-specific serological and T-cell responses. *J. Gen. Virol.* (2003), 84:2089-2097.

Barend Bouma et al. Glycation Induces Formation of Amyloid Cross-Structure in Albumin. *J. Biol. Chem.* (2003), 278:41810-41819.

Nigel M. Page et al. Characterization of the endokinins: Human tachykinins with cardiovascular activity. *PNAS* (2003), 100:6245-6250.

Siao Ping Tsai et al. Nucleic acid capture assay, a new method for direct quantitation of nucleic acids. *Nucleic Acids Research* (2003), Vol. 31, No. 6, e25.

Irene Jauho E, Havsteen Jakobsen M. Rare cell isolation using antibodies covalently linked to slides: Application to fetal cells in maternal blood. *Prenat. Diagn.* (2003), 23 (11):898-900.

[www.thermoscientific.com/oemdiagnostics](http://www.thermoscientific.com/oemdiagnostics)

©2010 Thermo Fisher Scientific Inc. All rights reserved. "Immobilizer" is a trademark of Exiqon A/S, Vedbaek, Denmark. The product is produced under license from Exiqon A/S - EP 0820483 and foreign applications and patents. "Tween" is a registered trademark of Uniqema Americas. All other trademarks are the property of Thermo Fisher Scientific Inc. and its subsidiaries.

# Thermo Scientific Nunc Immobilizer

## Glutathione and Nickel-Chelate

### Binding of tagged fusion proteins

Glutathione (GSH) is a tri-amino peptide, which is covalently attached to the polystyrene using unique surface chemistry. Via a simple one-step protocol it can bind with glutathione-S-transferase (GST)-tagged fusion proteins or purified GST. Thermo Scientific Nunc Immobilizer Glutathione can, for example, be used for the analysis of a cell lysate to determine the presence and concentration of a desired GST-tagged protein.

The Nunc™ Immobilizer™ Nickel-Chelate is a similar system that is designed for the determination of 6 x His-tagged fusion proteins. Both of these products can be used with crude extracts, as well as purified cell material.

In common with the other Immobilizer products, the placement of the reactive groups on a spacer allows interaction, even with large proteins, with very little to no steric hindrance.

### Common features

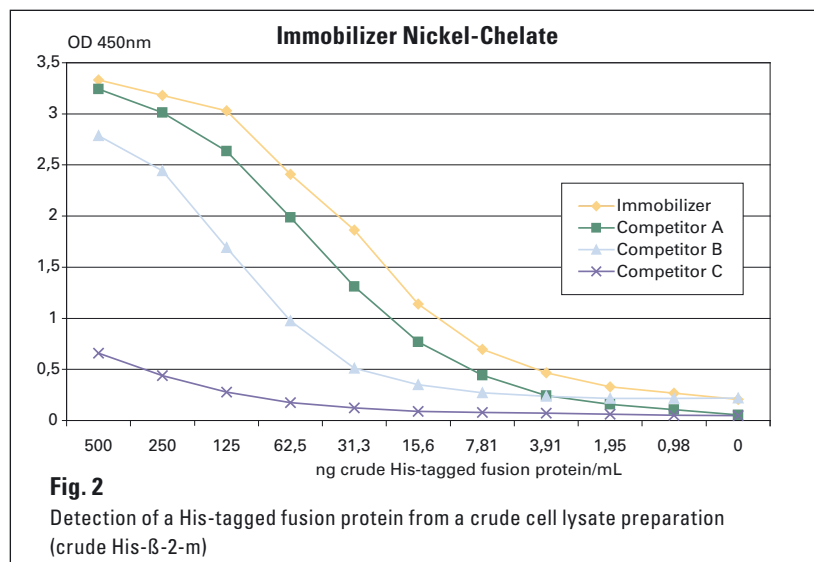
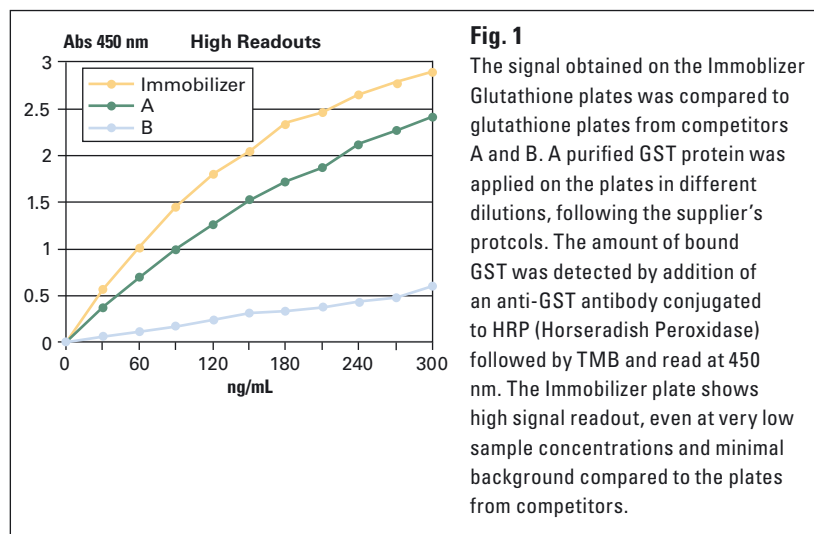
#### No blocking steps

The monolayer coating on the plates provides a hydrophilic surface that requires no subsequent blocking steps. Immobilizer surfaces are optimized to ensure minimal steric hindrance of binding. This is due to the hydrophilic linker that provides an optimal distance from the surface.

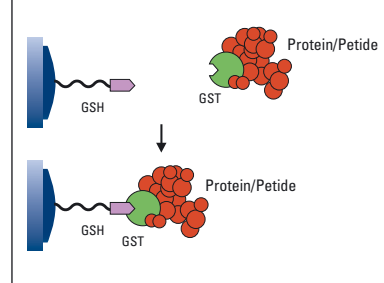
#### High signal to noise ratio

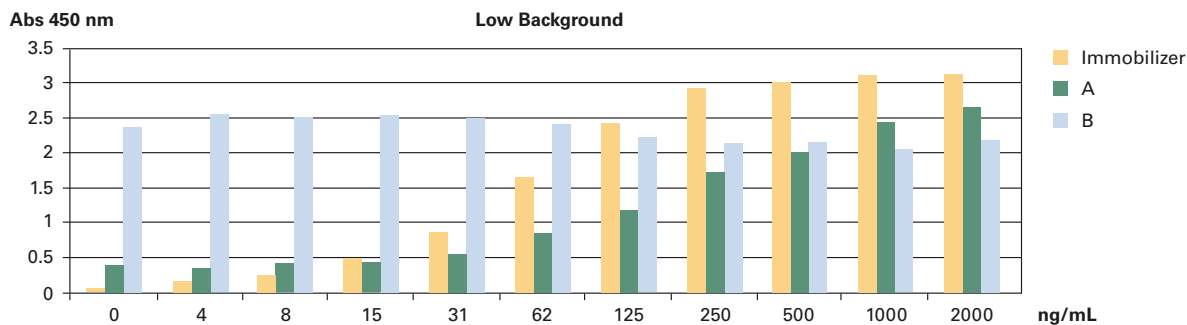
High signal readouts and low background (see Figs. 1 and 3) characterize the Immobilizer products even when testing low sample concentrations. These features enhance the sensitivity and specificity of the plates and in combination with no or very low non-specific binding, ensure superior signal to noise ratios.

As can be seen from Fig. 2, the detection limit is extremely low when using the Immobilizer Nickel-Chelate plate. This results in a detection limit, which in this assay is 4 ng 6 x His-tagged fusion protein per mL (0.4 ng/per well) when assuming OD = 0.5 as a significant response (cut off value) relative to the background.



### Mechanism of action Immobilizer Glutathione

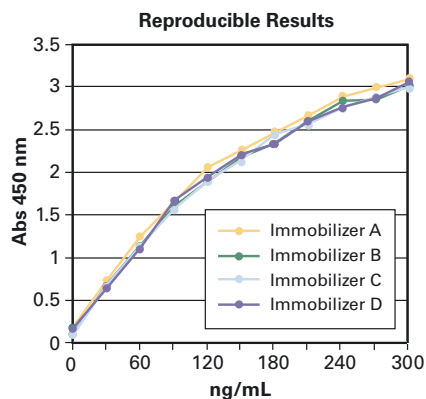


**Fig. 3**

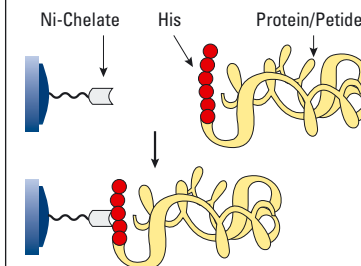
The figure shows the OD response of GST-tagged fusion protein applied to Immobilizer Glutathione, competitors A and B in different concentrations (following the protocols supplied). The amount of bound GST-tagged protein was detected with an anti-GST antibody conjugated to HRP (Horseradish Peroxidase) followed by TMB and read at 450 nm. The results show that the background is much lower on the Immobilizer plate than on the competitors plates. The Immobilizer Glutathione shows a very low detection limit for GST-tagged protein. The detection limit (OD = 1) for Glutathione Immobilizer is 40 ng/mL (4 ng/well, data on file) in this assay.

**Fig. 4**

Dilutions of purified GST tested on four different Immobilizer Glutathione plates (A, B, C and D) from two different batches. The amount of bound GST was detected by addition of an anti-GST antibody conjugated to HRP (Horseradish Peroxidase) followed by TMB and read at 450 nm.



#### Mechanism of action Immobilizer Nickel-Chelate



#### Very low detection limits

The recommended coupling protocols are extremely simple and the required concentrations of target molecule in the coupling buffer are usually low. The detection limit for GST-tagged protein, assuming a cutoff OD value of 0.5, is 1.5 ng/well (see Fig. 3). For Nickel-Chelate the detection limit, under the same assumption, is 0.4 ng/well.

#### Highly reproducible results

Assays conducted on the Immobilizer plates are characterized by high reproducibility (see Fig. 4). The covalently bound monolayer coating of the plates is highly uniform. This feature makes the Immobilizer plates the preferred choice in critical assay procedures.

[www.thermoscientific.com/oemdiagnostics](http://www.thermoscientific.com/oemdiagnostics)

© 2010 Thermo Fisher Scientific Inc. All rights reserved. "Immobilizer" is a trademark of Exiqon A/S, Vedbaek, Denmark. The product is produced under license from Exiqon A/S - EP 0820483 and foreign applications and patents. All other trademarks are the property of Thermo Fisher Scientific Inc. and its subsidiaries.

# Thermo Scientific Microtiter Streptavidin Coated Microplates

## Binding capacity and comparison with other commercial streptavidin coated microplates

LCP Research Group, Thermo Fisher Scientific

In this Technical Note we present the binding capacity of Thermo Scientific's streptavidin coated Microtiter microplates and a comparison to the binding capacity of competitors' streptavidin coated microplates. The uniformity of different manufacturing batches is presented by lot-to-lot binding CV% and lot-to-lot biotin binding capacity.

### Test method

200µL FITC-biotin solution (0.25nmol/mL) was added to streptavidin coated microplates. The microplates were incubated for 60 minutes at 37°C on a shaker (900rpm). 100µL of the FITC-biotin solution was transferred to a white Microtiter™ microplate and the fluorescence was measured on Thermo Scientific Fluoroskan using filter pair ex. 485nm/em. 538nm. The fluorescence was compared to that of a 0.25nmol/mL FITC-biotin solution that was added directly to the white microplate. In this way the amount of biotin bound to the streptavidin microplate could be determined. The results are expressed as pmol bound FITC-biotin/well.

To test the resistance of streptavidin coating for stringent washing conditions, half of the microplates was washed with a 0.1M NaOH solution, followed by washing steps with a PBS-Tween-buffer. The binding capacity was determined as described above.

### Results

The results of the binding capacity tests are summarized in Table 1. The binding capacity of Microtiter microplates was 25pmol/well and after washing with NaOH 23pmol/well. The binding capacity of the tested competitor's microplates were between 7-19pmol/well without NaOH-washing and between 5-15pmol/well after NaOH-washing.

The CV% and binding capacities in different manufacturing lots are shown in Figs. 1 and 2, respectively. Fig. 1 shows biotin binding CV% of 18 lots of Microtiter breakable strip microplates. Fig. 2 shows the binding capacity of Microtiter microplates without NaOH washing and after NaOH washing. The average binding capacity without NaOH washing step was 26pmol/well and after NaOH washing 23pmol/well.

	Binding capacity (pmol/well)	Binding capacity after NaOH treatment (pmol/well)
<b>Microtiter</b>	26	22
<b>Competitor 1</b>	15	14
<b>Competitor 2</b>	19	15
<b>Competitor 3</b>	7	5

Table 1. Average binding capacity of streptavidin coated clear microplates

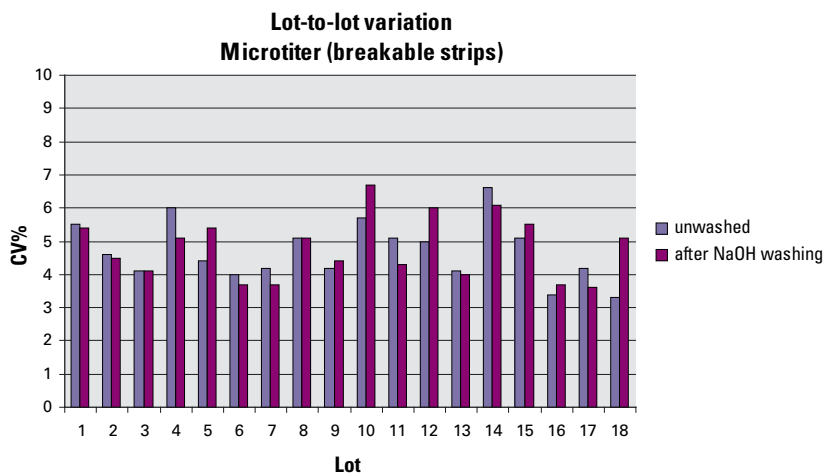


Fig. 1. Biotin binding CV% of 18 lots of Microtiter clear breakable strip microplates.

### Conclusions

Streptavidin coated Microtiter microplates showed a high binding capacity and an excellent lot-to-lot consistency. Stringent washing conditions had only a minor effect on the streptavidin coating.

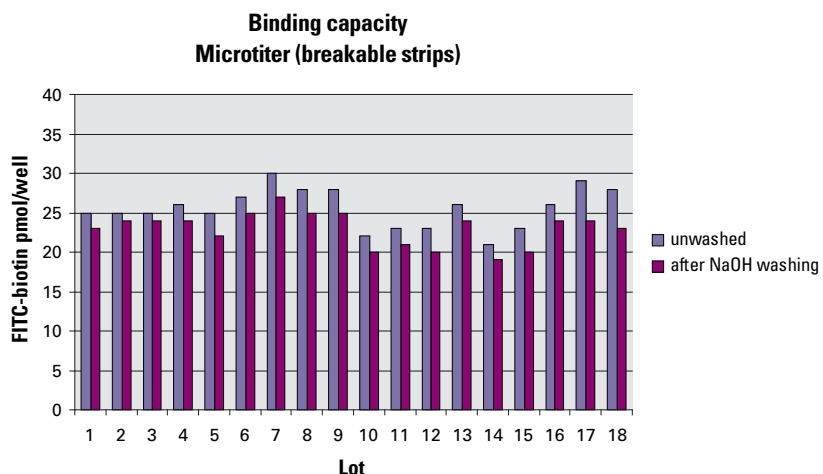


Fig. 2. Binding capacity of 18 lots of Microtiter clear breakable strip microplates.



# Thermo Scientific Microtiter Streptavidin Coated Microplates for PCR-ELISA

LCP Research Group, Thermo Fisher Scientific

This technical note provides a general protocol for performing PCR-ELISA analysis using Thermo Scientific Microtiter streptavidin coated microplates.

## Introduction

Streptavidin is a tetrameric protein, which can bind four biotins per one molecule; each monomer binds one molecule (Fig. 1)<sup>1</sup>. Biotin binds to streptavidin with a very high affinity ( $K_{\text{aff}} \sim 10^{13} \text{ M}^{-1}$ ).

Streptavidin coated Microtiter™ microplates can be used for binding of biotinylated molecules, including

- proteins
- peptides
- polysaccharides
- DNA / RNA

The molecules may be labeled with different labels and thereafter detected according to the label used either by colorimetric, luminometric or fluorometric methods. Thermo Fisher Scientific offers clear, white and black streptavidin coated Microtiter microplates for these different detection methods.

In this technical note a general protocol for PCR-ELISA is given.

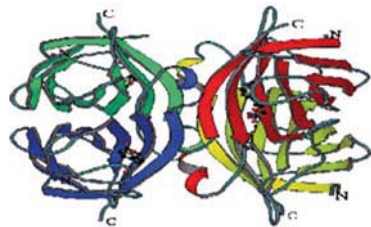


Fig. 1: Structure of streptavidin.

## What is PCR-ELISA?

PCR-ELISA is a capture assay for nucleic acids that mimics enzyme linked immunosorbent assay (ELISA). It uses an oligonucleotide capture probe that is labeled with

biotin and bound to a streptavidin coated microtiter microplate. The PCR product labeled e.g. with digoxigenin is added and the hybridized product (probe-PCR product) is detected and quantitated with an enzyme-conjugated anti-label antibody (e.g. anti-digoxigenin peroxidase).

PCR-ELISA's have been in use since the late 1980s and have developed into an assay for detecting specific sequences within PCR products. Though many methods are available for detecting specific sequences, PCR-ELISA is useful for detecting and differentiating between multiple targets<sup>2</sup>.

The assay is quick and sensitive and allows simultaneous testing of a large number of samples.

## General Protocol for PCR-ELISA

PCR-ELISA consists of the following steps:

1. Label the PCR products, e.g. with digoxigenin using a commercial kit. Denature the labeled PCR products, e.g. by adding 100µL per well of 0.5M NaOH. Incubate for 5-10 minutes.
2. Prepare the biotinylated oligonucleotide probe for addition onto streptavidin coated Microtiter microplate by diluting the reaction 1:10-1:50 in PBS + 0.05% Tween 20 surfactant.
3. Apply 50-200µL per well of the diluted probe and allow the sample to incubate for 15-60 minutes at 25-37°C.
4. Wash the wells three to six times, 300µL per well, with PBS + 0.05% Tween 20 surfactant.
5. Add 100-200µL per well of denaturated PCR products, 0.05-0.5pmol per well. Hybridize

in the presence of 3-5X SSC, 0.3% Tween 20 surfactant, 1% BSA. Allow the hybridization to proceed for 30 minutes up to two hours at 37-55°C.

6. Wash the wells three to nine times, 300µL per well, with PBS + 0.05% Tween 20 surfactant.
7. Add 100-150µL per well of an appropriately diluted detection conjugate (e.g. antidigoxigenin-Fab-peroxidase) in PBS + 0.05% Tween 20 surfactant. Incubate for 30-60 minutes at RT.
8. Wash the wells five to six times, 300µL per well, with PBS + 0.05% Tween 20 surfactant.
9. Add a specific substrate for the conjugate and perform the measurement.

Examples of PCR-ELISA protocols can be found from references 3, 4 and 5.

## Optimizing protocols

Important areas to concentrate on when optimizing the procedures are:

1. Non-specific binding  
Means of trying to reduce non-specific binding:
  - changing the conjugate concentration
  - modifying the washing buffers with components within the ranges suggested below (Table 1)
2. Washing conditions  
To reduce non-specific reversible binding at least three washing steps are recommended.
3. Antibodies and conjugates  
Commercially obtained conjugates should be used at the concentrations recommended by the supplier or alternatively they can be optimized for a particular assay.

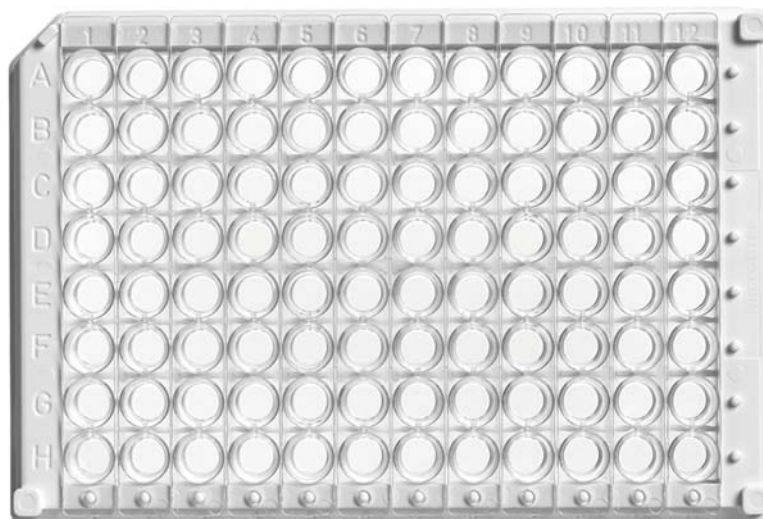
Detergents	0.05-0.1% Tween 20 surfactant, 0.002-0.05% Tween 65 surfactant
Salts	0.5-1.0M NaCl or Na <sub>2</sub> HPO <sub>4</sub>
Protein blockers	0.1-1% BSA or casein
Non-protein blockers	1% PEG 20 or Polyvinylpyrrolidone

Table 1. Washing buffer components

### Technical characteristics and handling

- The coated area is 200µL
- Binding capacity determined by FITC-biotin\* binding test is according to specifications  $\geq$  12pmol of FITC-biotin bound per well
- Storage at +4°C - +8°C
- Shelf lives: clear microplates 24, black microplates 29 and white microplates 26 months
- The microplates are ready to use

\*FITC = *Fluorescein Isothiocyanate*

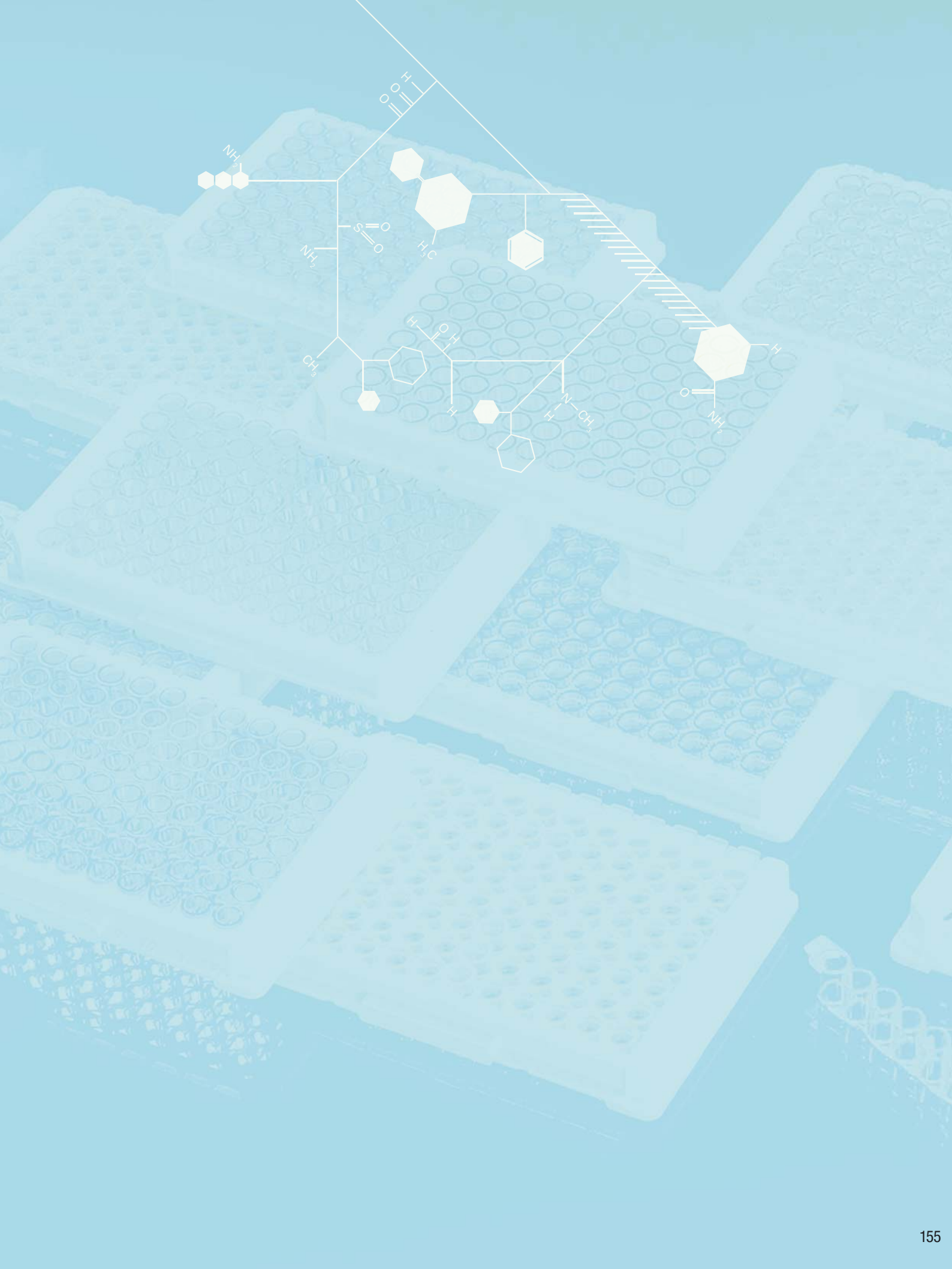


### References

1. <http://faculty.washington.edu/stenkamp/stefanieweb/abstract.html>
2. <http://www.btc-bti.com/pcrelisa.htm>
3. Garcia L, Alonso-Sanz M, Rebollo MJ, Tercero JC and Chaves F. Mutations in the rpoB gene of Rifampin-resistant Mycobacterium tuberculosis isolates in Spain and their detection by PCR-enzyme-linked immunosorbent assay. J. Clin. Microbiol. 2001; 39, 1813-1818.
4. Laitinen R, Malinen E and Palva A. PCR-ELISA I: Application to simultaneous analysis of mixed bacterial samples composed of intestinal species. System. Appl. Microbiol. 2002; 25, 241-248.
5. Malinen E, Mättö J, Salmitie M, Alander M, Saarela M and Palva A. PCR-ELISA II: Analysis of Bifidobacterium populations in human faecal samples from a consumptional trial with Bifidobacterium lactis Bb-12 and a galacto-oligosaccharide preparation. System. Appl. Microbiol. 2002; 25, 249-258.

www.thermoscientific.com

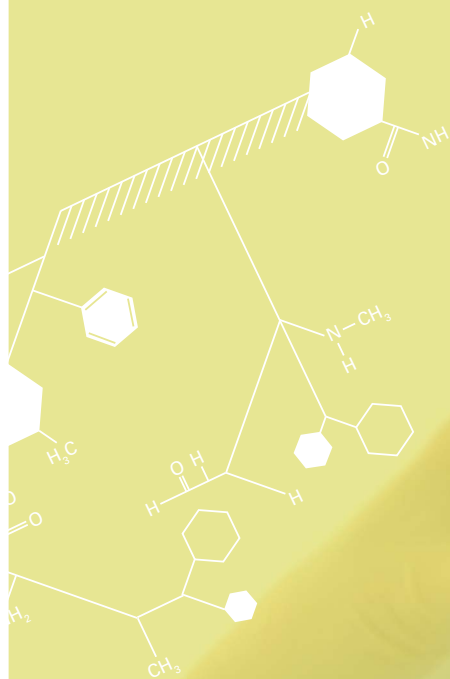
©2011 Thermo Fisher Scientific Inc. All rights reserved. "Tween" is a registered trademark of Uniqema Americas. All other trademarks are the property of Thermo Fisher Scientific Inc. and its subsidiaries.





# Appendix index

Appendix 1	
Pipetting/dispensing.....	157
Appendix 2	
Washing procedures.....	159
Appendix 3	
Readers.....	161
Appendix 4	
Capture, pre- and post-capture reagents.....	163
Appendix 5	
Hybridization Detection of PCR Products.....	168
Appendix 6	
Common reagent recipes.....	170





# Pipetting/dispensing

1. Pipettes
2. Dispensers
3. Typical problems
4. Calibration of pipettes and dispensers
5. Maintenance of pipettes and dispensers



## 1. Pipettes

The pipettes used in immunoassays are usually single, 8 and 12 channel pipettes with disposable tips. Usually, the pipettes have one piston per channel, i.e. multi-channel pipettes may be regarded as a number of individual pipettes in an array. Therefore it is necessary to calibrate each individual channel of a multi-channel pipette.

Disposable tips intended for identical volumes may vary in quality and size from brand to brand; therefore care should be taken when choosing tips. Different brands of pipettes may require different tips due to minor, but significant, differences in diameter and conicity.

## 2. Dispensers

Usually, automatic dispensers used for immunoassays dispense whole columns or rows, i.e. they are 8 or 12 channel dispensers. Other types of dispensers, single channel and whole plate (8 x 12) are not very common.

There are a number of different design principles for the automatic dispensers:

- a) One pump or piston for each channel. These types are considered the most reliable, especially those with displacement pumps.
- b) One pump for all channels and a manifold which distributes the dispensing liquid to a fixed number of channels. This type is considered less reliable as even a small restriction in the manifold may change the volume dispensed by one or more channels.
- c) Reservoir type where a reservoir is filled and the liquid dispensed by gravity through a number of needles. This type is considered the least precise and very sensitive to blockage/restrictions in the needles.

## 3. Typical problems

### Unexpectedly high or low readings

Problems due to the dispensing are most frequently rows or columns showing unexpectedly high or low readings. The cause of these problems may be one or more channels being permanently out of calibration, or tips/channels being partly blocked, usually by precipitated salt crystals or other particles. Other causes may be leaky pistons and/or improper fitting of the tips.

### Unexpectedly high variation in readings

Problems of this kind may be due to improper fitting of the tips, leaky pistons, and for automatic dispensers, a leakage in pump, tube connections or manifold. For automatic dispensers with rotating pump head the precision is dependent on the amount dispensed per turn of the pump, i.e. the precision is considered better if a smaller volume per turn is used.

### Unexpected low readings in a few wells

A problem which may be difficult to find is when the same pipette is used for dispensing of conjugate or substrate and acid, and the piston or tip bearing cone is contaminated by acid. The problem is commonly observed as random, unexpectedly lower readings, often in only a few wells. The cause of the problem is acid vapor in the piston. Acid dispensed together with the conjugate will reduce the enzyme activity and result in a lower reading. Severe acid contamination may affect even the substrate.

To check whether there is acid in pistons or bearings you should aspirate a few microliters of distilled water into tip bearing cone and dispense this on pH indicator paper.

## 4. Calibration of pipettes and dispensers

Pipette and dispenser accuracy is very important to the overall result of an immunoassay. Like other precision instruments, pipettes and dispensers should be frequently calibrated to secure faultless and precise function.

### Calibration by weighing

Calibrate pipettes and automatic dispensers by dispensing an identical volume into pre-weighed modules (in order to allow weighing of the output from a single channel, use 8 well modules for 12 channel dispensers and 12 well modules for 8 channel dispensers), i.e. a complete module per channel. From the weight of the dispensed liquid the average volume per stroke and channel to channel variation can be calculated. By using 8 well modules for 8 channel and 12 well modules for 12 channel the stroke to stroke variation can be calculated in a similar way.



### **Calibration by colorimetric reading**

Pipettes and dispensers can be calibrated by dispensing a colored solution into a 96 well plate and measuring the OD in a multi-channel photometer at the appropriate wavelength. By calculating the mean, standard deviation and coefficient of variation (CV) for each individual row, column, and entire plate you will automatically get the channel to channel variation, average volume per stroke, and stroke-to-stroke variation for each individual channel as well as the total variation of the pipette or dispenser.

## **5. Maintenance of pipettes and dispensers**

### **Daily maintenance**

Daily cleaning of pipettes and dispensers should be a standard routine to secure faultless and precise function and a prolonged lifetime.

Pipettes should always be taken apart and cleaned whenever it is suspected that bearings or pistons have been contaminated by the liquids dispensed, and they should never be left overnight with tips on.

Dispensers should always be cleaned thoroughly with distilled water after use, and, if possible, the dispensing head should be dried to avoid precipitation of and corrosion by salt in buffers or acids/bases from stopping solutions.

### **Preventive maintenance**

At regular intervals, depending on the use, pipettes should be taken apart and cleaned, pistons greased, and O-rings changed, if necessary. Tip bearing cones should be inspected for scratches and marks as they may lead to leaky tips.

Similarly, automatic dispensers should be inspected for damaged or worn-out tubing, leaky connectors, damaged and/or leaky manifolds, and corrosion of dispensing needles. If the manifold can be taken apart, the inside should be inspected and cleaned.

*After preventive maintenance or whenever taken apart, pipettes and dispensers should be re-calibrated.*

# Washing procedures

1. Washing solutions
2. Manual washing
3. Automatic washing
4. Typical problems
5. Calibration of washers
6. Maintenance of washers



## 1. Washing solutions

The most commonly used washing solution is PBS to which various amounts of NaCl are added to adjust the ionic strength and various amounts of detergent are added to adjust the washing efficiency.

The ionic strength is important in the breaking of non-specific bonds, i.e. the higher ion strength, the better breaking of possible non-specific bonds. However, it should be noted that too high an ionic strength may cause deterioration of molecules, or even breaking of specific bonds.

The detergent is important to the washing efficiency, i.e. removal of loosely bound molecules. The detergent concentration should preferably be in the order of 0.02% to 0.1%. It should be noted that too high a concentration of detergent may cause extensive foam problems. However, the detergent concentration is not so important as the type of detergent used. Tween 20 surfactant is considered a mild detergent, Triton X-100 surfactant a strong detergent, and SDS (sodium dodecyl sulphate) a very strong detergent which should not be used in immunoassays without special considerations as it may detach molecules bound to the solid phase by adsorption.

## 2. Manual washing

The most simple manual washing is pipetting the washing solution into the wells and emptying the plate by flipping out the washing solution over the sink. However, this is very cumbersome when more than a few plates are to be washed.

Manual washing can be facilitated by using 8 or 12 channel washers which can be connected to a vacuum source for aspiration. This type of washers has two needles, one for dispensing by gravity (the short one) and one for aspiration (the long one). The needles may be separate or the shorter may be inside the longer one. To fill the plate the aspiration needles are held just below the top of the wells to aspirate possible excess of washing solution dispensed. To empty the wells the aspiration needles are lowered to the bottom of the wells until the wells are empty. Washing with this type of washers may be fatiguing with a large number of plates, but it is efficient and relatively fast when carried out by a skilled person.

Thermo Scientific Nunc Immuno Washers are available with 8 and 12 channels for 96 well plates or strips, and a new 16 channel version for 384 well plates.

The present Immuno™ Washer has an apparent single channel which contains both delivery and suction sections, facilitating an efficient washing action.

## 3. Automatic washing

Automatic washers exist in a number of different versions. Some wash 8 wells (one column) and some 12 wells (one row), but most automatic washers wash the entire plate (96 wells) simultaneously. All automatic washers require connection to a vacuum source for aspiration. The washing solution may be dispensed by gravity or pump. Some washers use a combination of pump and gravity, i.e. the pump is filling a reservoir (often time adjustable), which is emptied by gravity. These types of washers may have from one to three needles. Those with one needle both dispense and aspirate through this. Those with two needles dispense through the short needle and aspirate through the long needle, whereas those with three needles use a short needle, which has continuous aspiration, for removal of possible excess of washing solution during dispensing, which is done through the middle sized needle.

Very few automatic washers have forced dispensing, i.e. have a pump for each channel.

Washers, which dispense by gravity, are very sensitive to blocking of the dispensing needles by formation of crystals from the salts in the washing solution.

Other types of automatic washers make a tight closure on the top of the wells and flush the wells with washing solution, i.e. dispense and aspirate at the same time.

## 4. Typical problems

Washing is a very crucial step in solid phase immunoassays and several aspects besides the composition of the washing solution should be considered to optimize the washing procedure. It is very important that the washing of each well is identical.



Washing problems can be very difficult to identify as they may give rise to randomly high and low readings or overall increased assay variation without any significant pattern.

Identification of washing problems can be cumbersome and time consuming, especially if the problem occurs at random. Often an easy and fast solution is to re-calibrate the washer.

- a) Dispensing volume and pressure are important as variation in both parameters may have an influence on the washing efficiency. The variation in dispensing pressure may introduce unexpected signal variations.
- b) The vacuum used for aspiration is important and should be adjusted to a proper level. If the vacuum is too high, it may cause severe variation from well to well. If the vacuum is too low, some wells may not be properly emptied, i.e. it may lead to insufficient washing (too high signal) in some wells. It may affect the same wells from plate to plate, but is often random.
- c) The aspiration time is important as too short a time will not empty the wells properly. The aspiration time should be sufficiently long to allow the liquid film on the wall to drain to the bottom of the wells. Too long an aspiration time may partly dry out the coating, which is particularly problematical with an enzyme coating which then may suffer a loss of activity.
- d) Adjustment of aspiration needles is another important parameter in the washing procedure. The washer should be adjusted in such a way that the aspiration needles have identical distance to the bottom of the wells (0.3-0.5mm is considered a proper distance). It is important that the needles do not touch the bottom as that will partly block the flow of the liquid.

For washing of flat bottomed wells it is recommended that aspiration needles are positioned close to the wall of the wells to facilitate emptying.

In flat bottomed wells the very last liquid is drawn to the edge of the wells and may not be completely removed with the needles positioned at the centre of the wells.

For washing of round bottomed wells the aspiration needles should be positioned at the centre of the wells as the liquid will gather at the lowest point of the wells.
- e) Partly blocked aspiration or dispensing needles may result in insufficient washing of the wells. These wells will typically be located in the same positions in all plates.

## 5. Calibrations of washers

Calibration of washers is not a true calibration, but merely a thorough adjustment of different parameters and functions. Many different washers of various designs are available. Therefore it is difficult to give a precise procedure to follow. However, some general, important parameters, which must be adjusted for all instruments can be listed:

- a) Dispensing volume  
Adjust as closely to maximum well volume as possible. Check that all the wells are evenly filled. Clean the dispensing needles, if necessary.
- b) Vacuum  
Most washers work well at a vacuum of 60-70%. A higher vacuum may introduce assay variation. Lower vacuum may not be sufficient to empty all the wells. In either case, the vacuum and aspiration time must be adjusted.
- c) Aspiration time  
Adjust the aspiration time so that it is sufficiently long to allow the film of liquid on the wall to drain to the bottom. Be aware that a too long aspiration time may dry out the coating. Check that all the wells are properly emptied. Clean aspiration needles, if necessary.
- d) Vertical adjustment of aspiration needles  
Adjust the needles to aspirate at the same level, about 0.3 to 0.5mm above the well bottom. Make sure that no needle is touching the bottom.
- e) Horizontal adjustment of aspiration needles  
For flat bottomed wells (F-wells and C-wells) adjust the needles to aspirate close to the wall of the wells. For round bottomed wells (U-wells) adjust needles to aspirate at the centre of the wells.

## 6. Maintenance of washers

### Daily maintenance

Daily maintenance should include checking of dispensing volume, filling uniformity, aspiration efficiency, and cleaning of dispensing and aspiration needles when necessary to obtain correct operation of the washer.

After use, the washer should be thoroughly cleaned with distilled water to remove traces of salt in tubing needles, etc. If possible, drying of the system is recommended. For short periods of time the washer may be left with distilled water and the needles soaked in distilled water.

### Preventive maintenance

At regular intervals, depending on the use, or after long periods without use, the washer should be stripped down as far as possible for cleaning and inspection for possible corrosion. All tubing and connectors should be inspected for possible leakage and integrity.

Mechanical parts should be cleaned and re-greased (if applicable), and any worn parts should be replaced. Whenever something has been taken apart or replaced, the washer should be re-adjusted, as described above.



# Readers

1. OD Readers
2. Typical problems
3. Calibration of readers
4. Maintenance of readers



## 1. OD readers

A wide range of brands and types of readers for MicroWell plates are available. Most readers measure 8 (one column) or 96 wells (one plate) simultaneously, but there are also single well readers. The majority of the readers are automatic, but a few manual readers exist (mainly single well).

Many of the readers have an optical system based on optical fibres, i.e. one fibre per channel and usually a separate fibre for reference.

For most readers you may choose between single or dual beam operation. Dual beam operation is used for correction of optical defects and well to well variation in the plates, i.e. mainly in connection with round bottomed plates.

Wavelength selection may be by filters (one for each wavelength) or by optical grids. Some readers can even make a wavelength scan for each well.

The readers read through the well, i.e. the optical sensors are placed above the plate and the "light source" below, or vice versa. The optical sensors are usually well shielded from false light from the surroundings.

Most readers have a light beam of 1-3mm.

## 2. Typical problems

If the lamp is burnt out, you may get completely nonsense readings, or the reader may not operate at all. Therefore, whenever there is a reading problem, check first that the lamp is lighting.

Unexpected well to well and row to row variation may be caused by dirty sensors or lenses on the light source. Special care should be taken not to overfill the wells as this may deposit droplets on the adjacent part of the optical system. A problem of this kind is not discovered by chance as the optical system is shielded to avoid errors from false light from the surroundings. Row to row variation can also be due to improper calibration of one or more channels or to blanking problems. To check whether the blanking is correct, you should blank the readers on air and read the sample blank, which in principle should give identical OD. Variation in sample blanks will give variation in the samples as the OD of the sample blanks is automatically subtracted from the sample OD, channel by channel.

An easy check for improper calibration is to turn the plate 180° and read the plate again. If the "OD pattern" follows the sensor pattern, the problem is improper calibration. If the "OD pattern" is also reversed, the problem is due to the assay.

Unexpected variation in OD values may be due to instability of the lamp. Read the plate again to see that the value of each individual well can be reproduced. If the OD values cannot be reproduced, but the mean of the plate is practically unchanged, the problem is due to the lamp. If the mean value of the plate has increased, the problem may be due to incomplete denaturation of the enzyme, i.e. bad mixing of substrate and stop reagent.

Gradual rise or fall of OD from column to column over the plate may be due to improper calibration of the step motor advancing the plate row by row. The light beam may be centred in the first column, but gradually it will move to one side or the other, dependent on whether the column to column "step" is too short or too long, i.e. at a certain column, part of the light beam may hit the wall of the well. If the light beam is not well centred, the meniscus of the liquid may also give rise to OD variation, dependent on the diameter of the light beam.

OD readings, which are obviously too low in comparison to a visual judgement, are often due to reading at a wrong wavelength. Check that the individual filters have assigned the correct values, and that the correct filter or wavelength has been selected. A similar result is seen by dual beam readings if the difference in wavelength is too small. The wavelength difference should always be the largest possible.

## 3. Calibration of readers

Calibration of multi-channel readers requires a special calibration filter, which may be obtained from the manufacturer of the reader or from companies specialized in calibration of optical instruments. Calibration filters are often called grey filters, which are mounted in a plate of the same size as a MicroWell plate. Grey filters can be used for calibration at any wavelength. A calibration filter should preferably have filters for three different OD levels, i.e. low, medium and high, and the correct OD value for 2-3 different wavelengths should be indicated.



If any channel to channel variation is observed at the calibration, then turn the calibration filter 180° and read again to check that the difference is not due to the filter itself.

If the reader is out of calibration, it may be corrected by adjusting each individual sensor. However, calibration adjustment of readers may be so complicated that it requires a specialist. Adjustment of the linearity can be especially complicated.

It should be noted that multi-channel readers do not necessarily show the exact (absolute) OD value, however, for practical use small deviations can be accepted, as it is often more important that each channel shows identical reading than a correct, absolute value.

If you do not have access to a calibration filter, you may check the calibration by dispensing equal amount of a colored solution into a MicroWell plate and read the plate normally and turned through 180°. If both readings give identical mean values for all rows, the reader is in calibration.

Usually, a wavelength calibration requires a specialist, but if the calibration with a calibration filter is giving correct values at two or more wavelengths, it can usually be assumed that a wavelength calibration is not needed.

To check if the calibration of the column to column step size is correct, you may read an empty plate. If no column to column mean differences are observed from the first to the last column, you may assume the step size is correct. Adjustment of the step size may be described in the manual of the reader; if not, a specialist is required.

## 4. Maintenance of readers

### Daily maintenance

Daily maintenance should comprise inspection of sensors and light source for each channel, which should be cleaned, if necessary. To check that the calibration is OK, allow the reader to warm up for a minimum of 30 minutes, then blank on air, and then read a module filled with substrate, i.e. one well per channel. In principle the reading should be identical. If not, reverse the module, and read again to see whether the variation is due to the reader or to the “module”. If the reader has automatic plate advance, you should check that the plate advances smoothly.

### Preventive maintenance

At regular intervals the reader should be calibrated and the stability of lamp checked by reading the same plate (calibration filter) at an interval of 15–30 minutes. The optical filters should be inspected and cleaned, if necessary. The plate carrier and plate advance system should be cleaned. If the plate carrier is of a type with a “read through hole” for each well, you should check that each well is properly aligned over the holes; adjust, if necessary. Whenever any adjustment has been made, the reader should be re-calibrated.

# Capture, pre- and post-capture reagents

1. Capture reagent
2. Pre-capture reagent
3. Post-capture reagent

## Definition

These reagents relate to the preparation of the solid surface in order to establish a solid phase capable of analyte capture and detection reagent refusal. If these properties are defective, the result will be poor assay sensitivity due to low signals, or high background, or both.

## 1. Capture Reagent

This reagent is, upon adsorption to the solid surface, responsible for the (selective) capture of analyte by the solid phase. In principle, the naked surface itself may serve as the capture reagent. The most common capture reagent molecules to be adsorbed for immuno-sorbent assays are high-molecular weight antibodies or antigens, or low-molecular weight haptens (i.e. antigenic determinants) in aqueous solution.

### Solid surface affinity

The quality (stability) of the capture reagent adsorption to a solid surface is dependent on the types of bonds that can be established between the capture reagent and the surface. The four different bond types to be considered are listed in order of increasing strength: the hydrophobic bond, the hydrogen or hydrophilic bond, the ionic bond, and - the strongest - covalent bond. The hydrophobic and hydrophilic bonds are responsible for physical adsorption, and the ionic and covalent bonds for chemical adsorption. One or more of these bond types may be involved in the adsorption, dependent on the natures of the capture reagent molecule, the solid surface, and the capture reagent buffer.

The hydrophobic, hydrophilic and ionic bonds apply mainly to adsorption of macro-molecules, since numerous bonds of these types would normally be required for a stable adsorption. Accordingly, the strong covalent bond would normally be required for a stable adsorption of small molecules. The hydrophobic bond is established by close contact between hydrophobic (i.e. hydrocarbon) moieties in the molecule and on the solid surface. Since the hydrophobic bond is the weakest type, a stable hydrophobic adsorption demands

that large, mainly hydrophobic, moieties are present in the molecule to match with large hydrophobic areas on the solid surface. In this case, an entirely hydrophobic surface, like the PolySorp surface, should be chosen. Molecules that contain hydrophilic groups, in particular  $-OH$ ,  $=O$ ,  $-NH_2$ ,  $=NH$ , and  $ZN$ , can be adsorbed by hydrophilic bonds, provided that matching hydrophilic groups are present on the solid surface.

Molecules containing ionic charges can be adsorbed by ionic bonds if reciprocal ionic charges are present on the surface. Due to the polarized nature of hydrophilic groups, hybrid hydrophilic and ionic bonds may also be established. Since hydrophilic and ionic groups are often scattered among hydrophobic moieties in macro-molecules, a stable adsorption may not be obtained by hydrophilic and ionic bonds alone, prone, as they are, to dissociation by water molecule interference. In this case, a partly hydrophilic surface like the MaxiSorp or Thermo Scientific Nunc MediSorp surface should be chosen, to match the hydrophobic/hydrophilic patchwork of the molecule. Immobilization by covalent bonds can be established if the molecule and the surface contain appropriately interactive groups (e.g.  $-SH$  groups to form  $-S-S-$  bridges) or are appropriately activated prior to adsorption. Suitable for covalent adsorption may be the CovaLink NH surface capable of coupling molecules by, for example, their carboxylic groups (cf. hapten capture reagent).

### Adsorption orientation

Optimal adsorption includes both adsorption stability and orientation of the capture reagent molecule that exposes its analyte capturing site. The capture reagent cannot be adsorbed using the same molecular site since they would thereby be partly or entirely obstructed. When physical adsorption (of large, complex molecules) is concerned, the orientation will usually be more or less accidental, so that not all the adsorbed molecules could be expected to be capable of analyte capture. The molecular orientation may to some extent be controlled by the buffer composition (e.g. pH relative to the capture reagent, determining the

molecular charge), and the choice between available solid surfaces. Since analyte binding sites are usually associated with functional groups, it may often be favorable (with antigens) to aim at hydrophobic adsorption, using a hydrophobic surface.

A more precise orientation control may be obtainable by covalent coupling. In general, if an available surface is not immediately suitable, it may be made so by adsorption of an appropriate pre-capture reagent. When smaller molecules are concerned, their entirety may be involved with physical adsorption, thus obstructing their analyte accessibility. For this reason, covalent binding of a small molecule, possibly directed to a defined chemical group may be preferable. This alternative also affords greater stability of the capture reagent. If the solid surface itself is not capable of covalent coupling, the capture reagent adsorption may be preceded by adsorption of a competent pre-capture reagent, also serving as a spacer to separate the small capture reagent from the surface, facilitating analyte access.

### Adsorption denaturation

Even if the initial adsorption of a macromolecule has occurred favorably on the solid surface, i.e. by keeping the analyte capture site exposed, the site may degenerate because of molecular unfolding due to extension of the adsorptive contact face with time. This may be avoided by adsorption of the capture reagent in the closest possible packing (surface saturation), or by simultaneous or subsequent adsorption of a sterically supporting post-capture reagent, or both.

### Adsorption density

In principle, the more capture reagent molecules that are adsorbed, the more analyte molecules can be captured. That is, the optimum capture reagent adsorption density may correspond to solid surface saturation. The upper limit to the saturating number of molecules is determined geometrically by the densest possible packing on the surface, dependent on the size (molecular weight) and shape of the molecule. Fig. 25 presents an average relationship between the capture reagent molecular weight and saturating mass density, from which the saturating capture reagent concentration can be roughly estimated. To achieve surface saturation within a

reasonable incubation time, one should use a capture reagent concentration considerably larger (e.g. 3x) than this estimate. However, at dense packing of the capture reagent molecules, one may risk that their analyte capture capability is impeded by mutual steric hindrance. Therefore, one should always, in principle, make concentration trials to determine the capture reagent density optimal for analyte capture. If a sub-saturating density turns out to be optimal, an appropriate post-capture reagent should be adsorbed to support the capture reagent conformational integrity, either following the capture reagent adsorption, or together with the capture reagent in a competitive balance determining the optimal capture reagent density. In this connection, the capture reagent purity should also be considered, since impurities could possibly compete with the capture reagent for adsorption, thus influencing the capture reagent density.

### Solubility

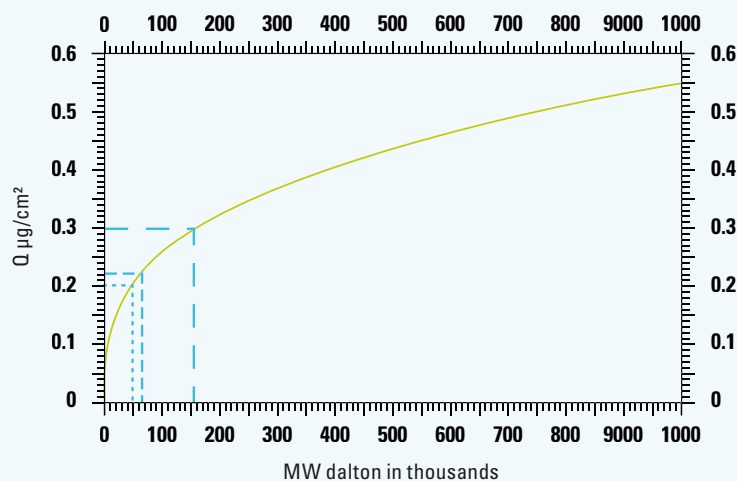
If the capture reagent is not sufficiently water soluble, a competent solvent should be employed to solubilize the capture reagent for adsorption. Either the solvent is added to the aqueous buffer solution (in case of water-miscible solvents like detergent and alcohol), or the solvent replaces water entirely (e.g. in case of water-immiscible solvents like hexane). Solvents and detergents may interfere severely with the capture reagent adsorption. This is especially relevant in the case of detergents which may reciprocally coat hydrophobic and hydrophilic areas of the capture reagent and the solid surface with hydrophilic and hydrophobic films, preventing the capture reagent from being physically adsorbed. Thus, 0.05% detergent is commonly known and used as an effective inhibitor of unspecific physical adsorption during the later immuno-specific solid phase couplings.

### Analyte specific affinity

It is important that the capture reagent has a high and selective affinity for the analyte, since any other affinity, especially for detection reagents, would impair the assay sensitivity and reliability. This relates to the quality of the capture reagent preparation, which should yield capture reagent molecules with the highest possible analyte affinity and selectivity, of

Fig. 25

Average relationship between surface saturating mass density ( $Q$ ) and molecular weight (MW) of globular molecules based on the conditions for an idealised IgG molecule with a Stokes radius = 5nm, and MW = 153,000D (—). The other interpolations correspond to (strept)avidin or BSA (- - -) and protein A (- · - ·).





the highest possible homogeneity and purity. Low-affinity or non-homogeneous preparations (small specific fraction), especially of antibodies, will cause poor analyte capture, and subsequently low assay signals, whereas improper purification, especially of antigens, is a frequent cause of high background.

### Antibody capture reagent

Antibodies are glycoproteins with a structure illustrated schematically in Fig. 26. Since their hydrophilic carbohydrate moieties are associated with the Fc leg of the molecule, opposite the antigen-recognising Fab legs, the proper orientation would be favored by adsorption to a solid surface, capable of hydrophilic adsorption, e.g. the MaxiSorp surface, which is optimized particularly for antibody adsorption with a saturating IgG density of approximately 0.65mg/cm<sup>2</sup>.

The capture reagent antibody should be from the same species as the primary detection reagent antibody, if this is used alone, to minimize the risk of antibody cross-reaction. However, if a secondary detection antibody is also used, the capture reagent antibody must be from a species other than the primary one to avoid cross-reaction with the secondary one.

The analyte capturing capability of adsorbed antibodies is dependent on the particular antibody preparation. The IgG fraction of immunologically raised polyclonal anti-sera will comprise antibodies with target (analyte) affinities ranging from high affinity through medium and low (no) affinity, the latter being unable to bind analyte, thus reducing the analyte capture capability of the preparation by competing with the others for adsorption. In this case, surface saturation with antibodies would probably be optimal. An affinity-isolated IgG preparation will contain antibodies with more uniform, but mainly medium-range affinities, which are more sensitive to steric hindrance. In this case, a sub-saturation antibody density would probably be optimal, which should be estimated by trials with various densities and a low analyte concentration for the highest assay signal. A monoclonal antibody preparation comprises antibodies with identical, monospecific affinity and structure details. If an antigen analyte only possesses few different determinants, a monoclonal antibody capture reagent, specific for one determinant, may be used in combination with a monoclonal antibody detection reagent,

specific for another determinant, to avoid sensitivity decreasing competition. However, since monoclonal antibodies are selected by analyte affinity only, and not by solid surface affinity, they often adsorb poorly to a solid surface, depending on structure details, and should therefore be used as capture reagent only when necessary.

The adsorption and orientation of antibodies may be improved by adsorption of certain pre-capture reagents prior to antibody adsorption.

### Antigen capture reagent

Antigens are molecules that can evoke an immunological response: this includes a wide variety of macro-molecules, which often contain multiple, different determinants (epitopes). Physical adsorption would normally be adequate for antigens, but it may be difficult to decide which available solid surface a priori would be optimal for adsorption of a particular antigen, since the surface affinity may count in favor of one surface type, and the analyte affinity in favor of another surface type.

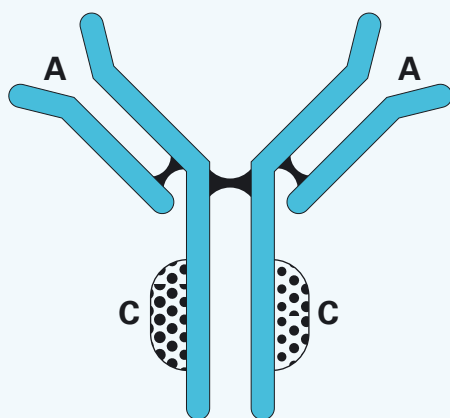
It is therefore recommended that trials are made to determine the optimal solid surface, e.g. MaxiSorp or PolySorp. The latter is often found to be the best choice for antigen adsorption, probably because it favors the exposure of determinants, which usually contain functional (hydrophilic) groups.

### Hapten capture reagent

As haptens are of low-molecular weight they cannot themselves evoke an immunological response, unless they are linked to a macro-molecular “carrier” which can elicit a response. However, once established, the relevant antibody is able to bind specifically to the particular hapten. Thus, instead of whole antigen adsorption for assaying an antibody analyte, it might be favorable to adsorb a significant hapten in order to get a maximum specificity.

Haptens are often particular peptide sequences or carbohydrates, which are too small, per se, to be physically adsorbed in a sufficiently stable and accessible way. One way to overcome this difficulty is to conjugate multiple copies of the required hapten to a neutral carrier macro-molecule (e.g. a hormone hapten to BSA), which can then be physically adsorbed. Covalent conjugation may be established via bifunctional linkers, such as glutaraldehyde for conjugation of amino-containing molecules, or commercially available linkers with other coupling capabilities. Alternatively, a different hapten, or biotin, may be bound to the hapten for coupling to physically adsorbed, specific receptor pre-capture reagents (i.e. specific antibodies or avidin, respectively). A third possibility would be to use a solid surface bearing functional groups (preferably positioned at the end of appropriately long spacer arms), capable of direct covalent coupling of the hapten (upon appropriate activation). For such applications, CovaLink and Immobilizer surfaces contain covalently grafted spacer arms ending in specific groups, capable of establishing bonds to various reactive sites.

Fig. 26



Schematic illustration of an IgG antibody bearing the antigen-recognising sites (A) on the Fab legs in positions opposite to the carbohydrate moieties (C) on the non-recognising Fc leg.

## 2. Pre-capture Reagent

This reagent is applied as a connecting link between the solid surface and the capture reagent if this cannot immediately be immobilized adequately on available surfaces. In fact, the aim of using a pre-capture reagent is nothing more than to establish a new solid surface, which is better suited for capture reagent adsorption than the naked surface. In principle, the pre-capture reagent adsorption itself may involve a sequence of molecular layers.

Thus, since the pre-capture reagent acts as a reagent for capture of the analyte capture reagent, the general description in the capture reagent section about solid surface affinity, adsorption orientation, adsorption denaturation, adsorption density, solubility, and analyte specific affinity also applies to the pre-capture reagent by reading pre-capture reagent instead of capture reagent, and capture reagent instead of analyte.

### Antibody pre-capture reagent

If an analyte capturing antigen is poorly adsorbed to the naked solid surface, an antibody pre-capture reagent adsorption may be used to capture the antigen. What has been said about antibody capture reagent adsorption in the capture reagent section is also valid here, except that the pre-capture reagent antibody must always be from another species than the analyte antibody to avoid cross-reaction with the detection reagent antibody.

### Protein A pre-capture reagent

Protein A (from *Staphylococcus aureus*) is a tetrameric compound (MW approx. 50,000 D) capable of binding specifically with the non-recognising Fc leg of antibodies (cf. antibody capture reagent in the capture reagent section). Therefore, employment of protein A pre-capture reagent adsorption, feasible on e.g. MaxiSorp surfaces, may improve the proper orientation and conformational integrity of capture reagent antibodies. Especially for adsorption of a “difficult” monoclonal antibody capture reagent, the protein A approach might seem favorable. However, since protein A's antibody affinity varies between antibody sub-types, the difficulty of monoclonal antibody adsorption on the solid surface may merely be substituted by a similar difficulty with the protein A mediated adsorption.

Since protein A binds polyclonal antibodies indiscriminately, it may be difficult to avoid cross-reaction with detection reagent antibodies, and an alternative detection system may therefore be applied, possibly an assay with sample analyte in competition with labeled standard analyte.

## 3. Post-capture Reagent

This reagent is used to block detection reagent access to the solid phase (i.e. solid surface and pre-capture reagent) and for stabilization of the capture reagent by steric support.

Thus, the post-capture reagent should have the highest possible affinity for the solid surface and for the pre-capture reagent and the highest possible indifference in all other respects. What is said about solid surface affinity, and solubility, in the capture reagent section also holds for the post-capture reagent. In principle, more than one post-capture reagent may be used, e.g. one after pre-capture reagent adsorption (to block excess solid surface), and another after capture reagent adsorption by the pre-capture reagent (to block excess pre-capture reagent binding sites).

### Adsorption density

To secure a fast and effective blocking of excess solid phase binding sites, the post-capture reagent should be used in a large excess compared to the estimated number of binding sites. If the post-capture reagent is adsorbed together with the capture (or pre-capture) reagent to obtain a certain density of the latter, the concentration of the balanced mixture should also exceed the number of binding sites (cf. adsorption density in the capture reagent section).

### Molecular size

For blocking excess solid surface by physical adsorption, the post-capture reagent should be large enough for a stable physical adsorption and for proper steric support of pre-capture reagent, yet small enough to be an effective surface space-filling, and not to interfere with the specific binding capabilities of the pre-capture reagent by steric hindrance.

For blocking excess pre-capture reagent binding sites neutral capture reagent analogues may be conveniently used, since molecular size is less critical in this case. For example, neutral antibodies may be used for blocking excess protein A binding sites after adsorption of capture reagent antibodies (cf. protein A post-capture reagent in the pre-capture reagent section). Likewise, for blocking excess functional (covalent) binding sites, neutral pre-capture analogues may be used, e.g. neutral hapten analogues after hapten binding on the Covalink NH surface (cf. hapten capture reagent in the capture reagent section).

### Protein A post-capture reagent

The most commonly used post-capture reagent for physical blocking of excess solid surface after adsorption of macromolecular (pre-)capture reagents is bovine serum albumin (BSA), e.g. 0.5% BSA in PBS applied for 15 minutes. The size (MW 70,000 D) and adsorption properties of BSA makes it well suited for blocking and steric support in combination with antibody pre-capture reagent adsorption on MaxiSorp surfaces. Even more effective as blocking agents may be whole bovine serum, skimmed milk (reconstituted powder) or casein, due to their multi-sized molecular content. Serum lipoproteins (high density lipoproteins, HDL) may be more stable as blocking agents for the hydrophobic PolySorp surface, although their MW 200,000 D may be sub-optimal with respect to surface space filling and steric hindrance of pre-



capture reagents. In some cases, however, due to their common environmental appearance, these agents may be recognized by some other assay reagents, and it may be necessary to use more "distant" agents such as fish skin gelatin.

### **Detergent post-capture reagent**

In principle, the most versatile agents for solid surface blocking by physical adsorption are detergents, because they are equally capable of hydrophobic and hydrophilic adsorption, thus preventing other molecules from being hydrophobically or mixed hydrophobically/hydrophilically adsorbed (cf. solid surface affinity and solubility in the capture reagent section). However, due to their small size, adsorbed and desorbed detergent molecules would normally be in an equilibrium of rapid exchange and would therefore desorb rapidly upon their removal from the liquid phase. Nevertheless, the relatively high molecular weight detergent, Tween 20, may exert a stable blocking (of MaxiSorp surfaces at least), once applied.

The simultaneous use of detergent with another agent for physical blocking should be used with caution as it may prevent the other agent from being adsorbed.

# Hybridization detection of PCR products

## Covalent binding of solid phase capture oligonucleotide

1. The solid phase capture oligonucleotide must be phosphorylated or aminated at the 5'-end, and a linker of at least 10 T's (Thymidine) should be added to the 5'-end of the oligonucleotide.
2. Use a freshly made coating mix consisting of: 100nm solid phase capture oligonucleotide and 10mm EDC (1-ethyl-3-(3-dimethylaminopropyl)-carbodiimide) in 10mm 1-methylimidazole (1-MeIm) (pH 7.0).
3. Add 100µL of this coating mix to each NucleoLink well. This gives a total of 10pmol added to each well of the 5'-phosphorylated or aminated solid phase oligonucleotide.
4. Seal the NucleoLink strips (e.g. with Thermo Scientific Nunc Sealing Tape).
5. Incubate the NucleoLink strips at 50°C for 4-24 hours.
6. To remove coating solution residues, wash the emptied NucleoLink wells three times, soak for five minutes and wash three times, all with 100mm TRIS-HCl (pH 7.5), 150mm NaCl, and 0.1% Tween 20 surfactant at room temperature (RT). Empty the strips.
7. To remove salt residues, wash the emptied NucleoLink wells three times, soak for five minutes and wash three times, all with deionized sterile water.
8. The emptied, coated NucleoLink strips can be stored at 4°C or below in an polyethylene bag. The strips should not be sealed.

## Amplification

1. The amplification should be made as usual in traditional PCR tubes.

2. In order to label the PCR product, the amplification should be made using either:
  - a) Biotinylated primers (one or both PCR primers can be labeled), or
  - b) Addition of DIG-11-dUTP (a digoxigenin labeled oligonucleotide) (Digoxigenin-11-2'-deoxyuridine-5'-triphosphate, alkali-stable) at a concentration of 4µM. The concentration of dTTP should be lowered to 0.125mM. All other concentrations are unchanged. If non-labeled PCR products are detected, a labeled probe, complementary to the same strand as the solid phase capture probe, should be added during the hybridization. Other labels can also be used, but the above-mentioned labels have all been tested by the Thermo Fisher Scientific research laboratory.

## Detection

1. Add 10µL of the PCR product to the NucleoLink wells with the solid phase capture probe covalently bound.
2. Add 10µL of 1M NaOH with 0.5mg/µL thymolblue. This liquid is dark blue.
3. Incubate for 10 minutes at RT.
4. To each well, add 80µL of 6.25 x SSC, 0.625% blocking reagent (BR), 0.125% Tween 20 surfactant and 0.5M NaH<sub>2</sub>PO<sub>4</sub> adjusted to pH = 6.5 with NaOH. The pH of this mixture is 7.5, and the liquid should become yellow. If the color is red (acidic) or blue (alkaline), the hybridization will not be successful.
5. Incubate for 30 minutes to two hours at 50°C (each system should be optimized individually).
6. Wash the NucleoLink wells three times at RT with 0.5 x SSC and 0.1% Tween 20 surfactant.





7. Soak for 15 minutes at 50°C with 0.5 x SSC and 0.1% Tween 20 surfactant.
8. Wash three times at RT with 0.5 x SSC and 0.1% Tween 20 surfactant.
9. Detection of biotin-labeled PCR product:
  - a) When using Alkaline phosphatase (AP):  
Add to each well 100µL AP conjugated streptavidin diluted 1:3000 (or as the producer suggests) in 100mm TRIS-HCl (pH 7.5), 150mm NaCl, 0.1% Tween 20 surfactant, and 0.5% BR.
  - b) When using Horse Radish Peroxidase (HRP):  
Add to each well 100µL HRP conjugated streptavidin diluted 1:5000 (or as the producer suggests) in 100mm TRIS-HCl (pH 7.5), 150mm NaCl, 0.1% Tween 20 surfactant, and 0.5% BR.
10. Detection of digoxigenine labeled PCR product:  
Add to each well 100µL anti-dig conjugated Antidigoxigenin-AP diluted 1:5000 in 100mm TRIS-HCl (pH 7.5), 150mm NaCl, 0.1% Tween 20 surfactant, and 0.5% BR.
11. Incubate for one hour at 37°-50°C sealed with Sealing Tape.
12. Wash the emptied NucleoLink wells three times, soak for five minutes and wash three times with 100mm TRIS-HCl (pH 7.5), 150mm NaCl, and 0.1% Tween 20 surfactant at RT.
13. Two substrates have been tested with AP; 4-MUP (4-methylumbelliferyl phosphate) and pNPP (para nitrophenylene phosphate). One color forming reagent has been tested with HRP; TMB (3,3',5,5'-tetramethylbenzidine) in a ready-to-use solution.
  - a) When using 4-MUP:  
Add 100µL of 1mm 4-MUP dissolved in 1M diethanolamine (pH 9.8) and 1mm MgCl<sub>2</sub> to each well.
  - b) When using pNPP:  
Add 100µL of 1 or 10mg/mL pNPP in 1M diethanolamine (pH 9.8) and 1mm MgCl<sub>2</sub> to each well.
  - c) When using TMB:  
Add 100µL of the ready-to use solution to each well.

#### 14. Substrate incubation

The NucleoLink Strips should be sealed with Sealing Tape when incubating for longer than 30 minutes.

- a) When using 4-MUP, incubate at 37-50°C in the dark for 30-60 minutes. To stop the hydrolysis of 4-MUP, add 50µL of 3M K<sub>2</sub>HPO<sub>4</sub>.

- b) When using pNPP, incubate at RT for 30 minutes (10mg/mL) to 24 hours (1mg/mL). Add 100µL of 1M NaOH to stop hydrolysis of pNPP.

- c) When using TMB, incubate for 30 minutes at RT. Add 100µL 0.1M H<sub>2</sub>SO<sub>4</sub> to stop the reaction. Note: Rehybridization is not possible after addition of acid.

#### 15. To measure the signal

- a) For detection of hydrolyzed 4-MUP, determine the signal in fluorescence plate reader: Excitation wavelength 360nm, emission wavelength 450nm (also if the reaction has been stopped with K<sub>2</sub>HPO<sub>4</sub>).
- b) For detection of hydrolyzed pNPP, measure OD in a normal ELISA plate reader at 405nm (also if the reaction has been stopped with NaOH). For detection of TMB, measure OD in a normal ELISA plate reader at 450nm after the reaction has been stopped with acid (if the reaction is not stopped with acid, the color is blue and can be measured at 655nm).

# Common reagent recipes

## Recommended buffers and solutions



### Acetate buffer, pH 4.0

pH: 4.0

Molarity: 0.2 M

#### Reagents

Acetic acid (99.8%)  
NaOH

#### Method

Acetic acid (99.8%) 11.5mL  
NaOH 1.4g

Milli-Q-H<sub>2</sub>O to 1000mL  
Adjust pH to 4.0

### 10 x citrate-phosphate buffer

pH: 5.0

Molarity: 1.0M

#### Reagents

C<sub>6</sub>H<sub>8</sub>O<sub>7</sub> · 1H<sub>2</sub>O  
Na<sub>2</sub>HPO<sub>4</sub> · 2H<sub>2</sub>O

#### Method

C<sub>6</sub>H<sub>8</sub>O<sub>7</sub> · 1H<sub>2</sub>O 73.0g  
Na<sub>2</sub>HPO<sub>4</sub> · 2H<sub>2</sub>O 118.6g

Distilled H<sub>2</sub>O to 1000mL  
Adjust pH to 5.0 using a concentrated NaOH solution

### Carbonate buffer

pH: 9.6

Molarity: 0.05M

#### Reagents

Na<sub>2</sub>CO<sub>3</sub>  
NaHCO<sub>3</sub>

#### Method

Na<sub>2</sub>CO<sub>3</sub> 1.59g  
NaHCO<sub>3</sub> 2.93g

Distilled H<sub>2</sub>O to 1000mL  
Adjust to pH 9.6, if necessary

### 10 x carbonate buffer

pH: 9.6

Molarity: 0.5M

#### Reagents

Na<sub>2</sub>CO<sub>3</sub>  
NaHCO<sub>3</sub>

#### Method

Na<sub>2</sub>CO<sub>3</sub> 15.9g  
NaHCO<sub>3</sub> 29.3g

Milli-Q-H<sub>2</sub>O to 1000mL  
Check pH and, if necessary, adjust to 9.6



## PBS

pH: 7.2

Molarity: 0.15M

### Reagents

10 x PBS

### Method

10 x PBS

100mL

Milli-Q-H<sub>2</sub>O to 1000mL

Adjust pH to 7.2 using 1N NaOH

## 10 x PBS

pH: 7.2

Molarity: 1.5M

### Reagents

NaCl

KCl

Na<sub>2</sub>HPO<sub>4</sub> · 2H<sub>2</sub>O

KH<sub>2</sub>PO<sub>4</sub>

### Method

NaCl

400.0g

KCl

10.0g

Na<sub>2</sub>HPO<sub>4</sub> · 2H<sub>2</sub>O

57.5g

KH<sub>2</sub>PO<sub>4</sub>

10.0g

Milli-Q-H<sub>2</sub>O to 5000mL

Adjust pH to 7.2

## Cova-buffer

### Reagents

NaCl

MgSO<sub>4</sub> · 7H<sub>2</sub>O

Tween 20 surfactant

10 x PBS

### Method

NaCl

116.88g

MgSO<sub>4</sub> · 7H<sub>2</sub>O

10.0g

10 x PBS

100mL

Tween 20 surfactant

0.5mL

Milli-Q-H<sub>2</sub>O to 1000mL

## OPD/H<sub>2</sub>O<sub>2</sub>

### Reagents

OPD-tablets 30mg/tablet

30% H<sub>2</sub>O<sub>2</sub>

10 x Citrate-Phosphate Buffer

### Method

10 x Citrate-Phosphate buffer

10mL

Deionised H<sub>2</sub>O to 100mL

OPD tablets

2 x 30mg

30% H<sub>2</sub>O<sub>2</sub>

50μL

### Comments

Prepare fresh each day

## Washing solution

### Reagents

10 x washing solution

Triton X-100 surfactant

### Method

10 x washing solution

1000mL

Triton X-100 surfactant

5mL

Deionised water to 10 litre

### Comments

Triton X-100 surfactant is added to 10 x washing solution while stirring, then the deionised water is added.

## 10 x washing solution

### Reagents

NaCl

KCl

KH<sub>2</sub>PO<sub>4</sub>

Na<sub>2</sub>HPO<sub>4</sub> · 2H<sub>2</sub>O

### Method

NaCl

1010g

KCl

10g

KH<sub>2</sub>PO<sub>4</sub>

10g

Na<sub>2</sub>HPO<sub>4</sub> · 2H<sub>2</sub>O

57.5g

Milli-Q-H<sub>2</sub>O to 5000mL

## 2N H<sub>2</sub>SO<sub>4</sub>

### Reagents

H<sub>2</sub>SO<sub>4</sub> (conc.)

### Method

H<sub>2</sub>SO<sub>4</sub> 56mL

Deionised water to 1000mL

### Remember

Acid to water.

## PBS detergent

pH: 7.2

Molarity: 0.15M

### Reagents

10 x PBS

Tween 20 surfactant

### Method

10 x PBS 100mL

Milli-Q-H<sub>2</sub>O to 1000mL

Adjust pH to 7.2 before adding Tween 20 surfactant, mix well

Tween 20 surfactant 0.5mL

### Comments

The solution can also be prepared simply by adding Tween 20 surfactant to PBS.

## 10 x PCR-buffer

pH: 8.3

### Reagents

1M TRIS-HCl \*

2.5M KCl \*

Tween 20 surfactant

*\*1M TRIS-HCl and 2.5M KCl should be prepared the same day as the PCR buffer*

Method	Volume (µL)	Final conc.
TRIS-HCl 1M	5000	100mm
KCl 2.5M	10000	500mm
Tween 20 surfactant	500	1%

Adjust pH to pH 8.3, if necessary

Distilled H<sub>2</sub>O to 50mL

### Comments

Filter sterilize.

Store at -20°C in 1mL aliquots in Thermo Scientific Nunc CryoTube vials.

## TRIS-HCl

pH: 8.3

Molarity: 1M

### Reagents

TRIS-HCl

TRIS base

### Method

Method	Amount	Final conc.
TRIS-HCl	6.14g	0.4M
TRIS base	7.40g	0.6M

Adjust pH to 8.3, if necessary

Distilled H<sub>2</sub>O to 100mL

### Comments

Filter sterilize.

Store at room temperature, in 50mL lots, or 1mL aliquots.

If the solution is to be used as PCR buffer, it must be freshly prepared.

## 0.5 x SSC + 0.1% Tween 20 surfactant wash buffer

### Reagents

20 x SSC

Tween 20 surfactant

### Method

Method	Volume	Final conc.
20 x SSC	25mL	0.5 x
Tween 20 surfactant (conc.)	1mL	0.1%

Adjust pH to 7.0

Distilled H<sub>2</sub>O to 1000mL

### Comments

Store at room temperature.

## PBS BSA

pH: 7.0

### Reagents

PBS

Bovine albumin (BSA)

### Method

Method	Amount	Final conc.
PBS	100mL	
BSA	0.50g	0.5%

Pour the PBS into a suitable beaker. Place the BSA on the surface, wait until the crystals sink into the liquid. Stir gently with a magnetic stirrer. Avoid the creation of froth as much as possible.



### 10 x Phosphate Buffer

pH: 8.0

Molarity: 0.1M

#### Reagents

Na<sub>2</sub>HPO<sub>4</sub> · 2 H<sub>2</sub>O  
KH<sub>2</sub>PO<sub>4</sub>

#### Method

Na <sub>2</sub> HPO <sub>4</sub> · 2H <sub>2</sub> O	16.82g
KH <sub>2</sub> PO <sub>4</sub>	0.749g

Dissolve approx. 900mL Milli-Q-H<sub>2</sub>O  
Make to 1000mL in a measuring cylinder

### Phosphate buffer

pH: 8.0

Molarity: 0.01M

#### Reagents

10 x phosphate buffer (pH 8.0)

#### Method

10 x phosphate buffer (pH 8.0)	100mL
Milli-Q-H <sub>2</sub> O	Approx. 850mL

Adjust pH to 8.0 using dilute NaOH or HCl  
Milli-Q-H<sub>2</sub>O to 1000mL

### 20 x SSC wash buffer

pH: 7.0

#### Reagents

NaCl  
Tri-Sodiumcitrate · 2 H<sub>2</sub>O

#### Method

Method	Amount	Final conc.
NaCl	175.3g	3.0M
Tri-Sodiumcitrate · 2 H <sub>2</sub> O	88.2g	0.3M

Dissolve in 800mL Milli-Q water  
Adjust pH to 7.0 using a few drops of 10N HCl  
Make up to 1000mL using Milli-Q water

#### Comments

This solution should be autoclaved, then stored at room temperature.

### 5 x SSC + 0.1% Tween 20 surfactant + 0.5% blocking reagent hybridization buffer

pH: 7.0

#### Reagents

20 x SSC  
Tween 20 surfactant  
Blocking Reagent

#### Method

Method	Amount	Final conc.
20 x SSC	125mL	5 x
Tween 20 surfactant	0.5mL	0.1%
Blocking Reagent	2.5g	0.5%

Check pH and adjust to 7.0, if necessary  
Distilled H<sub>2</sub>O to 500mL

The blocking reagent is dissolved by warming at 50°C for 1-2 hours with regular stirring. Stir O/N at RT.

#### Comments

The incubation buffer should be dispensed in 50mL aliquots and stored at -20°C.  
Do not refreeze. After first thawing store remainder at 4°C.

### TRIS-Incubation buffer

pH: 7.5

#### Reagents

TRIS wash buffer (10 x)  
Blocking Reagent

Method	Amount	Final conc.
10 x TRIS wash buffer	50.0mL	100mm TRIS, 150mm NaCl, 0.1% Tween 20 surfactant

Distilled H <sub>2</sub> O to 500mL		
Blocking Reagent	2.5g	0.5%

Check pH, adjust to pH 7.5, if necessary

Dissolve the Blocking Reagent by placing it at 50°C for 1-2 hours stirring regularly. Stir O/N at RT

#### Comments

The incubation buffer should be dispensed in 50mL aliquots and stored at -20°C.

Do not refreeze. After first thawing store remainder at 4°C.

### 1 x TRIS wash buffer

pH: 7.5

#### Reagents

10 x TRIS wash buffer

#### Method

Final concentration	Amount	Final conc.
10 x TRIS wash buffer	100mL	1 x

Check the pH, adjust to pH 7.5, if necessary

Distilled H<sub>2</sub>O to 1000mL

#### Comments

Can be stored at room temperature.

### 10 x TRIS wash buffer

pH: 7.5

#### Reagents

TRIS-HCl  
TRIS base  
NaCl  
Tween 20 surfactant

Method	Amount	Final conc.
TRIS-HCl	127.00g	0.8M
TRIS base	23.60g	0.2M
NaCl	87.66g	1.5M
Tween 20 surfactant (conc.)	10.0mL	1%

Check pH and adjust to pH 7.5, if necessary

Distilled H<sub>2</sub>O to 1000mL

#### Comments

Store at room temperature.

### 4-MUP substrate

pH: 9.8

Molarity: 1mm

#### Reagents

Diethanolamine  
MgCl<sub>2</sub> · 6H<sub>2</sub>O  
4-methylumbelliferyl phosphate (4-MUP)

Method	Amount	Final conc.
Diethanolamine	95.6mL	1M

Is added to 800mL distilled H<sub>2</sub>O  
Adjust to pH 9.8 using NaOH/HCl

Then add

MgCl <sub>2</sub>	0.2033g	1mm
4-MUP	0.2562g	1mm

Make up to 1000mL with distilled H<sub>2</sub>O

#### Comments

As it is difficult to remove the diethanolamine from the measuring cylinder, it is necessary to rinse several times.

The solution is dispensed into suitable aliquots which are stored at -20°C.



### 0.1M H<sub>2</sub>SO<sub>4</sub>

Molarity: 0.1M

#### Reagents

H<sub>2</sub>SO<sub>4</sub> (95-97%)

Method	Amount	Final conc.
H <sub>2</sub> SO <sub>4</sub>	5.5mL	0.1M

Milli-Q-H<sub>2</sub>O to 1000mL

Pour approx. 800mL Milli-Q-H<sub>2</sub>O into a flask. Add the H<sub>2</sub>SO<sub>4</sub>, mix well and make up to 1000mL with Milli-Q-H<sub>2</sub>O

#### Remember

Add acid to water.

### 3M K<sub>2</sub>HPO<sub>4</sub>

Molarity: 3M

#### Reagents

K<sub>2</sub>HPO<sub>4</sub> · 3H<sub>2</sub>O

Method	Amount	Final conc.
K <sub>2</sub> HPO <sub>4</sub> · 3H <sub>2</sub> O	329.29g	3M

Milli-Q water to 500mL

The required weight of salt is added to approx. 300mL Milli-Q water Dissolve on a magnetic stirrer. Make up to 500mL

#### Comments

The material is slow to dissolve.

### 1M NaOH

Molarity: 1M

#### Reagents

NaOH

Method	Amount	Final conc.
NaOH	40g	1M

Milli-Q-H<sub>2</sub>O to 1000mL

Pour approx. 900mL into a glass bottle  
Add NaOH pellets and allow them to dissolve  
Make up to 1000mL with Milli-Q-H<sub>2</sub>O

#### Comments

NB! The dissolution process is exothermic.  
The liquid becomes very warm.

### 10mg/mL BSA

#### Reagents

Bovine Albumin (BSA)

Method	Amount	Final conc.
BSA	0.5g	10mg/mL

Deionised water to 50mL  
Dissolve at room temperature

#### Comments

Pour the water into a suitable beaker. Place the BSA on the surface, wait until the crystals sink into liquid. Stir gently with a magnetic stirrer. Avoid the creation of froth as much as possible.

Store in 1mL aliquots in 1.8mL CryoTube™ vials at -20°C.

### 1.5% Tween 20 surfactant

#### Reagents

Tween 20 surfactant

Method	Amount	Final conc.
Tween 20 surfactant	0.75mL	1.5%

Deionised water to 50mL

#### Comments

Tween 20 surfactant is dispersed using a Vortex mixer.  
Dispensed in 1mL aliquots in 1-1.8mL CryoTube vials.  
Store at -20°C.

# Speed up your process

with Thermo Scientific Microplate Readers

## Thermo Scientific Multiskan FC

The Multiskan® FC microplate photometer is an easy to use ELISA reader for research and routine applications.



## Thermo Scientific Multiskan GO

The Multiskan® GO spectrophotometer is a UV/Vis microplate and cuvette reader which offers free wavelength selection for both 96 and 384 well plates and various types of cuvettes.



## Thermo Scientific Fluoroskan Ascent FL

The Fluoroskan® Ascent FL microplate reader is for both glow and flash luminometric and fluorometric research applications.



## Thermo Scientific Varioskan Flash

The Varioskan® Flash spectral scanning multimode reader provides flexibility for a variety of different fluorescence intensity, TRF, photometric and luminescence based applications.



## Working in a high-throughput application?

The Thermo Scientific Proteomics product line offers a custom plate-coating service as well as large-volume quantities of substrates, fluorescent dyes, wash and blocking buffers, catalog and custom antibodies, and secondary detection reagents.

For more information please visit [www.thermoscientific.com/protein-custom](http://www.thermoscientific.com/protein-custom)



To help you find the best product for your application

Please visit our online **plate selection tool**

[www.thermoscientific.com/plateguide](http://www.thermoscientific.com/plateguide)



© 2011 Thermo Fisher Scientific Inc. All rights reserved. "Tween" is a registered trademark of Uniqema Americas; "Triton" is a registered trademark of Dow Chemical Company; and "Immobilizer" is a trademark of Exiqon A/S, Vedbaek, Denmark. The product is produced under license from Exiqon A/S - EP 0820483 and foreign applications and patents. All other trademarks are the property of Thermo Fisher Scientific Inc. and its subsidiaries.

[www.thermoscientific.com/pierce-custom](http://www.thermoscientific.com/pierce-custom)

**Asia:** China Toll-free: 800-810-5118 or 400-650-5118; India: +91 22 6716 2200, India Toll-free: 1 800 22 8374; Japan: +81 3 5826 1616; Other Asian countries: 65 68729717  
**Europe:** Austria: +43 1 801 40 0; Belgium: +32 53 73 42 41; Denmark: +45 4631 2000; France: +33 2 2803 2180; Germany: +49 6184 90 6940, Germany Toll-free: 08001-536 376; Italy: +39 02 02 95059 or 434-254-375; Netherlands: +31 76 571 4440; Nordic/Baltic countries: +358 9 329 100; Russia/CIS: +7 (812) 703 42 15; Spain/Portugal: +34 93 223 09 18; Switzerland: +41 44 454 12 12; UK/Ireland: +44 870 609 9203  
**North America:** USA/Canada +1 585 586 8800; USA Toll-free: 800 625 4327  
**South America:** USA sales support: +1 585 899 7198  
**Countries not listed:** +49 6184 90 6940 or +33 2 2803 2180

TILSPSOLIDPHASE 0611

**Thermo**  
SCIENTIFIC

Part of Thermo Fisher Scientific